

ARTICLE 4. **DEVELOPMENT STANDARDS**

[FORM - FRONTAGE - **STANDARDS**] [USE - DENSITY]

Part 4A. **Introduction**

Part 4B. **Development Standards Districts**

Part 4C. **Development Standards Rules**

CONTENTS

Part 4A.	Introduction	4-3
Div. 4A.1.	Orientation	4-4
Div. 4A.2.	Opening Provisions	4-7
Part 4B.	Development Standards Districts	4-9
Div. 4B.1.	District 1	4-10
Div. 4B.2.	District 2	4-10
Div. 4B.3.	District 3	4-10
Div. 4B.4.	District 4	4-10
Div. 4B.5.	District 5	4-11
Div. 4B.6.	District 6	4-12
Part 4C.	Development Standards Rules	4-13
Div. 4C.1.	Pedestrian Access	4-15
Div. 4C.2.	Automobile Access	4-28
Div. 4C.3.	Bicycle Parking	4-42
Div. 4C.4.	Automobile Parking	4-55
Div. 4C.5.	Transportation Demand Management	4-93
Div. 4C.6.	Plants	4-98
Div. 4C.7.	Fences & Walls	4-109
Div. 4C.8.	Screening	4-114
Div. 4C.9.	Grading & Retaining Walls	4-128
Div. 4C.10.	Outdoor Lighting & Glare	4-131
Div. 4C.11.	Signs	4-134
Div. 4C.12.	Site Elements	4-169
Div. 4C.13.	Environmental Protection	4-189
Div. 4C.14.	Development Review	4-190

PART 4A. INTRODUCTION

Div. 4A.1. Orientation	4-4
Sec. 4A.1.1. Relationship to Zone String	4-4
Sec. 4A.1.2. How to Use Article 4 (Development Standards)	4-4
Sec. 4A.1.3. Development Standards District Naming Convention	4-6
Div. 4A.2. Opening Provisions	4-7
Sec. 4A.2.1. Development Standards Intent	4-7
Sec. 4A.2.2. Development Standards Applicability	4-7

DIV. 4A.1. **ORIENTATION**

SEC. 4A.1.1. **RELATIONSHIP TO ZONE STRING**

A zone string is composed of the following districts:



The Development Standards District is a separate and independent component of each zone.

SEC. 4A.1.2. **HOW TO USE ARTICLE 4 (DEVELOPMENT STANDARDS)**

A. **Identify the Applied Development Standards District**

The third component in a zone string identifies the Development Standards District applied to a property.

B. **Development Standards District Regulations**

Development Standards District regulations are located in *Part 4B. (Development Standards Districts)*. Each Development Standards District page identifies the requirements specific to that Development Standards District.

C. **Interpreting Development Standards District Regulations**

Each standard or standards package on a Development Standards District page in *Part 4B. (Development Standards Districts)* provides a reference to *Part 4C. (Development Standards Rules)* where the standard or standards package is explained in detail. Additionally, *Part 4C. (Development Standards Rules)* includes general standards that apply across all Development Standards Districts.

Development Standards District Example:

Zone String

[LM2-MU2-**5**] [RG1-FA]

See Rules that Apply in all Districts

Find Your Development Standards District

Part 4B (Development Standards Districts)

DIV. 4B.5. DISTRICT 5

SEC. 4B.5.1. INTENT

Development Standards District 5 prioritizes the pedestrian experience. Development Standards District 5 prioritizes the pedestrian experience. Pedestrian access standards facilitate pedestrian circulation by improving pedestrian access from the public realm to the interior of buildings through frequent, direct and convenient access to building entrances. Parking for automobiles is not mandated, contributing to a dynamic and walkable environment. When parking is provided, it must meet high design standards to ensure pedestrian mobility, safety, and comfort are not hindered. On-site signs are sized and located to support a pedestrian-oriented public realm.

SEC.	Name of Standard	STANDARDS	Specification for Standard
	PEDESTRIAN ACCESS		Div. 4C.1
	Pedestrian access package		Package 1
	AUTOMOBILE ACCESS		Div. 4C.2
	Automobile access package		Package 1
	AUTOMOBILE PARKING		Div. 4C.4
	Required parking stalls		Package A
	Exempt change of use, non residential tenant size (max)		n/a
	Parking structure design		Primary St. Side St.
	Parking Garage		
	• Ground Story	Wrapped	Wrapped
	• Upper Stories	Adaptable	Adaptable
	• Integrated Parking		
	• Ground Story	Wrapped	Wrapped
	• Upper Stories	Wrapped	Adaptable
	SIGNS		Div. 4C.11
	Sign package		2
	DEVELOPMENT REVIEW		Div. 4C.14
	Development review threshold		Package 2

See Part 4C, (Development Standards Rules) for additional development standards that apply.

Link to Rules

Standard Does Not Apply

Frontage Lot Line

Learn More About Your Rules

Part 4C (Development Standards Rules)

Div. 4C.4. AUTOMOBILE PARKING

SEC. 4C.4.1. AUTOMOBILE PARKING STALLS

A. Intent

To accommodate the arrival to a site by automobile at a level appropriate to the demand generated by a particular use within different mobility contexts without creating detrimental effects on surrounding properties or public right-of-way.

B. Applicability

Required automobile parking stall standards apply all uses on a lot.

C. Standards

1. General

- All uses subject to the parking requirements of this Division must provide the minimum number of automobile parking stalls for the applicable parking use. A, B, C, D or E (Part 4B, (Development Standards Districts)), specifies the applicable parking use requirement for each zone.
- When a site or lot is used for a combination of uses, the parking requirements are the sum of the requirements for each use, and no parking stall for one use may be included in the calculation of parking requirements for any other use, except as allowed in [Sec. 4C.4.2.C.2. (Reduction for Shared Parking)].
- For electric vehicle charging space requirements, see the Green Building Code (LAMC, Chapter 9, Article 9).

2. Required Automobile Parking Table

- When the Required Automobile Parking Table lists multiple parking stall requirement options, the greater number of required parking stalls is required.
- Use are defined in Part 5D.0. Use Definitions.

Except for standards specified by the Development Standards District, standards in Part 4C apply to all lots according to the corresponding applicability statement.

SEC. 4A.1.3. **DEVELOPMENT STANDARDS DISTRICT NAMING CONVENTION**

All Development Standards District names are identified as a number. All Development Standards Districts are numbered in the order they fall within this Article.

DIV. 4A.2. OPENING PROVISIONS

SEC. 4A.2.1. DEVELOPMENT STANDARDS INTENT

The intent of Article 4 (Development Standards) is to regulate site design, including location and characteristics of access, parking, landscape and other site features. Development Standards Districts consist of a combination of regulations that are appropriate to a variety of contexts ranging from auto-oriented to pedestrian-oriented.

SEC. 4A.2.2. DEVELOPMENT STANDARDS APPLICABILITY

A. General

All projects filed after the effective date of this Zoning Code (Chapter 1A) shall comply with the Development Standards Districts and Rules in this Article, as further specified below. For vested rights, see *Sec. 1.4.5. (Vested Rights)*, and for continuance of existing development, see *Sec. 1.4.6. (Continuance of Existing Development)*.

B. Project Activities

Categories of Development Standards rules apply to a project based on what types of project activities are proposed, as shown in the table below. Typically, more than one project activity will apply to a proposed project (for example, an addition that expands an existing use includes both new construction and a use modification).

DEVELOPMENT STANDARDS RULES CATEGORIES		PROJECT ACTIVITIES								
		New Construction	Major Demolition	Lot Modification	Site Modification	Facade Modification	Use Modification	Temporary Use	Renovation	Maintenance & Repair
<i>Div. 4C.1.</i>	Pedestrian Access	●	●	●	●	●	○	○	○	○
<i>Div. 4C.2.</i>	Automobile Access	●	●	●	●	○	○	○	○	○
<i>Div. 4C.3.</i>	Bicycle Parking	●	●	○	●	○	●	○	○	○
<i>Div. 4C.4.</i>	Automobile Parking	●	●	○	●	○	●	○	○	○
<i>Div. 4C.5.</i>	TDM	●	○	○	●	○	●	○	○	○
<i>Div. 4C.6.</i>	Plants	●	○	●	●	○	○	○	○	○
<i>Div. 4C.7.</i>	Fences & Walls	●	●	●	●	○	●	○	○	○
<i>Div. 4C.8.</i>	Screening	●	●	●	●	○	●	○	○	○
<i>Div. 4C.9.</i>	Grading	●	●	●	●	○	○	○	○	○
<i>Div. 4C.10.</i>	Outdoor Lighting & Glare	●	●	○	●	●	○	○	○	○
<i>Div. 4C.11.</i>	Signs	●	●	●	●	●	●	○	○	○
<i>Div. 4C.12.</i>	Site Elements	●	●	○	●	●	●	○	○	○
<i>Div. 4C.13.</i>	Environmental Protection	●	●	○	●	○	○	○	○	○
<i>Div. 4C.14.</i>	Development Review	●	○	●	●	●	●	○	○	○

● = Rules generally apply to this project activity
 ○ = Rules are not applicable

1. Project activities are defined in *Sec. 14.1.15. (Project Activities)*.
2. Where a category of Development Standards rules is listed as generally applicable in the table above, the project activity shall meet all applicable Development Standards standards within the Division. This general applicability may be further specified for each standard in the applicability provisions in *Part 4C. (Development Standards Rules)*. Project applicability may also be modified by *Article 12. (Nonconformities)*. Where a category of Development Standards rules is listed as not applicable in the table above, no standards from that Development Standards Rule category apply to the project activity.

C. **Nonconformity**

Article 12. (Nonconformity) provides relief from the requirements of Article 4 (Development Standards) for existing lots, site improvements, buildings, structures, and uses that conformed to the zoning regulations, if any, at the time they were established, but do not conform to current district standards or use permissions. No project activity may decrease conformance with any Development Standard regulation unless otherwise specified by *Division 12.4. (Development Standards Exceptions)*. Consider the following examples:

1. Extending a fence in a side yard: Where the existing, legally established fence located in a side yard is taller than the maximum height allowed by the fences and walls type specified by the applicable Frontage District, all new portions of fence built in the front yard have to meet the maximum fence and wall height standard, but no existing fence alteration is required.
2. Converting parking stalls to outdoor dining: Where the proposed site alteration and change of use reduces the amount of parking below the number of parking stalls specified by the applicable Development Standards District, the conversion is not allowed.

D. **Applicable Components of Lots and Structures**

1. Development Standards Districts apply to all portions of a lot.
2. Development Standards Districts apply to all portions of buildings and structures on a lot.
3. Specific Development Standards District standards and rules may further limit which components of structures and lots are required to comply with the rules in *Part 4C. (Development Standards Rules)*.

PART 4B. DEVELOPMENT STANDARDS DISTRICTS

- Div. 4B.1. District 1 4-10**
- Div. 4B.2. District 2 4-10**
- Div. 4B.3. District 3 4-10**
- Div. 4B.4. District 4 4-10**
- Div. 4B.5. District 5 4-11**
 - Sec. 4B.5.1. Intent 4-11
 - Sec. 4B.5.2. Standards. 4-11
- Div. 4B.6. District 6 4-12**
 - Sec. 4B.6.1. Intent 4-12
 - Sec. 4B.6.2. Standards. 4-12

- District 1 -

DIV. 4B.1. **DISTRICT 1**

[Reserved]

DIV. 4B.2. **DISTRICT 2**

[Reserved]

DIV. 4B.3. **DISTRICT 3**

[Reserved]

DIV. 4B.4. **DISTRICT 4**

[Reserved]

DIV. 4B.5. DISTRICT 5

SEC. 4B.5.1. INTENT

Development Standards District 5 prioritizes the pedestrian experience. Development Standards District 5 prioritizes the pedestrian experience. Pedestrian access standards facilitate pedestrian circulation by improving pedestrian access from the public realm to the interior of buildings through frequent, direct and convenient access to building entrances. Parking for automobiles is not mandated, contributing to a dynamic and walkable environment. When parking is provided, it must meet high design standards to ensure pedestrian mobility, safety, and comfort are not hindered. On-site signs are sized and located to support a pedestrian-oriented public realm.

SEC. 4B.5.2. STANDARDS

PEDESTRIAN ACCESS	<i>Div. 4C.1.</i>	
Pedestrian access package	Package 1	
AUTOMOBILE ACCESS	<i>Div. 4C.2.</i>	
Automobile access package	Package 1	
AUTOMOBILE PARKING	<i>Div. 4C.4.</i>	
Required parking stalls	Package A	
Change of use parking exemption (max)	n/a	
Parking structure design	Primary St.	Side St.
Parking Garage		
Ground Story	Wrapped	Wrapped
Upper Stories	Adaptable	Adaptable
Integrated Parking		
Ground Story	Wrapped	Wrapped
Upper Stories	Wrapped	Adaptable
SIGNS	<i>Div. 4C.11.</i>	
Sign package	2	
DEVELOPMENT REVIEW	<i>Div. 4C.14.</i>	
Development review threshold	Package 2	

See Part 4C. (Development Standards Rules) for additional development standards that apply.

DIV. 4B.6. DISTRICT 6

SEC. 4B.6.1. INTENT

Development Standards District 6 enables the flexibility needed for a diversity of industries with changing demands. Standards for automobile access are permissive and parking minimums are not mandated.

SEC. 4B.6.2. STANDARDS

PEDESTRIAN ACCESS	<i>Div. 4C.1.</i>	
Pedestrian access package	Package 4	
AUTOMOBILE ACCESS	<i>Div. 4C.2.</i>	
Automobile access package	Package 3	
AUTOMOBILE PARKING	<i>Div. 4C.4.</i>	
Required parking stalls	Package A	
Change of use parking exemption (max)	n/a	
Parking structure design	Primary St.	Side St.
Parking Garage		
Ground Story	Concealed	Concealed
Upper Stories	Concealed	Concealed
Integrated Parking		
Ground Story	Concealed	Concealed
Upper Stories	Concealed	Concealed
SIGNS	<i>Div. 4C.11</i>	
Sign package	1	
DEVELOPMENT REVIEW	<i>Div. 4C.14.</i>	
Development review threshold	Package 1	

See Part 4C. (Development Standards Rules) for additional development standards that apply to all Development Standards Districts.

PART 4C. DEVELOPMENT STANDARDS RULES

Div. 4C.1. Pedestrian Access	4-15
Sec. 4C.1.1. Pedestrian Access Packages	4-15
Sec. 4C.1.2. Pedestrian Bridges & Tunnels.	4-26
Div. 4C.2. Automobile Access	4-28
Sec. 4C.2.1. Automobile Access Packages	4-28
Sec. 4C.2.2. Motor Vehicle Use Area Design	4-36
Div. 4C.3. Bicycle Parking	4-42
Sec. 4C.3.1. Bicycle Parking Spaces	4-42
Sec. 4C.3.2. Short-Term Bicycle Parking Design	4-45
Sec. 4C.3.3. Long-Term Bicycle Parking Design	4-51
Div. 4C.4. Automobile Parking.	4-55
Sec. 4C.4.1. Automobile Parking Stalls.	4-55
Sec. 4C.4.2. Change of Use Parking Exemption.	4-63
Sec. 4C.4.3. Alternative Parking Strategies	4-65
Sec. 4C.4.4. Parking Area Design	4-69
Sec. 4C.4.5. Parking Lot Design	4-76
Sec. 4C.4.6. Parking Structure Design	4-81
Div. 4C.5. Transportation Demand Management	4-93
Sec. 4C.5.1. Small Projects	4-93
Sec. 4C.5.2. Medium Projects.	4-94
Sec. 4C.5.3. Large Projects	4-96
Div. 4C.6. Plants	4-98
Sec. 4C.6.1. Protected Vegetation	4-98
Sec. 4C.6.2. Required Trees	4-98
Sec. 4C.6.3. Streetscape.	4-100
Sec. 4C.6.4. Plant Design & Installation	4-100
Div. 4C.7. Fences & Walls	4-109
Sec. 4C.7.1. Frontage Yard Fences & Walls	4-109
Sec. 4C.7.2. Side/Rear Yard Fences & Walls	4-109
Sec. 4C.7.3. Fence/Wall Design & Installation.	4-113

Div. 4C.8. Screening	4-114
Sec. 4C.8.1. Frontage Screens	4-114
Sec. 4C.8.2. Transition Screens	4-120
Sec. 4C.8.3. Outdoor Storage.	4-125
Div. 4C.9. Grading & Retaining Walls.	4-128
Sec. 4C.9.1. Grading & Hauling	4-128
Sec. 4C.9.2. Retaining Walls.	4-129
Div. 4C.10. Outdoor Lighting & Glare	4-131
Sec. 4C.10.1. Outdoor Lighting	4-131
Sec. 4C.10.2. Glare	4-132
Div. 4C.11. Signs	4-134
Sec. 4C.11.1. General Sign Rules.	4-134
Sec. 4C.11.2. Temporary Signs.	4-141
Sec. 4C.11.3. Off-Site Signs	4-143
Sec. 4C.11.4. On-Site Signs.	4-147
Sec. 4C.11.5. Sign Packages	4-149
Sec. 4C.11.6. Sign Types	4-152
Div. 4C.12. Site Elements.	4-169
Sec. 4C.12.1. Roof-Mounted Equipment	4-169
Sec. 4C.12.2. Ground-Mounted Equipment	4-171
Sec. 4C.12.3. Wall-Mounted Equipment	4-175
Sec. 4C.12.4. Wireless Telecommunication Facilities	4-177
Sec. 4C.12.5. Waste Receptacles	4-180
Sec. 4C.12.6. Recycling Areas	4-182
Sec. 4C.12.7. Shopping Cart Containment	4-186
Div. 4C.13. Environmental Protection.	4-189
Sec. 4C.13.1. Environmental Protection Measures	4-189
Div. 4C.14. Development Review.	4-190
Sec. 4C.14.1. Development Review Threshold Packages.	4-190

DIV. 4C.1. **PEDESTRIAN ACCESS**

SEC. 4C.1.1. **PEDESTRIAN ACCESS PACKAGES**

A. **Intent**

To promote walkability, improve pedestrian access from the public realm to the interior of buildings, ensure that required entrances are conveniently and effectively accessible to pedestrians, and activate the public realm with building access points and improve convenient pedestrian circulation through large sites to an extent and frequency appropriate to the context.

B. **Applicability**

Applicable pedestrian access standards are determined by the pedestrian access package assigned by the applicable Development Standards District.

1. **Site Access**

Site access standards apply to street-facing entrances required by the applicable Frontage District and all frontage yards. Site access standards do not apply to non-required entrances.

2. **Through Access**

- a. Through access standards apply only to projects that include one or more of the following project activities:
 - i. Site modification; and
 - ii. New construction.
- b. Through access standards apply only to lots that meet all of the following conditions:
 - i. Lot area greater than 30,000 square feet,
 - ii. Lot width equal to or greater than the pedestrian passageway spacing minimum required by the pedestrian access package assigned by the applicable Development Standards District, and
 - iii. Lot is a through lot or abuts either a public right-of-way, publicly accessible easement, or a lot zoned with an Open Space Use District on at least two opposing lot lines.

C. **Standards**

1. Pedestrian Access Packages

A combination of standards regulating pedestrian access from the public sidewalk into and through a site.

a. Pedestrian Access Package 1

Intended to ensure buildings are highly integrated with the surrounding public realm and promote walking as a safe and convenient mobility option through frequent physical connections between the public realm and the interior of a building and improved porosity through large sites.

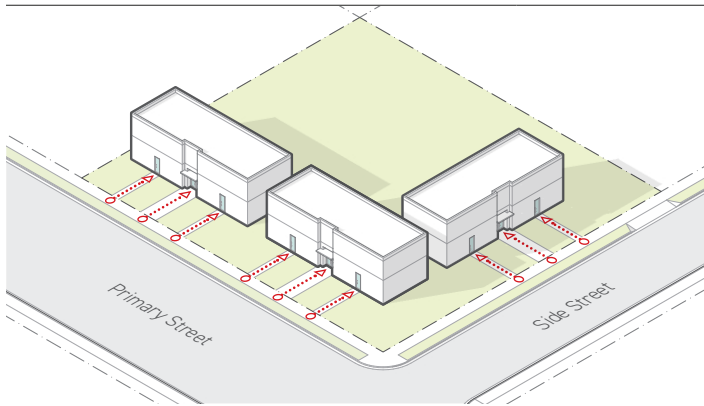

SITE ACCESS		Sec. 4C.1.1.C.2.
Pedestrian accessway type	Direct	
Pedestrian accessway spacing (max)	n/a	
Distance from street intersection (max)	n/a	
THROUGH ACCESS		Sec. 4C.1.1.C.3.
Pedestrian passageway	Required	
Pedestrian passageway spacing (max)	350'	

b. Pedestrian Access Package 2

Intended to ensure buildings are conveniently accessible from the public realm and promote walking as a safe and convenient mobility option through regular physical connections between the public realm and the interior of a building and improved porosity through very large sites.

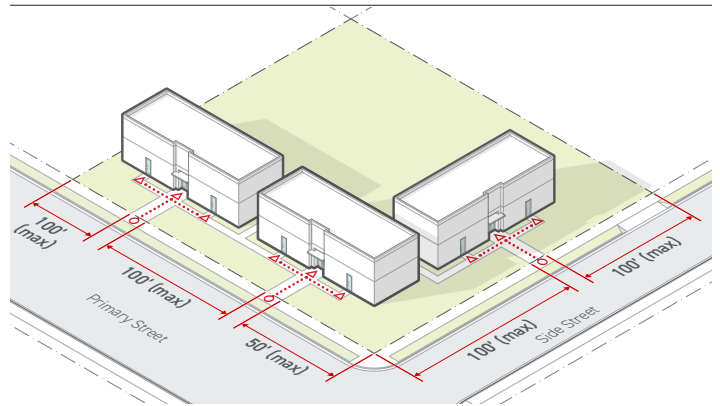

SITE ACCESS		Sec. 4C.1.1.C.2.
Pedestrian accessway type	Linked	
Pedestrian accessway spacing (max)	100'	
Distance from street intersection (max)		
Primary street	50'	
Side street	100'	
THROUGH ACCESS		Sec. 4C.1.1.C.3.
Pedestrian passageway	Required	
Pedestrian passageway spacing (max)	600'	

c. Pedestrian Access Package 3

Intended to ensure buildings are accessible from the public realm and promote walking as a safe mobility option through intermittent physical connections between the public realm and the interior of a building.

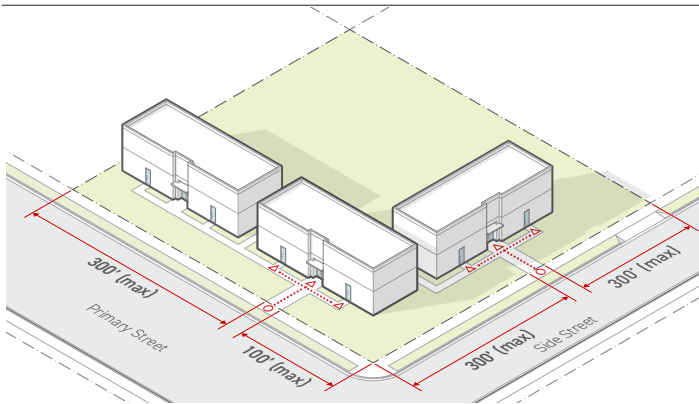

SITE ACCESS	<i>Sec. 4C.1.1.C.2.</i>
Pedestrian accessway type	Linked
Pedestrian accessway spacing (max)	300'
Distance from street intersection (max)	
Primary street	100'
Side street	300'
THROUGH ACCESS	<i>Sec. 4C.1.1.C.3.</i>
Pedestrian passageway	Not required
Pedestrian passageway spacing (max)	n/a

d. Pedestrian Access Package 4

Intended to ensure buildings are accessible from the public realm by requiring a physical connection between the public realm and the interior of a building.

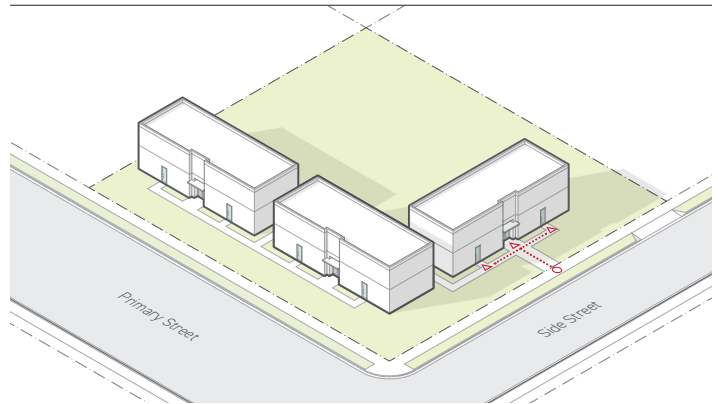

SITE ACCESS	<i>Sec. 4C.1.1.C.2.</i>
Pedestrian accessway type	Linked
Pedestrian accessway spacing (max)	1 per lot
Distance from street intersection (max)	n/a
THROUGH ACCESS	<i>Sec. 4C.1.1.C.3.</i>
Pedestrian passageway	Not required
Pedestrian passageway spacing (max)	n/a

2. Site Access

a. Pedestrian Accessway Type

i. Linked

Where the applicable package in *Sec. 4C.1.1.C.1. (Pedestrian Access Package)* specifies linked as the pedestrian accessway type, all required pedestrian accessways shall meet the following standards:

- a) Shall be a minimum width of 4 feet.
- b) Shall connect from the sidewalk, or other publicly accessible pedestrian facility along the applicable frontage lot line, to a street-facing entrance required by the applicable Frontage District within the frontage yard.
- c) Shall be physically separated from and uninterrupted by motor vehicle use areas except where required to cross a drive aisle. Drive aisle crossings shall be no wider than the minimum drive aisle width specified in *Sec. 4C.4.4.C.14. (Parking Bay Dimensions)*. Physical separation methods may include, curbs of no less than 4 inches in height or bollards, walls, raised planters or similar containment methods, no less than 30 inches in height and separated by no more than 5 feet.

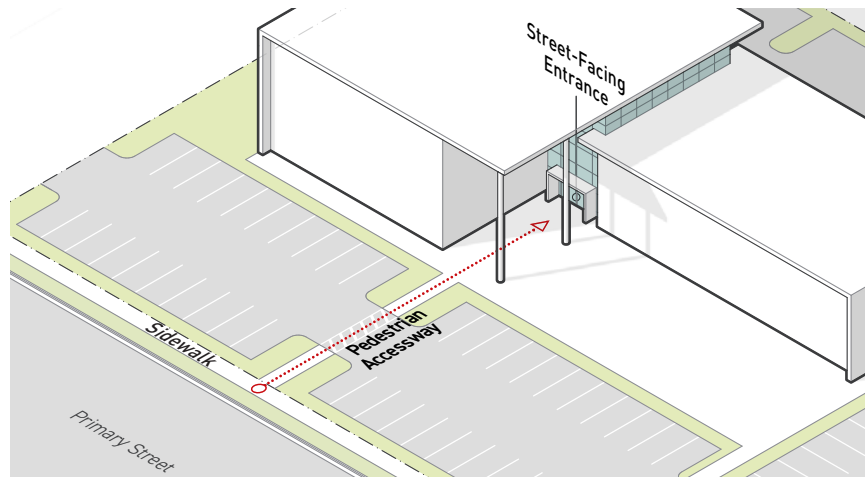

- d) Where a retaining wall, open drainage, or similar obstacle interrupts a required pedestrian accessway, the pedestrian accessway shall be designed to facilitate passage through or over the obstacle.

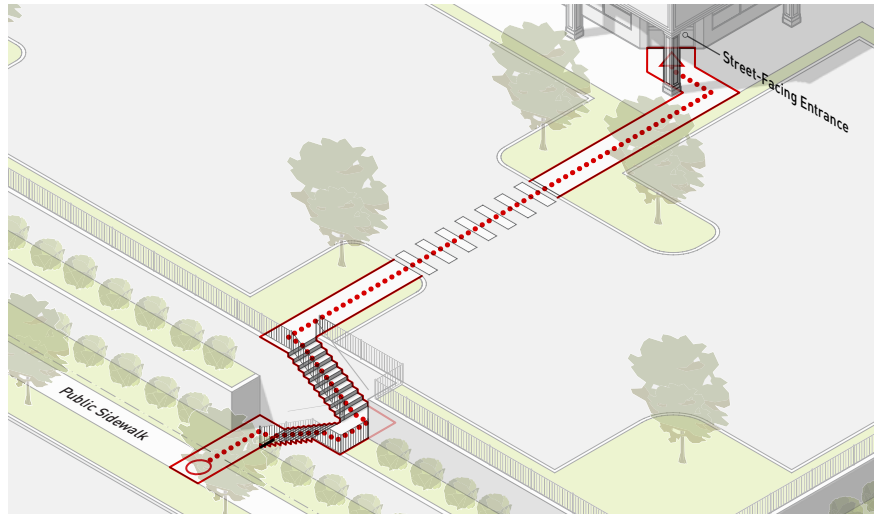

ii. **Direct**

Direct pedestrian accessways shall meet following standards:

- a) Comply with *Sec. 4C.1.1.C.2.a.i. (Linked Pedestrian Accessway Type)*.
- b) A minimum of one pedestrian accessway shall be provided to each street-facing entrance required by the applied *Frontage District (Part 3B)*.
- c) All portions of the accessway including the connection to the public sidewalk shall be within 25 feet of the center of the street-facing entrance, measured parallel to the frontage lot line.

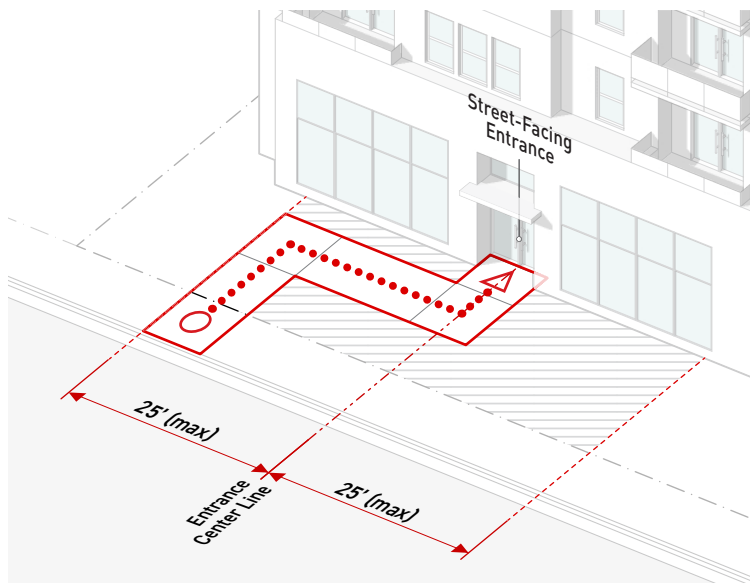

b. Pedestrian Accessway Spacing

A required pedestrian accessway shall not be separated from another pedestrian accessway or the end of a frontage lot line by a distance greater than the maximum allowed pedestrian accessway spacing standard in *Sec. 4C.1.1.C.1. (Pedestrian Access Package)*.

c. Distance from Street Intersection

A pedestrian accessway shall not be separated from a street intersection by a distance greater than the maximum allowed distance from intersection standard in *Sec. 4C.1.1.C.1. (Pedestrian Access Package)*.

3. Through Access

a. Pedestrian Passageway

When a pedestrian passageway is required by *Sec. 4C.1.1.C.1. (Pedestrian Access Package)*, a pedestrian passageway shall provide a passageway meeting the following requirements:

- i. Minimum width of 15 feet for uncovered portions and a minimum width of 25 feet for covered portions.
- ii. Minimum clear height of 15 feet, with the exception of required luminaires.

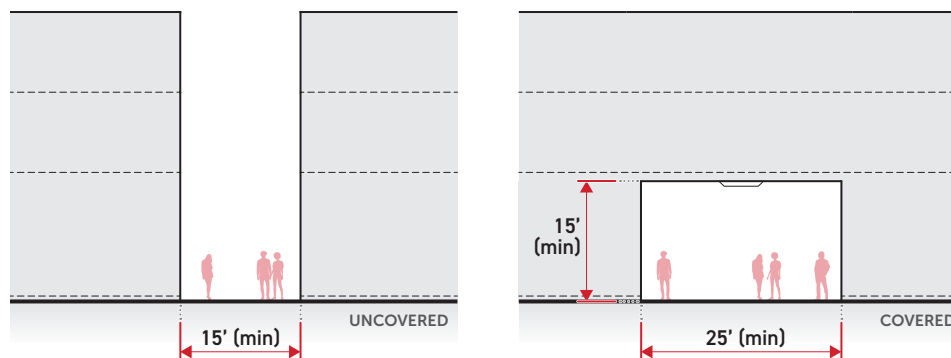

- iii. For pedestrian passageways having a clear height of less than 30 feet for any portion of its required minimum width, a maximum of 125 linear feet of the total passageway may be covered for any portion of the required minimum width, measured cumulatively.

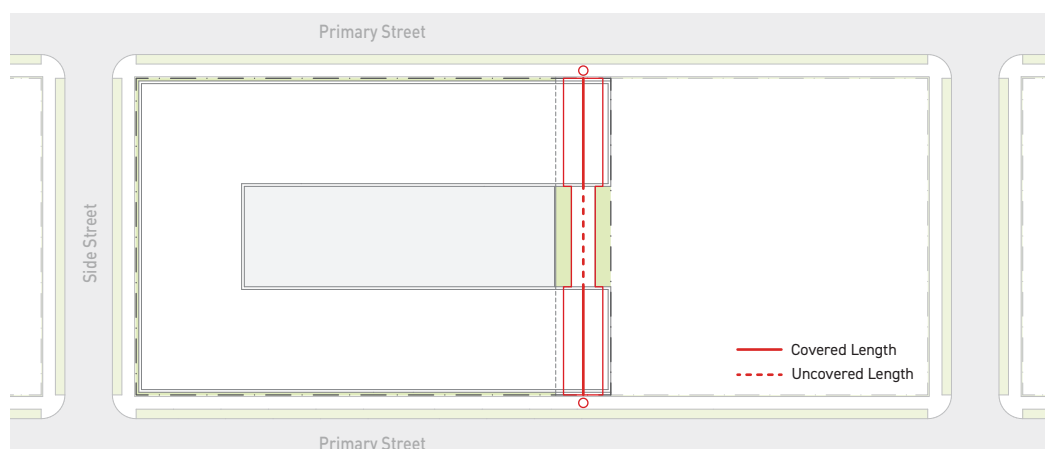

a pedestrian passageway from pedestrian access during the required available hours, and a sign shall be posted at every public entrance to the pedestrian passageway in accordance with the standards in *Sec. 2C.3.3.D.10.b.ii.*

xii. Each facade facing the pedestrian passageway shall meet the side street transparency and entrance standards of the applied *Frontage District (Part 3B)*. For the purposes of determining which facades shall be considered as facing the pedestrian passageway, the pedestrian passageway shall be considered a pedestrian amenity space and measured in accordance with *Sec. 14.1.6.C. (Pedestrian Amenity-Facing Facade)*.

xiii. Pedestrian passageways may count toward the lot amenity space required by the applied *Form District (Part 2B)* for any portion of the passageway that meets the *Sec. 2C.3.1.C. (Amenity Space Standards)* or may count as pedestrian amenity spaces for any portion of the pedestrian passageway that meets *Sec. 2C.3.1.C. (Lot Amenity Space Standards)*.

4. **Pedestrian Passageway Spacing**

- a. Pedestrian passageways shall not be separated from another pedestrian passageway or the end of a primary street lot line by a distance greater than the maximum allowed pedestrian passageway spacing specified by the applicable Development Standards District.
- b. The maximum pedestrian passageway spacing requirement shall be met for each lot individually and is not applicable to adjacent or abutting lots.

D. **Measurement**

1. **General**

For frontage lot line, see *Sec. 14.1.12 (Lot Line Determination)*.

2. **Pedestrian Accessways**

- a. Pedestrian accessway spacing is measured as the distance between pedestrian accessways measured following the geometry of the frontage lot line from end of lot line to edge of pedestrian accessway and from edge of pedestrian accessway to edge of pedestrian accessway.

- b. Pedestrian accessway distance from a street intersection is measured from the intersection of two street lot lines to the nearest edge of a pedestrian accessway measured along the applicable frontage lot line.

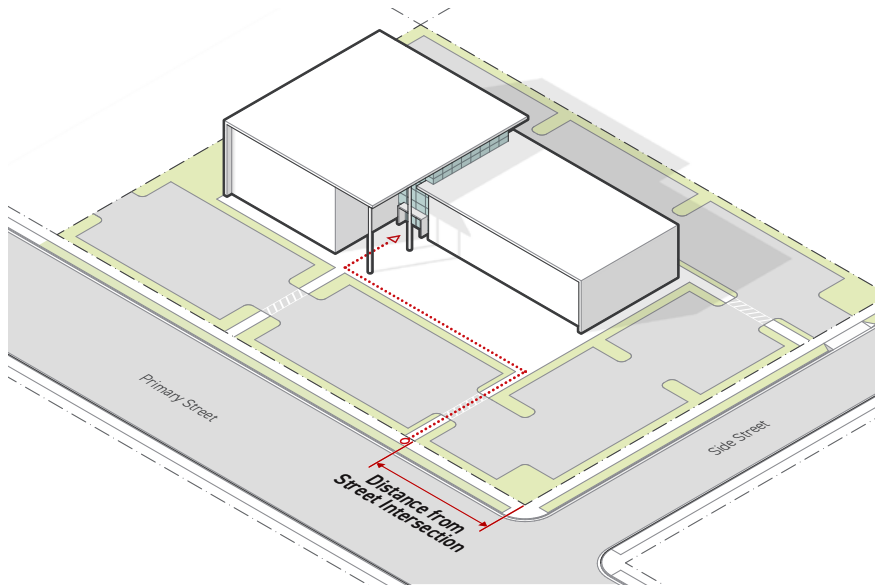

- c. Pedestrian accessway width is measured from one edge of the accessway perpendicularly to the opposite edge.

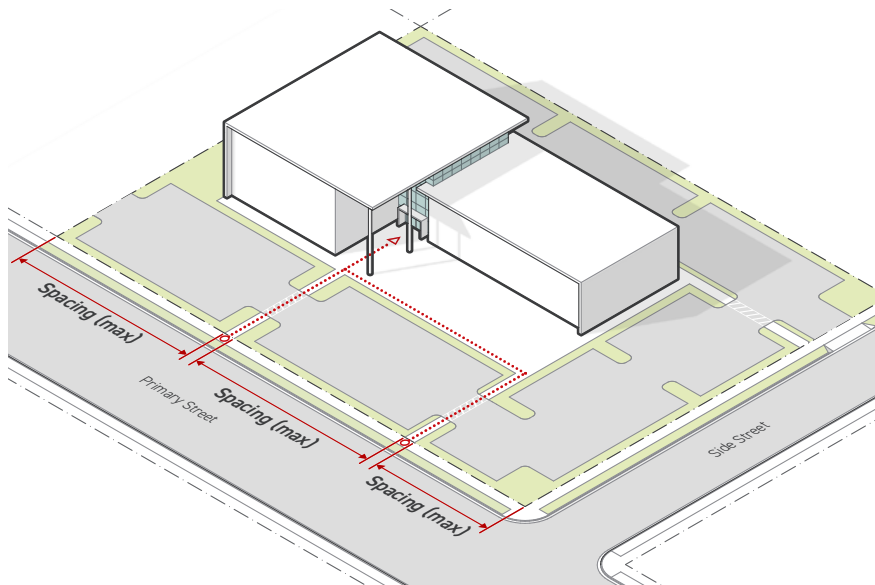

3. Pedestrian Passageways

- a. Pedestrian passageway width is measured from one edge of the designated passageway perpendicularly to the opposite edge of the passageway.
- b. The cumulative linear feet of covered pedestrian passageway is measured along the centerline of the minimum pedestrian passageway width. Where any portion of the minimum width of the pedestrian passageway is not open to the sky, the length of the centerline having covered area perpendicular to it counts as covered length. The total covered length is calculated as the sum of all portions of the centerline considered covered.
- c. Access distance from street intersection is measured from the point where two street lot lines intersect adjacent to a street corner to the nearest edge of a required pedestrian passageway passageway, measured along the primary street lot line.

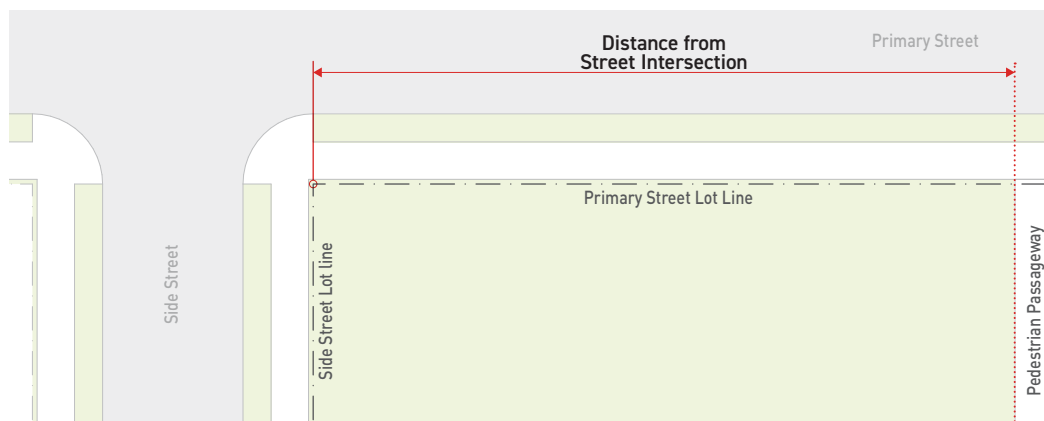

- d. Pedestrian passageway spacing is measured as the horizontal distance between designated pedestrian passageway passageways measured at the primary street lot line from end of lot line to edge of passageway and from edge of passageway to edge of passageway.

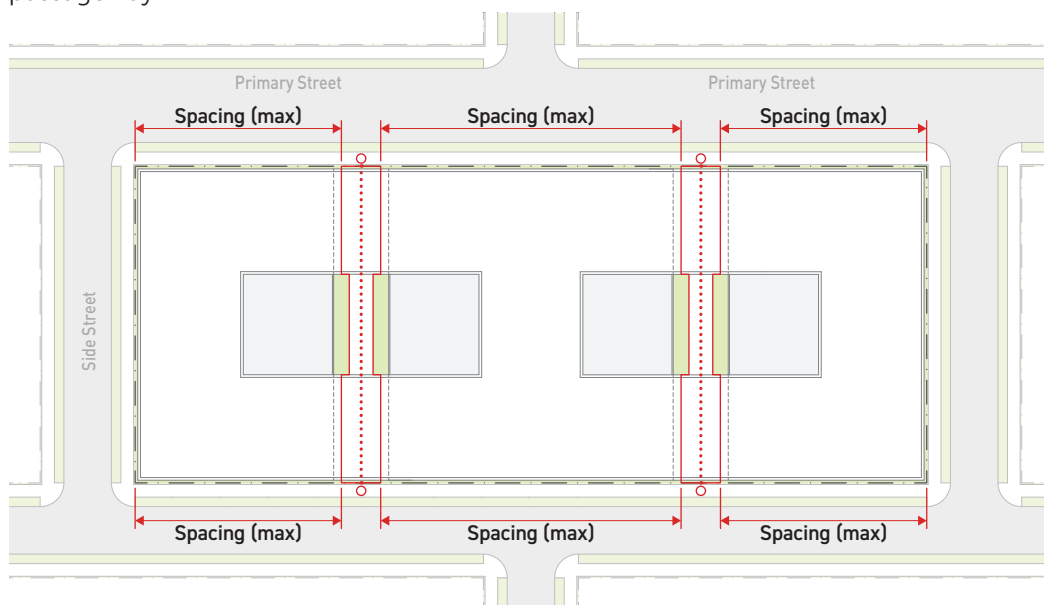

E. Relief

1. A deviation from any pedestrian access standard may be requested in accordance with Sec. 13B.5.1. (*Alternative Compliance*).
2. A deviation from any pedestrian access dimensional standard of up to 10% may be requested in accordance with Sec. 13B.5.2 (*Adjustment*).
3. A deviation from any pedestrian access standard may be allowed as a variance in accordance with Sec. 13B.5.3 (*Variance*).

SEC. 4C.1.2. **PEDESTRIAN BRIDGES & TUNNELS**

A. **Intent**

To limit the creation of new pedestrian bridges and tunnels that create an inhospitable environment for pedestrians at the street level, and to ensure that, in the event pedestrian bridges and tunnels are deemed necessary to the feasibility of a project, that they positively contribute to the public realm and general pedestrian safety.

B. **Applicability**

Pedestrian bridges and tunnels standards are applicable to the new construction of pedestrian bridges and pedestrian tunnels.

C. **Standards**

1. **General**

The construction and operation of a pedestrian bridge or tunnel shall be authorized in accordance with *Sec. 13B.2.5. (Director Determination)*. In addition to the findings otherwise required by *Sec. 13B.2.5. (Director Determination)*, before granting approval, the Director of Planning shall find that the proposed pedestrian bridge or tunnels meets *Sec. 4C.1.2.C.2. (Performance Criteria)* and *Sec. 4C.1.2.C.3. (Justification Criteria)*. Additional conditions of approval may also be applied by the Director of Planning.

2. **Performance Criteria**

The proposed pedestrian bridge or tunnel meets all of the following performance criteria:

- a. The design of the pedestrian bridge or tunnel is visually compatible with buildings involved and the surrounding environment.
- b. The pedestrian bridge or tunnel does not have a detrimental effect on surrounding properties, public right-of-way, or the movement of wildlife.
- c. The pedestrian bridge or tunnel includes features that enhance the streetscape and pedestrian safety.
- d. The pedestrian bridge shall not include exterior signage.
- e. Existing sidewalk widths shall not be reduced.
- f. The pedestrian bridge or tunnel shall not detract from the intended use and activation of the public sidewalk.
- g. The pedestrian bridge or tunnel is not located above any lot zoned with an *Open Space Use District (Div. 5B.1.)*.

3. **Justification Criteria**

The proposed pedestrian bridge or tunnel is justified by one or more of the following criteria:

- a. The pedestrian bridge or tunnel is essential to the viability to one of the following uses:
 - i. Civic
 - ii. School
 - iii. Hospital
 - iv. Convention Center
- b. The pedestrian bridge or tunnel is essential to the health and safety of occupants of the buildings it serves or the general public.
- c. The pedestrian bridge or tunnel is essential to overcome physical constraints, such as grade changes or public infrastructure.

4. **Additional Conditions of Approval**

Additional Conditions of Approval may be imposed by the Director of Planning to ensure pedestrian bridge or tunnel does not detract from the pedestrian experience or have detrimental effect on surrounding properties or public right-of-way.

DIV. 4C.2. **AUTOMOBILE ACCESS**

SEC. 4C.2.1. **AUTOMOBILE ACCESS PACKAGES**

A. **Intent**

To ensure automobile access to sites is designed to support the safety of all users by minimizing conflicts with pedestrians, cyclists, transit vehicles, micro-mobility devices, and automobile traffic on the abutting public right-of-way, and to avoid detrimental effects on the surrounding public realm, while providing sufficient access to automobile parking and motor vehicle use areas.

B. **Applicability**

1. **General**

Automobile access standards are applicable wherever a project provides a driveway from a public right-of-way to a lot. Applicable automobile access standards are in *Sec. 4C.2.1.C.1. (Automobile Access Packages)*, and are assigned by the applicable Development Standards District (Part 4B).

2. **Boulevard or Avenue**

Where Automobile Access Package standards are specified for Boulevard or Avenue, the standards apply to driveways that take access from a street designated as a Boulevard or Avenue, as designated by the applicable community plan circulation map.

3. **Collector or Local**

Where Automobile Access Package standards are specified for Collector or Local, the standards apply to driveways that take access from a street designated as a Collector or Local, as designated by the applicable community plan circulation map.

C. **Standards**

1. Automobile Access Packages

A combination of standards regulating automobile access between the public roadway and a site.

a. Automobile Access Package 1

Intended for areas where walking, bicycling and transit are the prioritized modes of transportation.

	Access Lanes
ACCESS LOCATION	<i>Sec. 4C.2.1.C.3.</i>
Boulevard or Avenue	Limited
Collector or Local	Limited
NUMBER OF ACCESS LANES	<i>Sec. 4C.2.1.C.4.</i>
Boulevard or Avenue	
0'-400' lot width	2
> 400' lot width	4
Collector or Local	
0'-120' lot width	1
120'-400' lot width	2
> 400' lot width	4
Alley	Unlimited
ACCESS LANE WIDTH	<i>Sec. 4C.2.1.C.5.</i>
Boulevard or Avenue (min/max)	9'/12'
Collector or Local (min/max)	8'/12'
DRIVEWAY SEPARATION	<i>Sec. 4C.2.1.C.6.</i>
Boulevard or Avenue	
From intersection (min)	150'
From other driveways (min)	60'
Collector or Local	
From intersection (min)	75'
From other driveways (min)	60'
DRIVE-THROUGHS	<i>Sec. 4C.2.1.C.7.</i>
Drive-through facilities	Not Allowed

See *Sec. 4C.2.2. (Motor Vehicle Use Area Design)* for additional standards that apply.

b. Automobile Access Package 2

Intended for areas where walking, bicycling and transit are balanced with automobiles as the prioritized modes of transportation.

	Access Lanes
ACCESS LOCATION	<i>Sec. 4C.2.1.C.3.</i>
Boulevard or Avenue	Limited
Collector or Local	Limited
NUMBER OF ACCESS LANES	<i>Sec. 4C.2.1.C.4.</i>
Boulevard or Avenue	
0'-200' lot width	2
> 200' lot width	4
Collector or Local	
0'-80' lot width	1
80'-200' lot width	2
> 200' lot width	4
Alley	Unlimited
ACCESS LANE WIDTH	<i>Sec. 4C.2.1.C.5.</i>
Boulevard or Avenue (min/max)	9'/12'
Collector or Local (min/max)	8'/12'
DRIVEWAY SEPARATION	<i>Sec. 4C.2.1.C.6.</i>
Boulevard or Avenue	
From intersection (min)	150'
From other driveways (min)	40'
Collector or Local	
From intersection (min)	75'
From other driveways (min)	40'
DRIVE-THROUGHS	<i>Sec. 4C.2.1.C.7.</i>
Drive-through facilities	Not Allowed

See *Sec. 4C.2.2. (Motor Vehicle Use Area Design)* for additional standards that apply.

c. Automobile Access Package 3

Intended for areas where automobiles are the prioritized mode of transportation.

	Access Lanes
ACCESS LOCATION	<i>Sec. 4C.2.1.C.3.</i>
Boulevard or Avenue	Limited
Collector or Local	Limited
NUMBER OF ACCESS LANES	<i>Sec. 4C.2.1.C.4.</i>
Boulevard or Avenue	
0'-200' lot width	2
> 200' lot width	4
Collector or Local	
0'-200' lot width	2
> 200' lot width	4
Alley	Unlimited
ACCESS LANE WIDTH	<i>Sec. 4C.2.1.C.5.</i>
Boulevard or Avenue (min/max)	9'/16'
Collector or Local (min/max)	8'/16'
DRIVEWAY SEPARATION	<i>Sec. 4C.2.1.C.6.</i>
Boulevard or Avenue	
From intersection (min)	150'
From other driveways (min)	20'
Collector or Local	
From intersection (min)	75'
From other driveways (min)	20'
DRIVE-THROUGHS	<i>Sec. 4C.2.1.C.7.</i>
Drive-through facilities	Allowed

See *Sec. 4C.2.2. (Motor Vehicle Use Area Design)* for additional standards that apply.

2. General

a. Design

All vehicle driveways shall conform to *Sec. 4C.2.2. (Motor Vehicle Use Area Design)*.

b. Access Lane Reservoir Depth

Access lanes designated for ingress traffic shall have a depth no less than the minimum specified in the table below, based on the total number of parking stalls included within the parking facilities that the access lane serves.

DRIVEWAY RESERVOIR DEPTH		
Total Parking Stalls	Driveway Reservoir Depth	
	Boulevard or Avenue	Collector or Local
1-10	20' min	0' min
11-100	20' min	20' min
101-300	40' min	40' min
> 300	60' min	60' min

- i. Vehicle entry restriction devices, such as mechanical gates or ticket dispensers are prohibited within the driveway for the minimum access lane reservoir depth.
- ii. Automobile parking stalls shall not be accessed from the driveway for the minimum access lane reservoir depth.
- iii. Drive aisles shall not be permitted to intersect the driveway within the minimum access lane depth.

3. Access Location

a. Limited

Where an automobile access package specifies "Limited" for any street designation, the following standards apply:

- i. Access lanes shall not take access through primary street lot lines unless the lot does not include a side street lot line or alley lot line through which access can be taken.
- ii. Access lanes shall not take access through side street lot lines unless the lot does not include an alley lot line through which access can be taken.
- iii. For an alley lot line to be considered eligible for automobile access the abutting alley shall have a minimum width of 12 feet.

b. Permitted

Where an automobile access package specifies Permitted for a street designation, access lanes are permitted along the specified street lot line.

4. Number of Access Lanes

The total number of access lanes taking access through a street lot line shall be no greater than the number specified by the assigned *automobile access package* (Sec. 4C.2.1.C.1.) based on the lot width measured along the street lot line abutting the street having the listed street designation.

5. Access Lane Width

Access Lanes shall be no wider than the maximum and no narrower than the minimum width specified by the applicable package in Sec. 4C.2.1.C.1. (*Automobile Access Package*). A driveway may be no wider than the sum of all included access lane widths, excluding gutters of no more than 18 inches wide and curbs.

6. Driveway Separation

a. From Intersection

- i. Driveways shall be separated from all street intersections by a distance no less than the minimum distance specified by the applicable package in Sec. 4C.2.1.C.1. (*Automobile Access Package*), measured parallel to the applicable street lot line.
- ii. Where the intersecting street only interrupts the opposite edge of the subject street right-of-way (ex: 3-way intersection), the following standards apply:
 - a) Where at least one of the intersecting street rights-of-way is not designated as a local street, the driveway shall be located no less than half of the minimum distance specified by the applicable *automobile access package* (Sec. 4C.2.1.C.1.).
 - b) Where both intersecting streets are designated as local streets, no driveway separation from the intersection is required.
- iii. Driveway lanes may only be placed within the minimum street separation from intersection when the lot width is less than 170 feet on a Boulevard or Avenue and 85 feet on a Collector or Local, and driveways are placed along the side lot line located furthest from the street intersection. When there are multiple intersections from which separation is required, driveways shall be placed at the midpoint between the street intersections.

b. From Other Driveways

Driveways shall be separated from all other driveways located on the same street lot line by a distance no less than the minimum distance specified by the applicable package in Sec. 4C.2.1.C.1. (*Automobile Access Package*), measured parallel to the applicable street lot line.

7. Drive-Throughs

- a. Where the assigned automobile access package specifies that drive-through facilities are "not allowed", no drive-through facility may be provided on the lot.
- b. Where the assigned automobile access package specifies that drive-through facilities are "allowed", a drive-through facility may be provided on-site provided they meet the standards for drive-through lanes provided in Sec. 4C.2.2.C.2 (Motor Vehicle Use Area).
- c. Where the assigned automobile access package specifies a Drive-Through Alternative Typology, a drive-through facility may be provided on-site provided it meets the standards provided in Div. 7B.4. (Drive Through).

D. Measurement

1. For determining primary and side street lot lines see *Sec. 14.1.12 (Lot Line Determination)*.
2. Street designation is determined by the applicable community plan circulation map.
3. Number of access lanes is calculated as the total number of access lanes providing access to a lot along an individual street lot line.
4. Driveway separation from intersections is measured following the geometry of the street lot line that the driveway takes access through, from the extension of the curb along the intersecting street to the nearest edge of the driveway.
5. Driveway separation from other driveways located on the same street lot line is measured following the geometry of the street lot line that the driveway takes access through, from edge of driveway to edge of driveway. Driveway separation from other driveways only includes driveways providing access to the subject lot and does not include driveways providing access to surrounding lots.

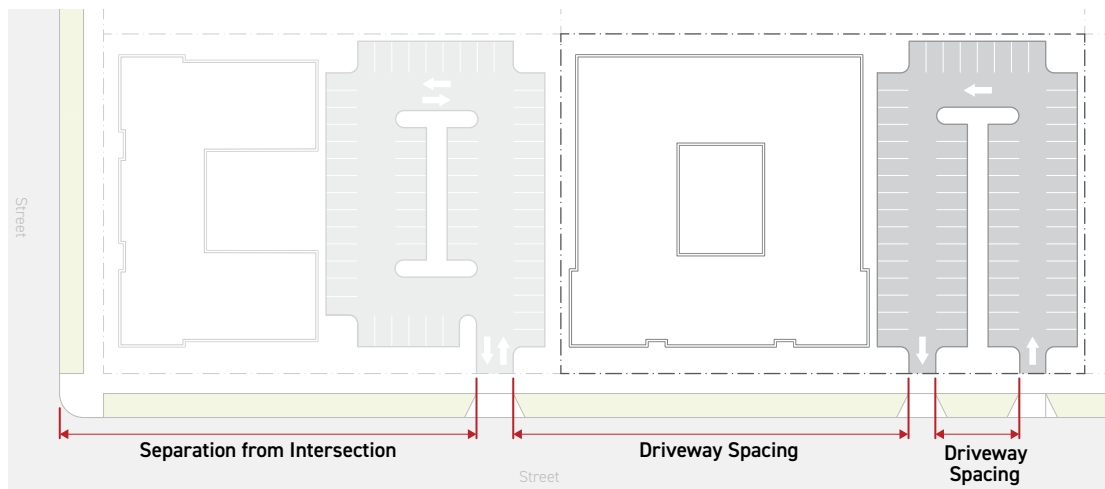

6. Access lane width is measured as the narrowest horizontal dimension from edge of access lane to edge of access lane for the full length of the access lane.
7. Access lane reservoir depth is measured from the applicable street lot line, into the lot and perpendicular to the driveway lane width, to the nearest parking stall, drive aisle or vehicle entry restriction device.

E. Relief

1. A deviation from any automobile access standard may be requested in accordance with *Sec. 13B.5.1. (Alternative Compliance)*.
2. A deviation from any driveway separation, width or depth dimensional standard, or driveway separation of up to 20% may be requested in accordance with *Sec. 13.B.5.2. (Adjustment)*.

3. One additional access lane in excess of the maximum number of access lanes permitted may be requested in accordance with *Sec. 13.B.5.2. (Adjustment)*.
4. A deviation from any automobile access standard may be allowed as a variance in accordance with *Sec. 13.B.5.3 (Variance)*.

SEC. 4C.2.2. **MOTOR VEHICLE USE AREA DESIGN**

A. **Intent**

To ensure motor vehicle use areas are designed in a manner that does not detract from the safety, comfort, or enjoyment of users of neighboring lots or the public realm.

B. **Applicability**

1. Motor vehicle use area design standards apply to portions of a lot designed and intended for use by motor vehicles, including areas to be used by motor vehicles for circulation, maneuvering, loading, staging, queuing, service areas and areas to be used for the sale or storage of motor vehicles.
2. Parking lots and parking structures are excluded from motor vehicle use area design standards. For parking lots and parking structure design standards see *Sec. 4C.4.4. (Parking Area Design)*.
3. Freight loading area standards apply to all freight loading areas on-site.
4. Loading space standards do not apply to change-of-use projects.
5. Drive-through standards apply to all proposed drive-through facilities.

C. **Standards**

1. **General**

a. **Location**

- i. Motor vehicle use areas shall not be located in a frontage yard.
- ii. Motor vehicle use areas shall not be located in the area between a frontage lot line and the minimum parking frontage setback specified by the applicable Frontage District.

b. **Screening**

- i. Where a motor vehicle use area faces a frontage lot line, common lot line or an alley lot line the entire length of the motor vehicle use area shall be screened.
 - a) A type *F2 frontage screen* (*Sec. 4C.8.1.C.2.b.*) or a type *F3 frontage screen* (*Sec. 4C.8.1.C.2.c.*) is required between the motor vehicle use area and frontage lot lines for any portion of the length of the motor vehicle use area that faces a frontage lot line.
 - b) A Type *T1 transition screen* (*Sec. 4C.8.2.C.3.a.*) is required between the motor vehicle use area and common lot lines for any portion of the length of the motor vehicle use area that faces a common lot line.

- c) A Type *T1 transition screen* (Sec. 4C.8.2.C.3.a.) is required between the motor vehicle use area and alley lot lines for any portion of the length of the motor vehicle use area that faces an alley lot line.
- ii. Screens may only be located in a frontage yard where they comply with frontage yard fences and wall standards in the applied *Frontage District (Part 3B)*.

c. Containment Perimeter

Motor vehicle use areas shall include a containment perimeter that obstructs motor vehicles from leaving the designated motor vehicle use area. The containment perimeter shall be providing using one or more of the following containment methods around the entire perimeter except for crossings and access points required for driveways, drive aisles, pedestrian accessways, pedestrian passageways:

- i. Continuous curbs of no less than 4 inches in height.
- ii. Permanent bollards, walls, raised planters, or a similar containment method having a height no less than 30 inches and having a clear width of no more than 66 inches.
- iii. A planting area meeting Sec. 4C.6.4.C.2 (*Planting Areas*) with no horizontal dimension less than 5 feet.

d. Surfacing

- i. All automobile parking areas shall be graded and drained to collect, retain and infiltrate surface water on-site by applying Low Impact Development practices and standards in accordance with Section 64.72. (*Stormwater Pollution Control Measures for Development Planning and Construction Activities*) of Chapter 6 (*Public Works and Property*) of the LAMC.
- ii. Motor vehicle use areas shall be surfaced with hard, durable asphaltic paving which has been mixed at a plant and is at least two inches thick after compaction, with portland cement paving at least three inches thick or with an alternative paving material described below.
- iii. Alternative paving materials include the following: porous asphalt, porous concrete, permeable interlocking concrete pavers, permeable pavers, decomposed granite, crushed rock, gravel, and restrained systems (a plastic or concrete grid system confined on all sides to restrict lateral movement, and filled with gravel or grass in the voids.)
- iv. Alternative paving materials are permitted for use in every motor vehicle use area, subject to the following standards:
 - a) Any product installed within areas designated by the Fire Department as a fire lane must be approved by the Fire Department.

- b) Permeable interlocking concrete pavers and permeable pavers shall have a minimum thickness of 80 mm (3.14 inches).
- c) If plantings are an element of the alternative paving material, the irrigation system shall not utilize potable water except for plant establishment.
- d) Products and underlying drainage material shall be installed per manufacturers' specifications. Sub-grade soils shall be compacted as required per the product installation specifications.
- e) Decomposed granite, crushed rock and gravel shall only be allowed for driveways and parking areas serving a maximum of two dwelling units.

2. Freight Loading Areas

Areas designated for the on-site loading and unloading of freight vehicles.

a. General

All freight loading area on-site shall meet the following standards:

- i. Shall meet *Sec. 4C.2.2.C.1. (General, Motor Vehicle Use Area Design)*.
- ii. Shall meet the following dimensional standards:

FREIGHT LOADING AREA DIMENSIONAL STANDARDS	
Area (min)	400 SF
Width (min)	10'
Depth (min)	20'
Clear height (min)	14'

- iii. Freight loading areas shall be located and designed so that vehicles do not occupy any portion of the public right-of-way when stationary during loading and unloading.
- iv. Loading and unloading activities are not permitted in public streets, with the exception of loading areas designated by the City.
- v. Loading and unloading activities may not encroach on or interfere with the use of sidewalks, driveways, drive aisles, automobile queueing spaces, or parking areas.
- vi. All freight loading areas provided shall include one permanent "NO IDLING" sign for every 400 square feet of freight loading area. Signs shall be at least 18 inches by 24 inches in dimension and installed to be facing and located within 10 feet of each freight loading area provided. When multiple signs are required to be facing the same freight loading area signs shall be spaced a minimum of 10 feet apart.

b. Required Freight Loading Areas

Lots that include a tenant space of 10,000 square feet or greater designated for a public & institutional use, general commercial use, heavy commercial use, light industrial use, or heavy industrial use, that abut an alley having a width of 15 feet or greater, and have an alley lot line 50 feet or wider, shall meet the following additional standards.

- i. No less than the required freight loading area meeting the following standards shall be provided on-site for any subject tenant space:

FREIGHT LOADING AREA TOTAL AREA	
Non-Residential Tenant Size	Area (Min)
< 10,000 SF	None required
10,000 - < 50,000 SF	400 SF
50,000 - < 100,000 SF	600 SF
100,000 - < 200,000 SF	800 SF
> 200,000 SF	+200 SF / each additional 200,000 SF over 200,000 SF

- ii. The total required freight loading area may be provided as a single consolidated loading area or as separated loading spaces that each meet the required minimum dimensions.
- iii. Each required freight loading area shall have direct access to an alley for a minimum width of 12 feet, measured along the alley lot line. Alley access for a freight loading area may be shared among multiple motor vehicle use areas and parking lots.

3. Drive-Through Facilities

Facilities that provide goods or services to drivers in vehicles. Drive-through facilities include drive-through lanes consisting of automobile queuing spaces.

- a. Where the applicable automobile access package specifies that drive-through facilities are not allowed, no drive-through facility may be provided on-site.
- b. Where the applicable Development Standards District specifies that drive-through facilities are allowed, drive-through facility may be provided on-site provided they meet the following standards:
 - i. Shall meet Sec. 4C.2.2.C.1. (General, Motor Vehicle Use Area Design).
 - ii. Shall provide a number of automobile queuing spaces sufficient to accommodate the number of automobiles anticipated to be during peak demand, to the satisfaction of LADOT.
 - iii. Shall not encroach on or interfere with the use of sidewalks, drive aisles, loading areas or parking areas.

- iv. Each queuing space in a drive-through lane shall be a minimum of 20 feet in length and 8 feet in width along straight segments of the drive-through lane. Drive-through lanes shall be a minimum of 12 feet in width along curved segments.

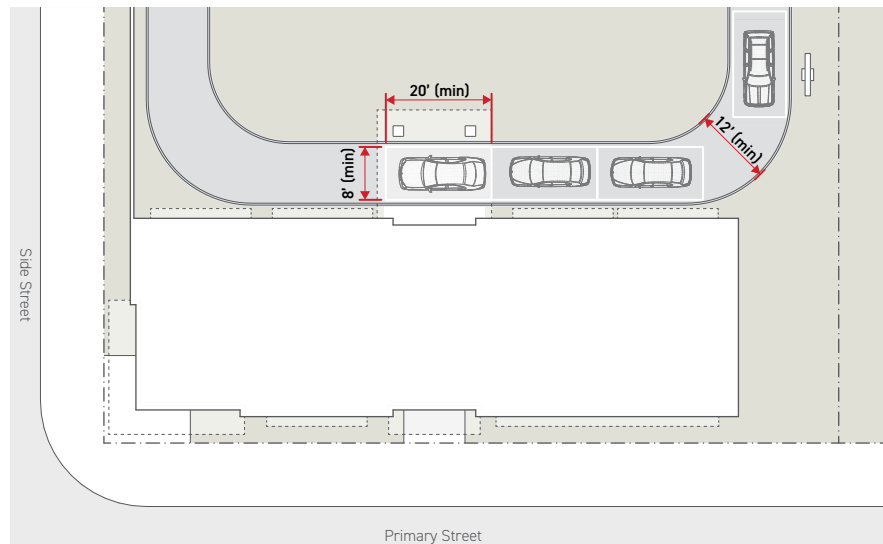

- v. Drive-through lanes that take access directly from the public right-of-way shall be regulated as a driveway and subject to the standards for driveways as specified by the automobile access package assigned by the applied Development Standards District (Part 4B) for the minimum required depth of the driveway reservoir.
- vi. All projects proposing drive-through lanes require additional review and approval by LADOT to ensure the site design does not create detrimental impacts on pedestrians bicyclists, transit vehicles or riders, micro mobility device users, and automobile traffic and circulation on the abutting right-of-way.

D. Measurement

1. For lot line determination see *Sec. 14.1.12 (Lot Line Determination)*.
2. For frontage yard designation see *Sec. 14.1.16.C.1. (Frontage yard)*.
3. For parking setback see *Sec. 3C.2.1. (Parking Setback)*.
4. Freight loading area width is measured as the narrowest horizontal distance between opposite edges of a designated freight loading area.
5. Freight loading area depth is measured as the narrowest horizontal distance measured perpendicular to the freight loading area width from one edge of a designated freight loading area to the opposite edge. A minimum freight loading area depth shall be met for all portions of the freight loading area width.
6. Freight loading area provided area is measured as the total area of all areas designated as freight loading area that meet all applicable requirements of *Sec. 4C.2.2.C.2. (Freight Loading Areas)*.

7. Drive-through queuing space depth is measured parallel to the drive-through lane from one end to the opposite end of the queuing space.
8. Drive-through queuing space width is measured perpendicular to the queuing space length from one end to the opposite end of the queuing space.

E. Relief

1. A deviation from any motor vehicle use area design dimensional standard of up to 10% may be requested in accordance with *Sec. 13B.5.2 (Adjustment)*.
2. A deviation from any motor vehicle use area design standard may be allowed as a variance in accordance with *Sec. 13B.5.3 (Variance)*.

DIV. 4C.3. BICYCLE PARKING

SEC. 4C.3.1. BICYCLE PARKING SPACES

A. Intent

To promote bicycling as an alternative to automobile transportation, ensure safe, secure, accessible, and convenient storage of bicycles for all users.

B. Applicability

1. Bicycle parking spaces standards apply to all buildings, structures and all portions of a lot.
2. Adaptive reuse projects in accordance with *Sec. 9.4.5. (Downtown Adaptive Reuse Projects)* and *Sec. 9.4.6. (Downtown Adaptive Reuse Projects)* are not required to provide additional bicycle parking.

C. Standards

The required number of short-term and long-term bicycle parking spaces are determined by use according to the following provisions:

1. Residential

For all residential uses containing more than 3 dwelling units, long-term and short-term bicycle parking shall be provided according to the ratios specified for each marginal increment of dwelling units as specified in the table below.

REQUIRED BICYCLE PARKING		
	SHORT-TERM <i>(Sec. 4C.3.2.)</i>	LONG-TERM <i>(Sec. 4C.3.3.)</i>
RESIDENTIAL		
1st 25 dwelling units	1/10 du, (2 min)	1/du
26th-100th dwelling unit	1/15 du, (2 min)	1/1.5 du
101st-200th dwelling unit	1/20 du, (2 min)	1/2 du
201st + dwelling units	1/40 du, (2 min)	1/4 du

- a. Developments that include individually accessed private garages for each unit shall not be required to provide long-term bicycle parking.
- b. For all medical care and non-medical supportive housing, short-term bicycle parking shall be provided at a rate of 1 space per 10,000 square feet of floor area and long-term bicycle parking shall be provided at a rate of 1 space per 5,000 square feet of floor area. A minimum of 2 short-term and 2 long-term bicycle parking spaces shall be provided.

2. Public and Institutional, Open Space & Recreation, Transportation, General Commercial, Heavy Commercial, and Industrial Uses

Short-term and long-term bicycle parking shall be provided for all public and institutional uses, transportation uses, commercial uses, and industrial uses as specified below, with the exception of *unmanned facilities (Sec. 4C.3.1.C.2.f)*. After the first 100 bicycle parking spaces are provided, additional spaces may be provided at the minimum number required by the *California Green Building Standards Code Section 5.106.4*.

REQUIRED BICYCLE PARKING		
	SHORT-TERM (Sec. 4C.3.2.)	LONG-TERM (Sec. 4C.3.3.)
PUBLIC & INSTITUTIONAL		
Public and Institutional Uses, except as listed below:	1/10,000 SF, (2 min)	1/5,000 SF, (2 min)
Civic: All	1/10 provided automobile parking stalls, (5 min)	1/10 required automobile parking stalls, (5 min)
School, K-12	4/classroom, (2 min)	1/10 classrooms, (2 min)
School, Postsecondary	1/500 SF or 1/50 fixed seats whichever is greater, (2 min)	1/1,000 SF or 1/100 fixed seats whichever is greater, (2 min)
Utilities: All	--	--
OPEN SPACE & RECREATION		
Open space & Recreation, except as listed below:	1/10,000 SF, (2 min)	1/10,000 SF, (2 min)
Nature Reserve	--	--
Open Space, Public	1/10 provided automobile parking stalls, (5 min)	1/10 provided automobile parking stalls, (5 min)
Open Space, Public (< 2 acres and no automobile parking provided)	--	--
Recreation, Public	1/10 provided automobile parking stalls, (5 min)	1/10 provided automobile parking stalls, (5 min)
TRANSPORTATION		
All	--	--
COMMERCIAL		
All Commercial Uses, except as listed below:	1/10,000 SF, (2 min)	1/10,000 SF, (2 min)
Eating & Drinking: All	1/2,000 SF, (2 min)	1/2,000 SF, (2 min)
Entertainment Venue: All	1/350 SF or 1/50 fixed seats whichever is greater, (2 min)	1/700 SF or 1/100 fixed seats whichever is greater, (2 min)
Lodging (containing more than 5 lodging rooms)	1/10 Lodging Rooms, (2 min)	1/10 Lodging Rooms, (2 min)
Office	1/10,000 SF, (2 min)	1/5,000 SF, (2 min)
Retail, except as listed below:	1/2,000 SF, (2 min)	1/2,000 SF, (2 min)
Furniture or Major Appliance	1/10,000 SF, (2 min)	1/10,000 SF, (2 min)
HEAVY COMMERCIAL		
All Heavy Commercial Uses, except as listed below:	1/10,000 SF, (2 min)	1/10,000 SF, (2 min)
Storage: All	--	--
LIGHT & HEAVY INDUSTRIAL		
All	1/10,000 SF, (2 min)	1/10,000 SF, (2 min)

3. City Operated Uses

In all buildings or parking lots used by the City of Los Angeles for government purposes, including government office buildings, both short-term and long-term bicycle parking shall be provided at a rate of 10% of the required parking available on the site. However, no less than 5 short-term bicycle spaces and no less than 5 long-term bicycle parking shall be provided for the lot.

D. Measurement

1. Multiple Uses

Where there is a combination of uses on a lot, the number of bicycle parking spaces required is the sum of the requirements of the various uses. The exceptions provided in *Sec. 4C.4.1.E.* for automobile parking also apply to bicycle parking.

2. Fractions

When the application of these regulations results in the requirement of a fractional bicycle space, any fraction up to and including one-half may be disregarded, and any fraction over one-half is construed as requiring one bicycle parking space. Rounding shall occur after taking the sum of bicycle parking required across all proposed uses, and shall be calculated separately for long-term and short-term spaces.

E. Exceptions

1. Unmanned Facilities

No bicycle parking is required for unmanned facilities, such as stand-alone public restrooms in parks or unmanned cellular antenna facilities.

F. Relief

1. A deviation from any required bicycle parking dimensional standard of up to 10% may be requested in accordance with *Sec. 13B.5.2 (Adjustment)*.
2. A deviation from any required bicycle parking standard may be allowed as a variance in accordance with *Sec. 13B.5.3 (Variance)*.

SEC. 4C.3.2. **SHORT-TERM BICYCLE PARKING DESIGN**

A. **Intent**

To promote bicycling as an alternative to automobile transportation, ensure safe, secure, accessible, and convenient storage of bicycles for visitors and other short-term users, improve bicyclist access from the public realm to the interior of buildings, and ensure entrances are conveniently and effectively accessible to bicyclists.

B. **Applicability**

Short-term bicycle parking design standards apply to all short-term bicycle parking spaces required by *Sec. 4C.3.1 (Required Bicycle Parking)*.

C. **Standards**

1. **General**

- a. Adequate lighting shall be provided to ensure safe access to bicycle parking facilities in accordance with *Sec. 4C.10.1 (Outdoor Lighting)*.
- b. No rules that unreasonably interfere with the ability of bicyclists to safely and conveniently access bicycle parking are allowed. Unreasonable rules include shorter operating hours for short-term bicycle parking than for any building or automobile parking, prohibitions on walking of bicycles in pedestrian areas that provide access to bicycle parking, and prohibitions on bicycles in elevators where elevators are used to provide access to bicycle parking. The provisions of this Section do not prohibit property owners from requiring bicycles to be walked in pedestrian-only areas.

2. **Bicycle Parking Space Design**

a. **General**

- i. Required short-term bicycle parking shall consist of bicycle racks that support the bicycle frame at two points. Racks that support only the wheel of the bicycle are not permissible.
- ii. Racks shall allow for the bicycle frame and at least 1 wheel to be locked to the racks.
- iii. The bicycle rack shall allow for the use of a cable as well as a U-shaped lock.
- iv. If bicycles can be locked to each side of the rack, each side can be counted toward a required space.
- v. Racks shall be securely anchored to a permanent surface.
- vi. If more than 20 short-term bicycle parking spaces are provided, at least 50% of the bicycle parking spaces shall be 100% covered by a roof or overhang.

- Bicycle Parking -

- vii. Bicycle share station docks counted toward the requirements for short-term bicycle parking spaces as permitted in *Sec. 4C.3.2.C.3. (Siting Requirements)* shall conform to *Sec. 4C.3.2.C.6. (Bicycle Share Station)*.

b. Horizontal Storage

- i. Short-term bicycle parking spaces shall be a minimum of 2 feet wide and 6 feet long.
- ii. Individual racks installed beside each other that allow bicycles to be locked to either side of the rack shall be spaced a minimum of 30 inches on center.
- iii. Racks installed parallel to walls shall be a minimum of 30 inches from the wall, except that bicycle parking spaces providing a tray or channel for insertion of bicycle wheels shall be placed a minimum of 20 inches from the wall.
- iv. Bicycle parking spaces arranged in a vertically staggered layout that permits bicycles to be placed in and removed from each individual space without interference from bicycles in adjoining spaces shall be spaced a minimum of 16 inches on center.

c. Stacked Storage

- i. Short-term bicycle parking may be mounted so that bicycles are stored in a stacked, two-tier layout, provided such parking is an attended bicycle facility where facility staff parks the bicycles, or such racks provide mechanical assistance for lifting the bicycle. If stacked bicycle storage is provided as an attended bicycle service, the service must meet the standards outlined in *Sec. 4C.3.2.C.7. (Attended Bicycle Parking Service)*.
- ii. Racks installed parallel to walls shall be a minimum of 14 inches from the wall if such spaces are on the upper level of a stacked, two-tier rack.

3. Siting Requirements

- a. Required short-term bicycle parking shall be provided in one of the following locations:
 - i. On the same lot as the use for which it is intended to serve.
 - ii. In a parking facility serving that use.
 - iii. Immediately in front of a lot within the public right-of-way in accordance with *Sec. 4C.3.2.C.4 (Bicycle Parking in the Public Right-of-Way)*.
 - iv. In a city-funded bicycle corral in accordance with *Sec. 4C.3.2.C.5 (Bicycle Corrals)*.
 - v. In a bicycle share station in accordance with *Sec. 4C.3.2.C.6 (Bicycle Share Stations)*.
- b. Bicycle parking shall be located so as to allow bicyclists safe and convenient access to and from the site.
- c. Bicyclists shall not be required to rely on stairways or escalators for access or to share access with automobiles or other motor vehicles.

- d. Elevators providing access for bicyclists shall be sized to accommodate standard adult bicycle dimensions with both wheels on the floor (at least 6 feet by 2 feet).
- e. Short-term bicycle parking shall be located so as to provide safe and convenient access to visitors.
- f. For new construction, at least 50% of short-term bicycle parking shall be located outside buildings or parking structures; however, no more than 8 short-term bicycle parking spaces per 100 linear feet of street frontage are required to be outside.
- g. All short-term bicycle parking spaces located inside the building or parking structure shall be located on the ground story with a direct pedestrian accessway to a public street.
- h. For new construction, addition, site alteration or major renovation, short-term bicycle parking shall be located to maximize visibility from a pedestrian entrance.
- i. All short-term bicycle parking areas located within buildings or parking garages require signs meeting the following standards:
 - i. Permanently posted at the street entrance to each site.
 - ii. Legible and reflectorized.
 - iii. Indicate the availability and location of bicycle parking within the site.
 - iv. All signs shall comply with *Div. 4C.12 (Signs)*.
- j. Short-term bicycle parking spaces may be located no farther than 100 feet of walking distance from a pedestrian entrance that provides access to uses that require the bicycle parking spaces.
- k. For buildings with more than one pedestrian entrance, short-term bicycle parking, with the exception of bicycle share stations, shall be distributed in approximately equal proportions among all pedestrian entrances. In buildings with 3 or more pedestrian entrances, no more than 50% of all short-term bicycle parking spaces shall be assigned to a single pedestrian entrance.

4. **Bicycle Parking in the Public Right-of-Way**

- a. Business operators or property owners may install their own racks within the public right-of-way unless a City owned rack already exists.
- b. Business operators or property owners are responsible for applying for a permit with the Bureau of Engineering to install short-term bicycle parking within the public right-of-way. A Bureau of Engineering permit may be issued only after the business operator or property owner receives issuance of plan approval or a permit by LADOT pursuant to *LAMC Section 85.04 (Bicycle Infrastructure Zones)*.

- Bicycle Parking -

- c. All bicycle parking provided in the public right-of-way shall meet the rules and regulations set out by the *Bureau of Engineering Standard Plan S-671*.
- d. Business operators or property owners who choose to install bicycle parking within the public right-of-way are responsible for maintaining the racks according to the standards set forth in a Covenant Maintenance Agreement with LADOT.

5. Bicycle Corrals**a. City-Funded Bicycle Corrals**

Any site located within 500 feet of a City-funded bicycle corral may count up to 4 bicycle parking spaces within the bicycle corral towards their required short-term bicycle parking spaces.

b. Bicycle Corral Parking Incentive Program

- i. Business operators or property owners may submit an application to LADOT to install and maintain their own bicycle corrals immediately in front of their property in the public right-of-way.
- ii. Businesses or property owners who do so may count all the bicycle parking within the bicycle corral toward their required number of short-term bicycle parking spaces. In such cases, short-term bicycle parking installed in such a manner cannot be counted towards the bicycle parking requirements of surrounding businesses.
- iii. Business operators or property owners shall pay the construction and maintenance costs of building said bicycle corrals.
- iv. Multiple businesses or property owners may submit an application to LADOT as a group and split the costs to construct and maintain the corral.
 - a) In such cases, a single property owner is responsible for assuming the maintenance responsibilities detailed in a Covenant Maintenance Agreement as outlined below.
 - b) The property owner named in the covenant who is responsible for maintaining the bicycle corral may count the full amount of bicycle parking in the corral towards its short-term bicycle parking requirements.
 - c) All other businesses may count up to half of the bicycle parking spaces in the corral towards their required short-term bicycle parking spaces so long as they provide a financial contribution.
- v. Business operators or property owners are responsible for applying for a permit with the Bureau of Engineering to install bicycle corrals within the public right-of-way.

- vi. Business operators or property owners who choose to install bicycle corrals within the public right-of-way are responsible for maintaining the racks according to the standards set forth in a Covenant Maintenance Agreement with LADOT.
- vii. If, for any reason, the responsibility for maintaining a bicycle corral is returned to the City of Los Angeles, it will be considered a City-funded bicycle corral.
- viii. If, for any reason, the City determines that a bicycle corral must be removed, business owners shall no longer be able to count the spaces removed toward their required bicycle parking. In such cases, said businesses shall be required to provide any bicycle parking spaces lost in the removal of the bicycle corral. Failure to comply may result in the revocation of a business's certificate of occupancy and a fine for code violation.

6. Bicycle Share Stations

- a. Bicycle share stations shall conform to *Sec. 4C.3.2.C.3. (Siting Requirements)*.
- b. Business operators or property owners may allow a bicycle share service provider to install one or more bicycle share stations on their property, provided that such bicycle share station is part of a bicycle share system approved by LADOT and complies with all location criteria established by LADOT for bicycle share stations.
- c. Any site within 500 feet of a bicycle share station may count up to 4 bicycle share docks toward the required number of short-term bicycle parking spaces for a building or buildings on the same lot. In all cases, the number of bicycle share docks counted toward the required number of short-term bicycle parking spaces cannot exceed 10% of the total number of short-term bicycle parking spaces required for the subject site.
- d. Where bicycle share docks are counted toward the required number of short-term bicycle parking spaces, residential and nonresidential uses may replace a percentage of the required automobile parking spaces with bicycle share docks in a manner consistent with the limitations and replacement ratio established in *Sec. 4C.4.1.C.4. (Substituting Required Automobile Parking with Bicycle Parking)*.
- e. If, for any reason, bicycle share docks are removed, the associated land uses may no longer count the docks removed toward required bicycle parking and shall be required to replace the number of docks formerly counted toward required bicycle parking with an equivalent number of bicycle parking spaces.

7. Attended Bicycle Parking Service

- a. Pick-up and drop-off location shall either comply with *Sec. 4C.3.3.C.3. (Siting Requirements)* or be co-located with a valet automobile parking pick-up or drop-off location provided on the same site for the subject use.
- b. If some or all required short-term bicycle parking spaces are provided by means of an attended bicycle parking service, the service shall be available to building occupants at all times during the hours the building is in operation.

- Bicycle Parking -

- c. If, for any reason, an attended bicycle parking service is discontinued, the associated land uses may no longer count the attended bicycle parking service toward their required number of bicycle parking spaces and shall be required to provide a number of bicycle parking spaces equivalent to the number formerly provided by the attended bicycle parking service.

D. Measurement

[Reserved]

E. Relief

1. An alternative to any short-term bicycle parking design standards may be requested in accordance with *Sec. 13B.5.1 (Alternative Compliance)*.
2. A deviation from any short-term bicycle parking design dimensional standard of up to 10% may be requested in accordance with *Sec. 13B.5.2 (Adjustment)*.
3. A deviation from any short-term bicycle parking design standard may be allowed as a variance in accordance with *Sec. 13B.5.3 (Variance)*.

SEC. 4C.3.3. **LONG-TERM BICYCLE PARKING DESIGN**

A. **Intent**

To promote bicycling as an alternative to automobile transportation, ensure safe, secure, accessible, and convenient storage of bicycles for tenants and other long-term users, improve bicyclist access from the public realm to the interior of buildings, and ensure entrances are conveniently and effectively accessible to bicyclists.

B. **Applicability**

Long-term bicycle parking design standards apply to all long-term bicycle parking spaces required by *Sec. 4C.3.1 (Required Bicycle Parking Spaces)*.

C. **Standards**

1. **General**

- a. Adequate lighting shall be provided to ensure safe access to bicycle parking facilities in accordance with *Sec. 4C.10.1 (Outdoor Lighting)*.
- b. No rules that unreasonably interfere with the ability of bicyclists to safely and conveniently access bicycle parking are allowed. Unreasonable rules include shorter operating hours for long-term bicycle parking than for any building or automobile parking, prohibitions on walking of bicycles in pedestrian areas that provide access to bicycle parking, and prohibitions on bicycles in elevators where elevators are used to provide access to bicycle parking. The provisions of this Section do not prohibit property owners from requiring bicycles to be walked in pedestrian-only areas.

2. **Bicycle Parking Space Design**

a. **General**

- i. Long-term bicycle parking shall be secured from the general public and protected from inclement weather. All long-term bicycle parking shall be 100% enclosed and 100% covered.
- ii. Acceptable examples of long-term bicycle parking include bicycle lockers, bicycle rooms, bicycle cages, or commercially operated attended bicycle facilities.
- iii. Except in the case of lockers and commercially operated attended bicycle parking, all long-term bicycle parking shall provide a means of securing the bicycle frame at two points to a securely anchored rack.

b. **Horizontal Storage**

Long-term bicycle parking spaces shall be sized to permit safe, efficient, and convenient access to each individual bicycle parking space without interference from bicycles in adjoining spaces, as described below:

- Bicycle Parking -

- i. Individual racks installed beside each other within bicycle rooms or bicycle cages that allow bicycles to be locked to either side of the rack shall be spaced a minimum of 30 inches on center.
- ii. Racks installed parallel to walls shall be a minimum of 30 inches from the wall, with the exception that bicycle parking spaces that provide a tray into which the bicycle wheels may be inserted may be placed a minimum of 20 inches from the wall, or 14 inches from the wall if such spaces are on the upper level of a stacked, two-tier rack.
- iii. Triangular lockers with varying widths may be used so long as the opening is at least 2 feet wide.
- iv. Bicycle parking spaces arranged in a vertically staggered layout that permits bicycles to be placed in and removed from each individual space without interference from bicycles in adjoining spaces may be spaced a minimum of 16 inches on center.
- v. If more than 20 long-term bicycle parking spaces are provided, a workspace of 100 square feet shall be provided adjacent to the long-term bicycle parking to allow bicyclists to maintain their bicycles. However, where long-term bicycle parking is provided in more than one location, a single workspace may be provided adjacent to the location with the greatest number of long-term bicycle parking spaces.

c. Vertical Storage

Long-term bicycle parking may be mounted so that the bicycle is stored vertically. Such devices that hold the bicycle by the wheel shall be designed to support the bicycle without damaging the wheels. Vertically installed bicycle parking shall be a minimum of 4 feet deep and 6 feet in height.

d. Stacked Storage

Long-term or short-term bicycle parking may be mounted so that bicycles are stored in a stacked, two-tier layout, provided such parking is an attended bicycle facility where facility staff parks the bicycles, or such racks provide mechanical assistance for lifting the bicycle.

3. Siting Requirements

- a. Long-term bicycle parking spaces shall be provided in one of the following locations, or in a combination of the following locations:
 - i. On the ground story within 100 feet of the major entrance to the lobby. There shall be safe and convenient access between the public right-of-way, the bicycle parking space, and the lobby area.
 - ii. In the off-street automobile parking area, subject to the following limitations:

- a) Long-term bicycle parking inside a parking garage may be no more than 200 feet from a pedestrian entrance to the main building, and located so as to provide reasonably convenient access from the bicycle parking to the nearest walkway, ramp, or elevator providing access to the building.
 - b) Long-term bicycle parking inside a parking garage shall be located within the space available on the building's pedestrian entry level, after required handicapped-accessible parking stalls and other required elements have been provided. Remaining long-term bicycle parking may be provided on other levels of the parking garage in accordance with the provisions of *Sec 4C.3.3.C.3. (Siting Requirements)*.
 - iii. One level above or below the ground story, within 100 feet of the elevator, ramp, walkway, or other building entrance on that story. In such cases, elevator or ramp access to the building shall be provided.
 - iv. Residential long-term bicycle parking may be provided in common storage facilities on residential floors in accordance with *Sec. 4C.3.3.C.2. (Bicycle Parking Space Design)*. If residential long-term bicycle parking is provided on residential floors, the amount of bicycle parking on each floor shall be equal to or greater than 50% of the number of dwelling units on the same floor.
 - b. For lots with multiple uses, long-term bicycle parking may be provided in one or more bicycle parking facilities within 200 feet of each use.
 - c. For lots with multiple buildings, required bicycle parking may be sited in one or more bicycle parking facilities within 200 feet of each building.
 - d. Bicycle parking shall be located so as to allow bicyclists safe and convenient access to and from the site.
 - e. Bicyclists shall not be required to rely on stairways or escalators for access or to share access with automobiles or other motor vehicles.
 - f. Elevators providing access for bicyclists shall be sized to accommodate standard adult bicycle dimensions with both wheels on the floor (at least 6 feet by 2 feet).
4. **Showers and Personal Lockers**

Showers and personal lockers are required for long-term bicycle parking in nonresidential uses in accordance with *LAMC Section 91.6307 (Shower and Locker Facilities)*. If showers and personal lockers are provided, such showers and personal lockers shall remain available for the use of building occupants, including residents or employees, arriving by bicycle.

5. **Attended Bicycle Parking Service**

- a. Pick-up and drop-off location shall either comply with *Sec. 4C.3.3.C.3. (Siting Requirements)* or be co-located with a valet automobile parking pick-up or drop-off location provided on the same site for the subject use.
- b. If some or all required bicycle parking spaces are provided by means of an attended bicycle parking service, the service shall be available to building occupants at all times during the hours the building is in operation.
- c. If, for any reason, an attended bicycle parking service is discontinued, the associated land uses may no longer count the attended bicycle parking service toward the required number of bicycle parking spaces and shall provide a number of bicycle parking spaces equivalent to the number formerly provided by the attended bicycle parking service.

D. **Measurement**

[Reserved]

E. **Relief**

1. An alternative to any long-term bicycle parking design standards may be requested in accordance with *Sec. 13B.5.1 (Alternative Compliance)*.
2. A deviation from any long-term bicycle parking design dimensional standard of up to 10% may be requested in accordance with *Sec. 13B.5.2 (Adjustment)*.
3. A deviation from any long-term bicycle parking design standard may be allowed as a variance in accordance with *Sec. 13B.5.3 (Variance)*.

DIV. 4C.4. **AUTOMOBILE PARKING**

SEC. 4C.4.1. **AUTOMOBILE PARKING STALLS**

Space within a building, or a private or public parking area, exclusive of driveways, ramps, columns, office, and work areas, for the parking of one automobile. Does not include bicycle parking.

A. **Intent**

To accommodate the arrival to a site by automobile at a level appropriate to the demand generated by a particular use within different mobility contexts without creating detrimental effects on surrounding properties or public right-of-way.

B. **Applicability**

Required automobile parking stall standards apply to all uses on a lot determined by the automobile parking package assigned by the applicable Development Standards District.

C. **Standards**

1. **General**

- a. All uses subject to the parking requirements of Division 4C.4. (Automobile Parking) shall provide the minimum number of automobile parking stalls specified in the parking package assigned by the applied *Development Standards District (Part 4C)*.
- b. When a site or lot is used for a combination of uses, the parking requirements are the sum of the requirements for each use, and no parking stall for one use may be included in the calculation of parking requirements for any other use, with the following exceptions:
 - i. As allowed in Sec. 4C.4.3.C.2 (Shared Parking).
 - ii. When parking requirements for a single use on a site or lot with a combination of uses results in a fraction, then the total parking required for all uses on a site or lot shall be calculated based on the sum prior to the rounding of parking requirements for each use followed by rounding the total amount of parking required for a site or lot based on the combination of uses.
- c. For electric vehicle charging space requirements, see the *LAMC Chapter 9, Article 9 (Green Building Code)*.

2. **Required Automobile Parking Table**

- a. When the Required Automobile Parking Table lists multiple parking stall requirement options, the option that results in the greater number of required parking stalls applies.
- b. Uses are defined in *Part 5C.1. (Use Definitions)*.

- Automobile Parking -

-TABLE 1- REQUIRED AUTOMOBILE PARKING

	PARKING PACKAGE				
	A	B	C	D	E
RESIDENTIAL					
Dwelling:					
Dwelling Units:					
1-4 Habitable Rooms	--	0.25/du	0.5/du	0.75/du	1/du
5+ Habitable Rooms	--	0.75/du	1/du	1.5/du	2/du
Accessory Dwelling Unit	See Div 9.5. (Accessory Dwelling Unit Incentive Program)				
Household Business:					
Family Child Care	See Dwelling (No additional parking required beyond Dwelling)				
Home Occupation	See Dwelling (No additional parking required beyond Dwelling)				
Home Sharing	See Dwelling (No additional parking required beyond Dwelling)				
Joint Live/Work Quarters	Entire Unit including workspace treated as Dwelling Unit				
Live Work	Entire Unit including workspace treated as Dwelling Unit				
Mobilehome Park	See Title 25 of the California Administrative Code				
Supportive Housing:					
Medical Care	--	0.05/bed	0.1/bed	0.15/bed	0.2/bed
Non-Medical	--	0.25/du	0.5/du	0.75/du	1/du
Permenant Supportive Housing	--	0.05/du	0.1/du	0.15/du	0.2/du
Transitional Shelter	--	--	--	--	--
Homeless Shelter	--	--	--	2/shelter	2/shelter
PUBLIC AND INSTITUTIONAL					
Cemetery	--	--	--	--	--
Civic Facility	--	0.5/1,000 SF	1/1,000 SF	1.5/1,000 SF	2/1,000 SF
Detention	--	--	--	--	--
Fleet Services	--	--	--	--	--
Medical					
Local	--	0.1/bed	0.1/bed	0.2/bed	0.2/bed
Regional	--	0.5/bed	1/bed	1.5/bed	2/bed
Office, Government	--	0.5/1,000 SF	1/1,000 SF	1.5/1,000 SF	2/1,000 SF
Parking	--	--	--	--	--
Religious Assembly, excluding all non assembly area	--	10/1,000 SF	15/1,000 SF	20/1,000 SF	25/1,000 SF
School:					
Preschool/Daycare	--	0.25/1,000 SF	0.5/1,000 SF	0.75/1,000 SF	1/1,000 SF
K-12	--	0.25/1,000 SF	0.5/1,000 SF	0.75/1,000 SF	1/1,000 SF
Post-secondary	--	0.5/1,000 SF	1/1,000 SF	1.5/1,000 SF	2/1,000 SF
Social Services	--	0.5/1,000 SF	1/1,000 SF	1.5/1,000 SF	2/1,000 SF

"--" = no parking required, "du" = dwelling unit, "SF" = square feet, "ac" = acre.

-TABLE 1- REQUIRED AUTOMOBILE PARKING

	PARKING PACKAGE				
	A	B	C	D	E
Utilities	--	--	--	--	--
OPEN SPACE & RECREATION					
Indoor Recreation, Commercial	--	0.5/1,000 SF	1/1,000 SF	1.5/1,000 SF	2/1,000 SF
Nature Reserve	--	--	--	--	--
Open Space, Public	--	--	--	--	--
Outdoor Recreation, Commercial	--	--	--	--	--
Recreation, Public	--	--	--	--	--
Sports Arena and Stadium, Major, excluding all non assembly area	--	10/1,000 SF	15/1,000 SF	20/1,000 SF	25/1,000 SF
TRANSPORTATION USES					
All	--	--	--	--	--
GENERAL COMMERCIAL					
Animal Sales and Services:					
Kennel		0.5/1,000 SF	1/1,000 SF	1.5/1,000 SF	2/1,000 SF
Veterinary Care	--	0.5/1,000 SF	1/1,000 SF	1.5/1,000 SF	2/1,000 SF
Commissary Kitchen	--	0.5/1,000 SF	1/1,000 SF	1.5/1,000 SF	2/1,000 SF
Eating and Drinking:					
Service floor area	--	1/1,000 SF	2/1,000 SF	4/1,000 SF	5/1,000 SF
Food & drink preparation area	--	0.5/1,000 SF	1/1,000 SF	1.5/1,000 SF	2/1,000 SF
Entertainment Venue, excluding all non assembly area	--	10/1,000 SF	15/1,000 SF	20/1,000 SF	25/1,000 SF
Financial Services	--	0.5/1,000 SF	1/1,000 SF	1.5/1,000 SF	2/1,000 SF
Instructional Services	--	0.5/1,000 SF	1/1,000 SF	1.5/1,000 SF	2/1,000 SF
Lodging:					
First 30 rooms	--	0.5/lodging unit	0.5/lodging unit	1/lodging unit	1/lodging unit
Next 30 rooms	--	0.25/lodging unit	0.25/lodging unit	0.5/lodging unit	0.5/lodging unit
Remaining rooms	--	--	--	0.25/lodging unit	0.25/lodging unit
Medical Clinic	--	0.5/1,000 SF	1/1,000 SF	1.5/1,000 SF	2/1,000 SF
Office	--	0.5/1,000 SF	1/1,000 SF	1.5/1,000 SF	2/1,000 SF
Personal Services	--	0.5/1,000 SF	1/1,000 SF	1.5/1,000 SF	2/1,000 SF
Postmortem Services	--	0.5/1,000 SF	1/1,000 SF	1.5/1,000 SF	2/1,000 SF
Retail Sales:					
Sales floor area	--	1/1,000 SF	2/1,000 SF	3/1,000 SF	4/1,000 SF
Showroom area	--	0.5/1,000 SF	1/1,000 SF	1.5/1,000 SF	2/1,000 SF
Sexually Oriented Business	--	1/1,000 SF	2/1,000 SF	3/1,000 SF	4/1,000 SF

"--" = no parking required, "du" = dwelling unit, "SF" = square feet, "ac" = acre.

-TABLE 1- REQUIRED AUTOMOBILE PARKING

	PARKING PACKAGE				
	A	B	C	D	E
HEAVY COMMERCIAL USES					
Motor Vehicle Services, except as listed below:	--	0.5/1,000 SF	1/1,000 SF	1.5/1,000 SF	2/1,000 SF
Car Wash	--	--	--	--	--
Motor Vehicle Sales and Rental	--	0.5/1,000 SF	1/1,000 SF	1.5/1,000 SF	2/1,000 SF
Storage, Indoor		0.5/1,000 SF (1st 10,000 SF) + 0.1/1,000 SF after	1/1,000 SF (1st 10,000 SF) + 0.1/1,000 SF after	1.5/1,000 SF (1st 10,000 SF) + 0.2/1,000 SF after	2/1,000 SF (1st 10,000 SF) + 0.2/1,000 SF after
Storage, Outdoor:					
0-1 acre of outdoor storage area	--	2	3	5	6
>1-2 acres of outdoor storage area	--	1/ac	1.5/ac	2.5/ac	3.5/ac
>2 acres of outdoor storage area	--	0.25/ac	0.5/ac	0.75/ac	1/ac
LIGHT INDUSTRIAL USES					
All Light Industrial	--	0.5/1,000 SF (1st 10,000 SF) + 0.1/1,000 SF after	1/1,000 SF (1st 10,000 SF) + 0.1/1,000 SF after	1.5/1,000 SF (1st 10,000 SF) + 0.2/1,000 SF after	2/1,000 SF (1st 10,000 SF) + 0.2/1,000 SF after
HEAVY INDUSTRIAL USES					
All Heavy Industrial, except as listed below	--	0.5/1,000 SF (1st 10,000 SF) + 0.1/1,000 SF after	1/1,000 SF (1st 10,000 SF) + 0.1/1,000 SF after	1.5/1,000 SF (1st 10,000 SF) + 0.2/1,000 SF after	2/1,000 SF (1st 10,000 SF) + 0.2/1,000 SF after
Salvage Yard:					
0-1 acre of outdoor storage area	--	2	3	5	6
>1-2 acres of outdoor storage area	--	1/ac	1.5/ac	2.5/ac	3.5/ac
>2 acres of outdoor storage area	--	0.25/ac	0.5/ac	0.75/ac	1/ac
AGRICULTURAL USES					
All Agriculture	--	--	--	--	--

"--" = no parking required, "du" = dwelling unit, "SF" = square feet, "ac" = acre.

D. Measurement

1. Parking Stalls Per 1,000 Square Feet

When determining parking stall requirements specified as a ratio having a denominator of "1,000 SF" the method for determining the total number of required parking stalls shall be executed as follows:

- a. Divide the total floor area of the subject use by 1,000. For determining floor area of the specified use, see 4C.4.1.D.2. (Square Feet).

- b. Multiply the result by the numerator in the specified parking ratio. If the result is a fraction, round in accordance with 4C.4.1.D.3. (*Fractional Spaces*).
- c. The result shall be the total number of required parking stalls.

2. **Parking Stalls Per Acre**

When determining parking stall requirements specified as a ratio having a denominator of "acre" the method for determining the total number of required parking stalls shall be executed as follows:

- a. Divide the total area of the subject use by 43,560. For determining floor area of the specified use, see 4C.4.1.D.2. (*Square Feet*).
- b. Multiply the result by the numerator in the specified parking ratio. If the result is a fraction, round in accordance with 4C.4.1.D.3. (*Fractional Spaces*).
- c. The result shall be the total number of required parking stalls.

3. **Square Feet**

For the purpose of calculating required parking stalls in Sec. 4C.4.1. (*Automobile Parking Stalls*), square feet refers to the total on-site floor area dedicated to a subject use, measured in square feet. The total floor area includes the floor area of accessory buildings. For the calculation of floor area, see Sec. 14.1.7. (*Floor Area*).

4. **Habitable Rooms**

For the purpose of applying the automobile parking space requirements per Sec. 4C.4.1. (*Automobile Parking Stalls*), any kitchen shall not be considered a habitable room.

5. **Fractional Space**

- a. When calculating required parking stalls in Sec. 4C.4.1. (*Automobile Parking Stalls*) results in the requirement of a fractional parking stall, any fraction up to and including 0.5 may be disregarded and any fraction over 0.5 requires one additional parking stall.
- b. Where required parking stalls in Sec. 4C.4.1. (*Automobile Parking Stalls*) is calculated for a lot including more than one use, parking spaces may be rounded after calculating the total number of required parking stalls for all uses on a lot.

E. **Exception**

1. **Accessible Parking**

The number of required automobile parking stalls may be reduced by the number of stalls deemed necessary in order to provide accessible parking stalls as required by California State access laws.

2. Amenity Space

Floor area provided as amenity space for site users shall be exempt from parking requirements.

3. Change of Use, Commercial Tenant Size

When allowed by the applicable Development Standards District, change of use projects of a size equal to or less than the square footage threshold specified by the applicable Development Standards District are not required to provide additional automobile parking stalls to accommodate a general commercial use that would otherwise require more automobile parking stalls than exists on-site.

4. Electric Vehicle Charging Stations

- a. Each electric vehicle charging station provided above the minimum required by *Article 9 (Green Building Code) of Chapter 9 (Building Regulations) of the LAMC* may be substituted for 2 required automobile parking stalls for the purpose of complying with any applicable minimum parking stall requirements of *Sec. 4C.4.1 (Automobile Parking Stalls)*.
 - i. Measurement. Where a multiport electric vehicle charger can simultaneously charge more than one vehicle, the number of electric vehicle charging stations shall be considered equivalent to the number of electric vehicles that can be simultaneously charged.
- b. An accessible parking stall with an access aisle served by electric vehicle supply equipment or an accessible parking stall with an aisle designated as a future electric vehicle charging space shall count as 2 required automobile parking stalls for the purpose of complying with any applicable minimum parking stall requirements of *Sec. 4C.4.1 (Automobile Parking Stalls)*.

5. Fire Pump Rooms

The number of required automobile parking stalls may be reduced by the number of stalls deemed necessary in order to install a water storage tank to enlarge an existing fire pump room, or to install a new fire pump room.

6. Historic Buildings and Buildings That Are At Least 25 Years Old

No additional parking is required for uses occupying a building that meets one of the following criteria:

- a. The building is a designated historic resource.
- b. The building is a surveyed historic resource.
- c. The building was constructed conforming to building and zoning codes in effect at the time it was built and is at least 25 years old. A certificate of occupancy, building permit, or other suitable documentation may be submitted as evidence to verify the date of construction.

7. Office Mixed-Use

- a. Any indoor recreation use, eating and drinking use, personal service use or retail use sharing a lot with an office use may provide parking at the same rate required for office uses subject to the following requirements:
 - i. The lot includes a total floor area of 50,000 square feet or greater.
 - ii. The office uses shall occupy a minimum of 75 percent of the floor area on the lot.
 - iii. The cumulative floor area dedicated to any combination of indoor recreation uses, eating and drinking uses, personal service uses or retail uses that may provide parking at the same rate required for office use shall not exceed 5 percent of the total floor area dedicated for office uses.
 - iv. Any floor area dedicated to any combination of indoor recreation uses, eating and drinking uses, personal service uses or retail uses that exceeds 5 percent of the total floor area dedicated for office use shall provide parking at the rate specified for the subject use in the applicable parking package assigned by the applied *Development Standards District (Part 4D)*.
- b. Any office use sharing a lot with a wholesale trade and warehousing use may provide parking at the same rate required for wholesale trade and warehousing uses when the following criteria are met:
 - i. The cumulative floor area dedicated to office uses that may provide parking at the same rate required for wholesale trade and warehousing uses shall not exceed 10 percent of the total floor area dedicated for wholesale trade and warehousing uses.
 - ii. Any floor area dedicated to office uses that exceeds 10 percent of the total floor area dedicated for wholesale trade and warehousing uses shall provide parking at the rate specified for office use in the applicable parking package assigned by the applied *Development Standards District (Part 4D)*.

8. Public Benefit Projects

Projects participating in an Affordable Housing Incentive Program, Community Benefits Program, or a General Incentive Program included in Article 9, Public Benefit Systems, may qualify for reduced required automobile parking as deemed eligible.

9. Small Business Tenant Space

Non-residential tenant spaces designated for commercial uses having a floor area of 1,500 square feet or less shall be exempt from requirements to provide automobile parking stalls. This exemption is limited to 2 tenant spaces per lot.

10. Substituting Required Automobile Parking with Bicycle Parking

- a. Required automobile parking stalls may be substituted with bicycle parking at a ratio of 1 automobile parking stall for every 4 bicycle parking spaces provided the bicycle parking spaces meet the applicable requirements of *Sec. 4C.3.1.C. (Required Bicycle Parking Spaces)*.
- b. Nonresidential uses may substitute up to 20% of the required automobile parking with bicycle parking. When a nonresidential use is located within 1,500 feet of a transit station, up to 30% of the required automobile parking stalls may be substituted with bicycle parking.
- c. Residential uses may substitute up to 10% of the required automobile parking with bicycle parking. When a residential use is located within 1,500 feet of a major transit stop, up to 15% of the required automobile parking stalls may be substituted with bicycle parking.
- d. Projects participating in an Affordable Housing Incentive Program, Community Benefits Program, or a General Incentive Program included in *Article 9. (Public Benefit Systems)*, may substitute up to 30% of the required automobile parking with bicycle parking, as deemed eligible.

F. Relief

1. A reduction in required automobile parking requirements may be requested in accordance with *Sec. 4C.4.3. (Alternative Parking Strategies)*.
2. A reduction in required automobile parking requirements of up to 20% may be requested in accordance with *Sec. 13.7.2 (Adjustments)*.
3. A deviation in required automobile parking requirements may be allowed as a variance in accordance with *Sec. 13.7.3 (Variance)*.

SEC. 4C.4.2. **CHANGE OF USE PARKING EXEMPTION**

A. **Intent**

To allow existing commercial spaces to change uses in response to evolving neighborhood and business conditions without requiring additional parking stalls, which may not be feasible without the loss of existing floor area and major site alterations.

B. **Applicability**

Applies to use modification project activities within a commercial tenant space having a floor area less than or equal to the square footage threshold specified by the applied Development Standards District (Part 4B).

C. **Standards**

1. No additional parking stalls beyond those that currently exist on-site shall be required for use modification project activities within a commercial tenant space having a floor area less than or equal to the square footage threshold specified by the applied Development Standards District (Part 4B).
2. When the applied Development Standard District (Part 4B) specifies "n/a" for change of use parking exemption, use modification project activities involving a commercial tenant space of any size is allowed without providing any additional parking.
3. The proposed use to occupy the commercial tenant space shall be designated for one of the following uses:
 - i. General Commercial (all)
 - ii. Indoor Recreation, Commercial
 - iii. Office, Government
 - iv. Social Services

D. **Measurement**

1. The size of an individual commercial tenant space shall be measured as the total floor area of a space designated to an individual tenant having no direct access to any other tenant space. Where multiple individual tenant spaces have direct access between the tenant spaces, all connected tenant spaces are considered the same tenant space for the purpose of measuring commercial tenant size.
2. Commercial tenant spaces may have direct access to common areas and shared facilities; however, common areas and shared facilities shall not be included in the calculation of commercial tenant size.
3. For the measurement of floor area see *Sec. 14.1.7. (Floor Area)*.

E. Relief

1. A deviation from the maximum floor area eligible for a change of use parking exemption of up to 20% may be requested in accordance with *Sec. 13B.7.2. (Adjustments)*.
2. A deviation from maximum floor area threshold specified by the applied Development Standards District (Part 4B) for a commercial tenant space to be eligible for the change of use parking exemption may be allowed as a variance in accordance with *Sec. 13B.5.3. (Variance)*.

SEC. 4C.4.3. **ALTERNATIVE PARKING STRATEGIES**

A. **Intent**

To provide opportunities for projects to reduce the number of required automobile parking stalls through alternative methods of accommodating arrival to a site and reduce demand for automobile parking.

B. **Applicability**

All projects required by *Sec. 4C.4.1 (Automobile Parking Stalls)* to provide automobile parking.

C. **Standards**

1. **General**

- a. A reduction in required automobile parking stalls through the provision of one or more alternative parking strategies may be authorized in accordance with *Sec. 13B.2.5. (Director Determination)*. Applicants that wish to provide an alternative parking strategy as a means of reducing the total number of required spaces shall submit a report which provides the following:
 - i. Detailed description of all uses involved in the alternative parking strategy, including location, floor area, seating capacity if applicable, and hours of operations.
 - ii. Anticipated parking demand generated by employees, tenants, residents, and visitors on an hourly basis, 24 hours per day, for seven consecutive days.
 - iii. Description of how an alternative parking strategy will alleviate the demand for a specified number of the total required parking stalls.
 - iv. Supplemental maps and plot plans deemed necessary for depicting all relevant components of an alternative parking strategy.
 - v. Supplemental market study detailing the complementary relationship between a mix of uses as deemed necessary for understanding the parking strategy.
- b. Additional documents, covenants, deed restrictions, or other agreements shall be executed and recorded as deemed necessary, in order to assure the continued maintenance, operation and viability of an approved alternative parking strategy, under the conditions set forth in the Director's Determination. Revisions to the parking strategy shall be submitted to the Director of Planning in a report documenting the revised manner in which the new parking strategy achieves the same intention and level of service as the originally approved parking strategy.

2. **Mixed Use**

When a site combines dwelling uses or office uses with on-site commercial uses that may serve the site's residents or employees the total number of required automobile parking stalls

- Automobile Parking -

may be reduced when an applicant demonstrates that the site's commercial uses will cater to the site's residents or employees. The total number of required automobile parking stalls may be reduced provided the mixed-use site meets all of the following criteria:

- a. Shall contain 50 or more dwelling units or 50,000 square feet or more dedicated to office use.
- b. Commercial uses shall be limited to indoor recreation, eating and drinking, personal service or retail use.
- c. The commercial uses shall be limited to 25 percent of total floor area.
- d. The mix of uses will sufficiently alleviate the demand for the specified number of required parking stalls.

3. Shared Parking

In order to take advantage of different peak periods of parking demand among nearby uses the total number of required automobile parking stalls may be reduced when an applicant demonstrates that automobile parking stalls can be shared among multiple uses. The parking strategy shall meet all of the following criteria:

- a. A shared parking facility shall be located within a 750-foot walking distance of each participating use.
- b. Participating uses shall have mutually exclusive periods of peak parking demand.
- c. The shared parking strategy will sufficiently alleviate the demand for the specified number of required parking stalls.

4. Proximity to Public Transportation

Uses within walking distance of a public transit facility may take advantage of increased transit ridership among employees, tenants and visitors and a decreased demand for automobile parking. The total number of required automobile parking stalls may be reduced provided the parking strategy meets all of the following criteria:

- a. A use shall be located within a 1,500-foot walking distance of public transit. For this purpose, public transit means a location, including, but not limited to, a bus stop or train station, where the public may access buses, trains, subways, and other forms of transportation that charge set fares, run on fixed routes, and are available to the public. A public transit stop or station that is in development may also apply if the anticipated operating date is within three years.
- b. The nearby public transit facility will sufficiently alleviate the demand for the specified number of required parking stalls.

5. Shuttle Service

Uses generating travel patterns whereby a majority of employees or visitors arrive and depart within the same time periods may operate a viable shuttle service that decreases the demand for automobile parking.

Criteria:

- a. A shuttle shall provide scheduled service between the use and a location that can accommodate the arrival of shuttle users, such as a park and ride facility or public transit station or stop.
- b. A majority of shuttle users arrive and depart roughly within the same three hour period.
- c. The planned shuttle service will sufficiently alleviate the demand for the specified number of required parking stalls.

6. Designated Passenger Loading Area

Uses that can accommodate a high share of arrivals and departures through dynamic ridesharing or taxi services when provided a safe and efficient passenger loading area may have a decreased demand for automobile parking.

Criteria:

- a. A designated passenger loading area shall be located within a 300-foot walking distance of a street facing entrance to the use it serves. Travel between a designated passenger loading area and the use being served shall not require pedestrians to cross streets.
- b. The passenger loading area shall not be placed within 75 feet of an intersection.
- c. The passenger loading area shall provide sufficient space for a vehicle to pull out of roadway traffic and safely load and unload passengers without interfering with traffic flow.
- d. The passenger loading area shall not decrease sidewalk space for pedestrians or impede pedestrian movement.
- e. Passenger loading areas shall be clearly indicated with signage.
- f. The designated passenger loading area will sufficiently alleviate the demand for the specified number of required parking stalls.

D. Measurement

1. For measurement of walking distance see *Sec. 14.1.3.B. (Distance, Walking)*.
2. Peak period demand is determined based on the following:

- Automobile Parking -

- a. For projects that have obtained a certificate of occupancy, this analysis shall be conducted on an hourly basis, 24 hours per day, for seven consecutive days to identify the maximum average number of automobiles on the lot per hour.
- b. For projects that have not yet obtained a certificate of occupancy, this analysis shall be conducted on an hourly basis, 24 hours per day, for seven consecutive days to identify the maximum average number of automobiles per hour on a lot serving a similar use.

E. Relief

A deviation from any alternative parking strategy dimensional standard of up to 10% may be requested in accordance with *Sec. 13B.5.2 (Adjustment)*.

SEC. 4C.4.4. **PARKING AREA DESIGN**

A. **Intent**

To ensure parking areas provide sufficient accommodation for automobile parking.

B. **Applicability**

Parking area design standards are applicable to every parking area containing automobile parking stalls.

C. **Standards**

1. **Automobile Circulation**

All portions of a parking area, including public parking structures, shall be accessible by automobile to all other portions of a parking area without requiring the use of any public street. Alleys may be used for circulation between parking areas. LADOT may allow use of the public street for this purpose where they determine that it is not detrimental to the flow of traffic.

2. **Location of Parking Stalls**

- a. All required automobile parking stalls shall be located in an off-street parking area.
- b. The required automobile parking stalls shall be provided either on the same lot as the use they are intended to serve or on another lot not more than a 750-foot walking distance of a street facing entrance to the use intended to be served by the required parking. An alternative parking strategy provided in accordance with *Sec. 4C.4.3. (Alternative Parking Strategies)* may be approved to exceed this distance.
- c. Automobile parking is not permitted within the primary street parking setbacks, side street parking setbacks and any special lot line parking setbacks established by the applicable Frontage District in accordance with *Sec. 3C.2.1. (Frontage Setback)*.
- d. Automobile parking is not permitted within any portion of a site designated to be used as lot amenity space or residential amenity space in accordance with *Div. 2C.3. (Amenity)*.

3. **Automobile Maneuvering**

- a. Each automobile parking stall shall be so located that no automobile is required to reverse onto any public street or sidewalk to leave the parking stall, parking bay or driveway, except where the automobile parking facility serves 4 parking stalls or less and where the driveway access is to a street other than a boulevard or avenue. An alley may be used for maneuvering in reverse.
- b. Each automobile parking stall shall be so located that parking maneuvers can be accomplished without driving onto a frontage parking setback area.

4. **Parking Stall Striping**

Each parking stall shall be clearly marked with striping for the entire required parking stall depth with the exception of parking areas on lots that contain less than 5 parking stalls, which are not required to mark parking stalls with striping.

5. **Barriers**

Bumper guards, wheel stops, steel posts, curbs, or other permanent installations that prevent vehicles from parking or maneuvering outside of parking areas, driveways and motor vehicle use areas.

6. **Paving**

All parking areas shall be paved with a material treatment meeting either the basic or alternative paving material standards.

a. **Basic Paving Material**

Automobile parking areas shall be paved with either hard, durable asphaltic paving which has been mixed at a plant and is at least 2 inches thick after compaction, with Portland cement paving at least 3 inches thick.

b. **Alternate Paving Materials**

- i. Automobile parking areas shall be paved with porous asphalt, porous concrete, permeable interlocking concrete pavers, permeable pavers, decomposed granite, crushed rock, gravel, or restrained systems (a plastic or concrete grid system confined on all sides to restrict lateral movement, and filled with gravel or grass in the voids).
- ii. Alternate paving materials are subject to the following standards:
 - a) Paving materials located in a designated fire lane must be approved by LAFD.
 - b) Permeable interlocking concrete pavers and permeable pavers shall have a minimum thickness of 80 mm (3.14 inches).
 - c) If plantings are an element of the alternative paving material, the irrigation system shall not utilize potable water except for plant establishment.
 - d) Products and underlying drainage material shall be installed per manufacturers' specifications. Sub-grade soils shall be compacted as required per the product installation specifications.
 - e) Decomposed granite, crushed rock and gravel shall only be allowed for parking areas serving 1 or 2 dwelling units.

7. **Lighting**

Parking areas shall be illuminated in accordance with *Sec. 4C.11.1 (Outdoor Lighting)*.

8. Parking Stall Obstructions

No fence, wall, partition, column, post or similar obstruction may be located within 10 inches of a parking stall along its longest dimension unless the obstruction is located a minimum of 14 feet from the drive aisle measured parallel to the parking stall. Parking stalls provided in 1L or 2L Density Districts are exempt from this standard.

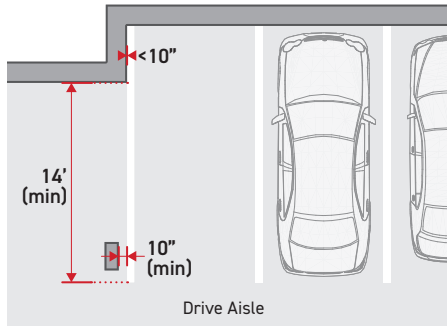

9. Parking Lots

For additional standards for parking lots see *Sec. 4C.4.4. (Parking Lot Design)*.

10. Structured Parking

For additional standards for structured parking see *Sec. 4C.4.6. (Parking Structure Design)*.

11. Parking Stall Dimensions

All automobile parking stalls shall meet the minimum dimension standards in the table below:

PARKING STALL DIMENSIONS					
Parking Stall		Dimension	Parking Stall Type		
STALL TYPE	STALL ANGLE		STANDARD	COMPACT	TANDEM
Perpendicular and Angled	>0°-90°	Width (min)	8'-4"	7'-6"	8'-4"
		Depth (min)	18'-0"	15'-0"	33'-0"
Parallel (Typical)	0°	Width (min)	8'-0"	7'-6"	n/a
		Depth (min)	26'-0"	23'-0"	n/a
Parallel (End Stall)	0°	Width (min)	8'-0"	7'-6"	n/a
		Depth (min)	30'-0"	27'-0"	n/a

12. Compact Parking

- a. All parking stalls in excess of the required number of parking stalls in *Sec. 4C.4.1. (Required Automobile Parking Stalls)* may be compact parking stalls.
- b. All parking stalls in excess of one parking stall per dwelling unit may be compact parking stalls.
- c. In each parking area containing 10 or more parking stalls, a maximum of 40% of the required stalls may be compact parking stalls. Such restriction shall not apply to parking stalls in excess of the number of required stalls.
- d. All compact stalls shall be clearly and visibly striped and labeled for compact car use only.

13. Tandem Parking

Automobiles may be parked in tandem in a private parking area serving a residential use, where the tandem parking is not more than two cars in depth. Tandem parking is not allowed for recreational vehicles or guest parking provided as part of a private parking area serving a residential use.

14. Parking Bay Dimensions

- a. The minimum width of each parking bay is determined by the stall width and parking stall angle of the parking stalls in accordance with the table below:

PARKING BAY WIDTH					
Parking Stall		One-Way Drive Aisle		Two-Way Drive Aisle	
ANGLE	WIDTH	DOUBLE LOADED	SINGLE LOADED	DOUBLE LOADED	SINGLE LOADED
0° (Parallel)	8'-0"	28'-0"	18'-0"	36'-0"	28'-0"
30°	7'-6"	40'-0"	26'-0"	48'-2"	34'-0"
	8'-4"	43'-0"	27'-6"	51'-2"	35'-6"
	8'-6"	43'-0"	27'-6"	51'-2"	35'-6"
	9'-0"	43'-0"	27'-6"	51'-2"	35'-6"
45°	7'-6"	44'-4"	28'-2"	52'-1"	36'-3"
	8'-4"	50'-3"	31'-11"	56'-4"	38'-6"
	8'-6"	49'-10"	31'-6"	56'-4"	38'-6"
	9'-0"	48'-7"	30'-3"	56'-4"	38'-4"
60°	7'-6"	49'-4"	32'-8"	54'-1"	37'-11"
	8'-4"	56'-5"	37'-3"	59'-11"	41'-1"
	8'-6"	55'-11"	36'-9"	59'-9"	40'-11"
	9'-0"	54'-8"	35'-3"	59'-3"	40'-7"
90°	7'-6"	55'-4"	40'-4"	55'-4"	40'-4"
	8'-4"	64'-0"	46'-0"	64'-0"	46'-0"
	8'-6"	63'-4"	45'-4"	63'-4"	45'-4"
	9'-0"	61'-4"	43'-4"	61'-4"	43'-4"

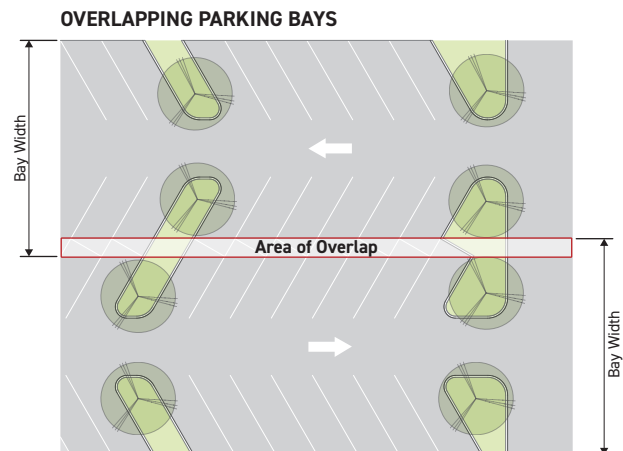
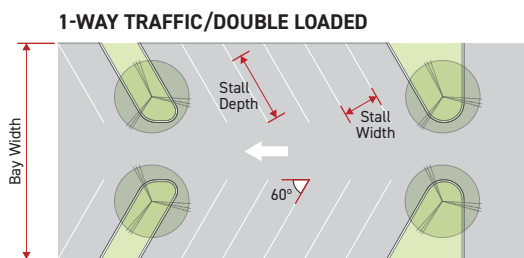
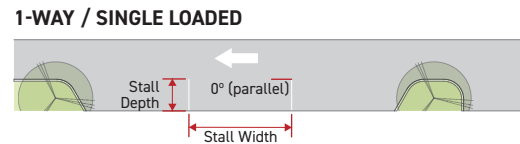
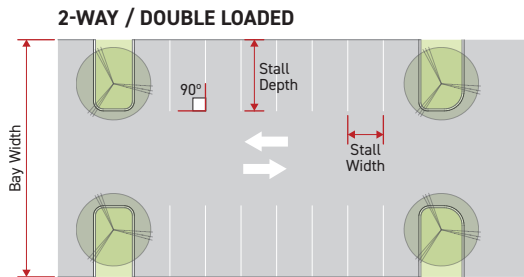

- Automobile Parking -

- b. Where parking stalls of two bays interlock the parking bays may overlap.
- c. Any tandem stalls provided shall increase the minimum parking bay width by 15' tandem stalls are provided on only one side of a drive aisle and 30' where tandem stalls are provided on two sides of a drive aisle.
- d. Parking bay dimensions other than those specified may be approved by the Superintendent of Building based on vehicle maneuvering requirements on the site.

15. Mechanical Automobile Lifts and Robotic Parking Structures

- a. The stacking of 2 or more automobiles using a mechanical car lift or computerized parking structure is permitted.
- b. All automobile parking stalls included in a mechanical lift or robotic parking structure shall meet the minimum dimension standards in the table below:

PARKING STALL DIMENSIONS		
Dimension	Parking Stall Type	
	STANDARD	COMPACT
Clear Width (min)	8'-0"	7'-0"
Clear Height (min)	7'-0"	6'-0"

- d. The platform of the mechanical lift on which the automobile is first placed shall be individually accessed and shall be placed so that the location of the platform and access to the platform meet all applicable requirements of Division 4C.4. (Automobile Parking).
- e. The lift equipment or computerized parking structure shall meet any applicable building, mechanical and electrical code requirements as approved by the Department of Building and Safety.
- f. All mechanical automobile lifts and robotic parking structures shall be subject to 4C.4.3.C.2. (*Location of Parking Stalls*).

D. Measurement

1. Parking Stall Width

The narrowest horizontal distance between opposite edges of a parking stall.

2. Parking Stall Depth

The horizontal distance measured perpendicular to the parking stall width from one edge of a parking stall to the opposite edge. A minimum parking stall depth shall be met for all portions of the parking stall width.

3. **Parking Bay Width**

The horizontal distance between opposite edges of a parking bay measured perpendicular to the drive lane.

4. **Parking Angle**

The angle measured from the long edge of a parking stall to the drive lane.

5. **Clear Height**

Minimum clear height is measured as the vertical dimension of a parking stall at the lowest point, from finished grade or floor elevation to the ceiling or other fixed obstruction for the full width and depth of the parking stall.

6. **Clear Width**

Minimum clear width is measured as the horizontal dimension of a parking stall at the narrowest point between walls or other fixed obstructions for the full depth of the parking stall.

E. **Exceptions**

A parking area providing attendants to park the vehicles at all times when the parking area is open for use does not have to meet the requirements of the following of *Sec. 4C.4.4.C.11. (Parking Stall Dimensions)* and *Sec. 4C.4.4.C.14. (Parking Bay Dimensions)*.

F. **Relief**

1. A deviation from parking area design standards may be requested in accordance with *Sec. 13B.5.1. (Alternative Compliance)*.
2. A reduction in required number of standard parking stalls by 10% in lieu of compact parking stalls may be requested in accordance with *Sec. 13.7.2 (Adjustments)*.
3. A deviation in required parking stall dimensions or parking bay dimensions may be allowed as a variance in accordance with *Sec. 13.7.3 (Variance)*.

SEC. 4C.4.5. **PARKING LOT DESIGN**

A. **Intent**

Ensure parking lots are designed to create safe, comfortable and attractive environments for users and pedestrians along the adjacent public right-of-way, while also mitigating heat island effects, absorbing noise pollution, managing stormwater runoff, sequestering carbon emissions and supporting urban biodiversity through landscaping and surface design.

B. **Applicability**

1. Parking lot design standards apply to all automobile parking areas that are not contained within a parking structure. For parking structure design standards see *Sec. 4C.4.5 (Parking Structure Design)*.
2. Parking lot landscaping standards apply to all automobile parking areas containing 5 or more parking stalls.

C. **Standards**

1. **Surfacing**

- a. All automobile parking areas shall be graded and drained to collect, retain and infiltrate surface water on-site by applying Low Impact Development practices and standards in accordance with *LAMC Section 64.72. (Stormwater Pollution Control Measures for Development Planning and Construction Activities)*.
- b. Parking lots shall be surfaced with hard, durable asphaltic paving which has been mixed at a plant and is at least two inches thick after compaction, with portland cement paving at least three inches thick or with an alternative paving material described below.
 - i. Alternative paving materials include the following: porous asphalt, porous concrete, permeable interlocking concrete pavers, permeable pavers, decomposed granite, crushed rock, gravel, and restrained systems (a plastic or concrete grid system confined on all sides to restrict lateral movement, and filled with gravel or grass in the voids.)
 - ii. Alternative paving materials are permitted for use in every parking lot, subject to the following standards:
 - a) Any product installed within areas designated by the Fire Department as a fire lane must be approved by the Fire Department.
 - b) Permeable interlocking concrete pavers and permeable pavers shall have a minimum thickness of 80 mm (3.14 inches).
 - c) If plantings are an element of the alternative paving material, the irrigation system shall not utilize potable water except for plant establishment.

- d) Products and underlying drainage material shall be installed per manufacturers' specifications. Sub-grade soils shall be compacted as required per the product installation specifications.
- e) Decomposed granite, crushed rock and gravel shall only be allowed for driveways and parking areas serving a maximum of two dwelling units.

2. **Parking Lot Landscaping**

a. **General**

- i. Projects may comply with either Option 1 or Option 2 in order to meet the requirements of this Section.
- ii. The required stall length of parking stalls may overhang the planting areas required by the parking lot landscaping standards by 2 feet or less.
- iii. All planting areas shall comply with *Sec. 4C.4.4. (Plant Design & Installation)* in addition to any planting area requirements of the chosen parking lot landscaping option.

b. Option 1: Prescriptive Standard

- i. Trees planted within a planting area located along a single row of parking stalls shall be provided at a rate of 1 large species tree or 2 small species trees for every 34 parking stalls.
- ii. Trees planted between two rows of parking stalls shall be provided at a rate of 1 large species tree (Sec. 4C.4.4.C.3.a.) or 2 small species trees (Sec. 4C.4.4.C.3.a.) for every 68 parking stalls.
- iii. Trees planted between two rows of parking stalls shall be provided at a rate of 1 large species tree (Sec. 4C.4.4.C.3.a.) or 2 small species trees (Sec. 4C.4.4.C.3.a.) for every 6 parking stalls.
- iv. Required trees shall be spaced evenly along the entire length of the required planting area.

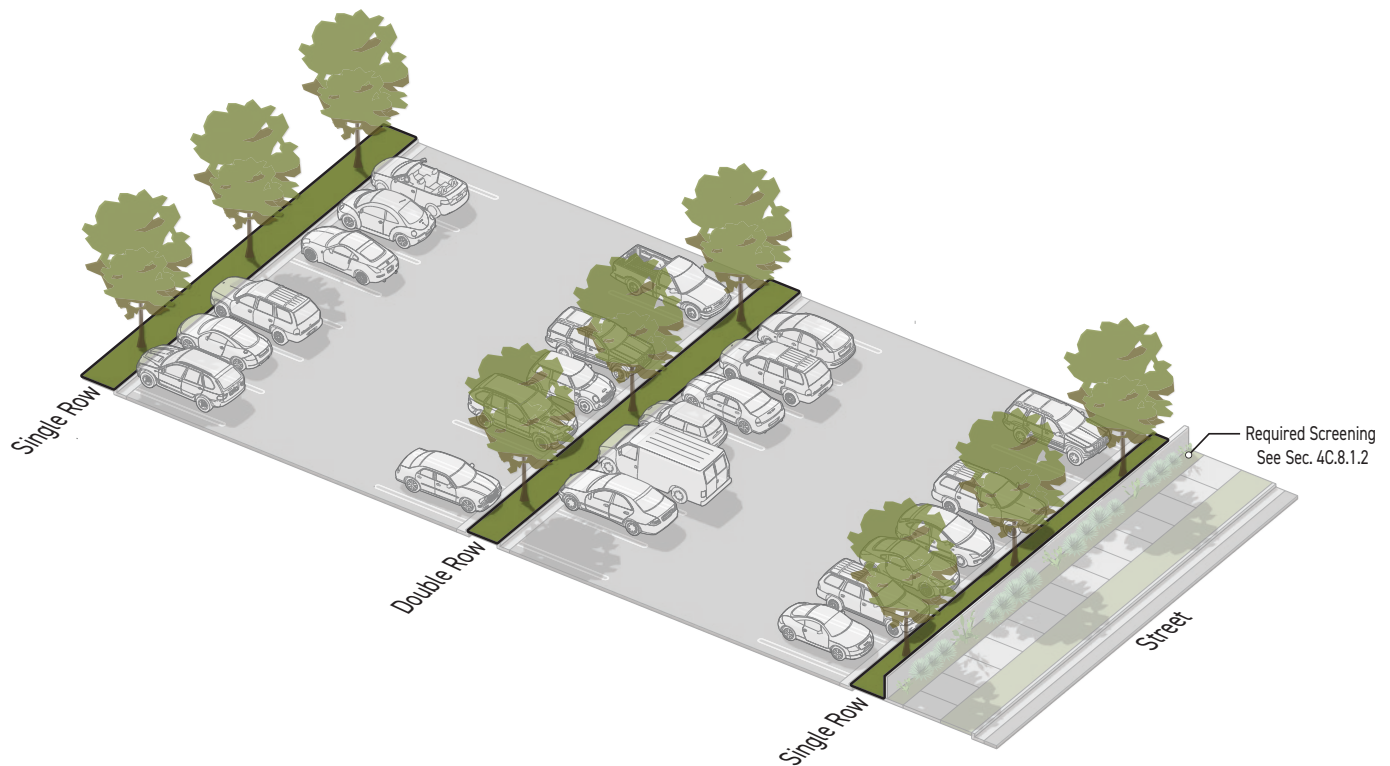

- v. When calculating the total number of trees results in a fraction of a tree, any fraction less than one-half may be disregarded and any fraction of one-half or more will require one additional tree.

c. Option 2: Performance-Based Standard

Trees shall be planted so that at least 50% of all parking lot stalls will be shaded by tree canopy after 10 years of planting.

3. Screening

- a. Where a parking lot faces a frontage lot line, common lot line or an alley lot line the entire length of the parking lot shall be screened.
 - i. A type *F2 frontage screen* (Sec. 4C.8.1.C.2.b.) or a type *F3 frontage screen* (Sec. 4C.8.1.C.2.c.) is required between the parking lot and frontage lot lines for any portion of the length of the parking lot that faces a frontage lot line.
 - ii. A Type *T1 transition screen* (Sec. 4C.8.2.C.2.a.) is required between the parking lot and common lot lines shared with lots having a 1L, 2L, 3L or 4L Density District for any portion of the length of the parking lot that faces a common lot line.
 - iii. A Type *T1 transition screen* (Sec. 4C.8.2.C.2.a.) is required between the parking lot and alley lot lines for any portion of the length of the parking lot that faces an alley lot line where lots zoned with a 1L, 2L, 3L or 4L Density District abut the opposite side of the alley right-of-way.
- b. The required stall length of parking stalls may overhang the planting area of a required frontage screen or transition screen by 2 feet or less.
- c. Screens may only be located in a frontage yard where they comply with frontage yard fences and wall standards in the applied *Frontage District (Part 3B)*.

4. Containment Perimeter

Parking lots shall include a containment perimeter that obstructs motor vehicles from leaving the designated parking lot. The containment perimeter shall be providing using one or more of the following containment methods around the entire perimeter except for crossings and access points required for driveways, drive aisles, pedestrian accessways, pedestrian passageways:

- a. Continuous curbs of no less than 4 inches in height.
- b. Permanent bollards, walls, raised planters, or a similar containment method having a height no less than 30 inches and having a clear width of no more than 66 inches.
- c. A planting area meeting Sec. 4C.6.4.C.2 (*Planting Areas*) with no horizontal dimension less than 5 feet.

5. Lighting

Parking areas shall be illuminated in accordance with Sec. 4C.10.1. (*Outdoor Lighting*).

D. Measurement

1. For lot line determination see *Sec. 14.1.12 (Lot Line Determination)*.
2. For frontage yard designation see *Sec. 14.1.20.G. (Frontage yard)*.
3. For parking frontage setback see *Sec. 3C.2.1. (Parking Setback)*.
4. For the length that a parking lot is facing a lot line see *Sec. 14.1.6. (Facing)*.
5. To measure planting area width see *Sec. 4C.4.4.D.1 (Planting Area Width)*.

E. Relief

1. A deviation from any parking lot design dimensional standard of up to 10% may be requested in accordance with *Sec. 13B.5.2 (Adjustment)*.
2. A deviation from any parking lot design standard may be allowed as a variance in accordance with *Sec. 13B.5.3 (Variance)*.

SEC. 4C.4.6. **PARKING STRUCTURE DESIGN**

A. **Intent**

To limit the visual and environmental impact of motor vehicle use areas on the public realm to extent appropriate to the mobility context.

B. **Applicability**

1. **General**

Parking structure design standards apply to all parking structures.

2. **Primary St.**

Where the applied *Development Standard District (Part 4B)* specifies a parking structure design treatment under the "Primary St." heading, the specified parking structure design standards apply to all portions of a structure that face a primary street lot line and include a motor vehicle use area within 30 feet of the primary street lot line-facing facade.

3. **Side St.**

- a. Where the applied *Development Standard District (Part 4B)* specifies a parking structure design treatment under the "Side St." heading, the specified parking structure design treatment standards apply to all portions of a structure that face a side street lot line and include a motor vehicle use area within 30 feet of the side street lot line-facing facade.
- b. On a lot zoned with a *Dual Frontage District (Div 4B.8.)*, the parking structure design treatment standards specified under the "Side St." heading, apply to all portions of a structure that face a special lot line and include a motor vehicle use area within 30 feet of the special lot line facing facade.

4. **Parking Garage**

Where the applied *Development Standard District (Part 4B)* specifies a parking structure design treatment under the "Parking Garage" subheading, the specified parking structure design treatment standards apply to all parking garages.

5. **Integrated Parking**

Where the applied *Development Standard District (Part 4B)* specifies a parking structure design treatment under the "Integrated Parking" subheading, the specified parking structure design treatment standards apply to structures including integrated parking.

6. **Ground Story**

Where the applied *Development Standard District (Part 4B)* specifies a parking structure design treatment for the ground story, the specified parking structure design treatment standards apply along the ground story facade.

7. Upper Stories

Where the applied *Development Standard District (Part 4B)* specifies a parking structure design treatment for upper stories, the specified parking structure design treatment standards apply along upper story facades.

C. Standards

1. General

- a. Parking structure design treatments are hierarchical according to the following order:
 - i. Screened Parking
 - ii. Concealed Parking
 - iii. Adaptable Parking
 - iv. Wrapped Parking
- b. If a treatment listed with a lower number is specified by the applied *Development Standards District (Part 4B)*, the applicant may choose to meet the standards of a treatment with a higher number.
- c. Ground story motor vehicle use areas located in a parking structure shall also meet any parking setback standards specified by the applied *Frontage District (Part 3B)*.

2. Lighting

All luminaires located in parking structures shall meet the following standards:

- a. Luminaires shall meet the standards of *Sec. 4C.10.1. (Outdoor Lighting)*.
- b. Beam spread and glare zone from luminaires shall be contained within the parking structure.

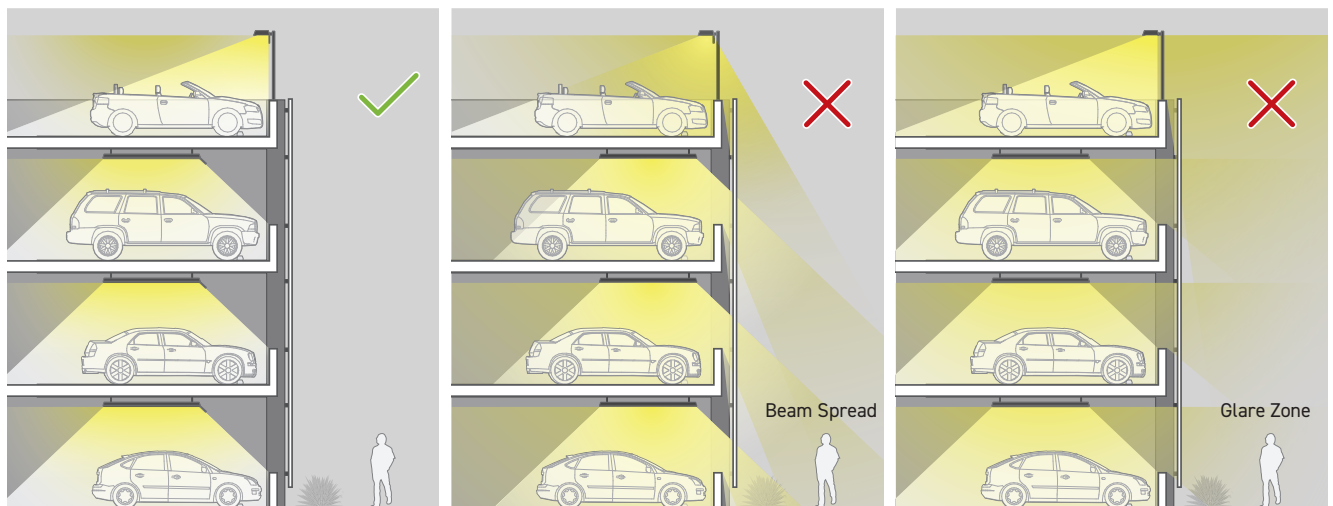

3. Parking Structure Design Treatments

a. Screened Parking

Intended to limit the visual and environmental impact of motor vehicle use areas on the public realm.

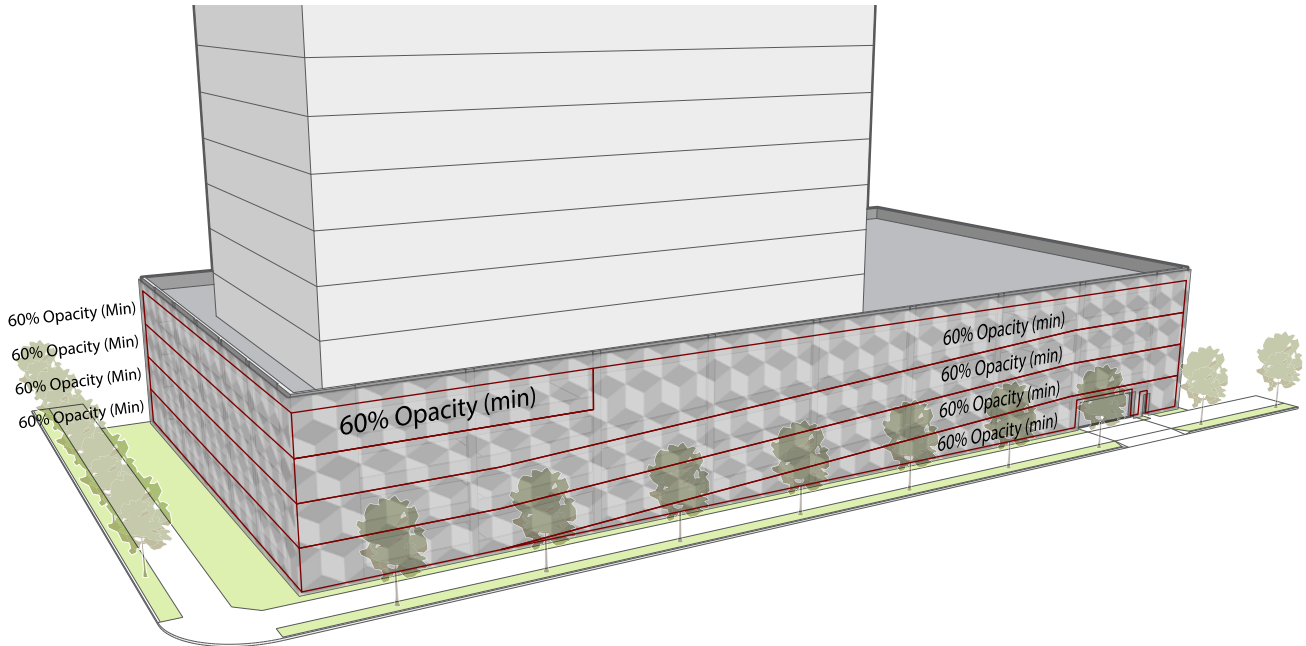

- i. Parking structure facades required to be screened shall meet any frontage standards required by the applicable Frontage District.
- ii. All above grade parking structure facades shall be screened with a permanent structure that meets the following standards:
 - a) Shall not have less than 60% opacity for any individual tier of parking measured in elevation projection.

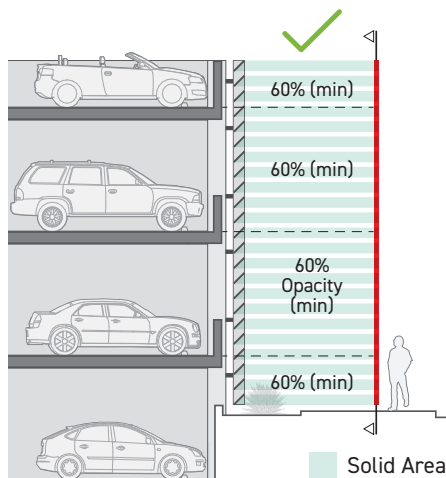

- Automobile Parking -

- b) Openings in screens shall be 4 inches or less in at least one dimension except for openings provided for pedestrian or vehicle access.

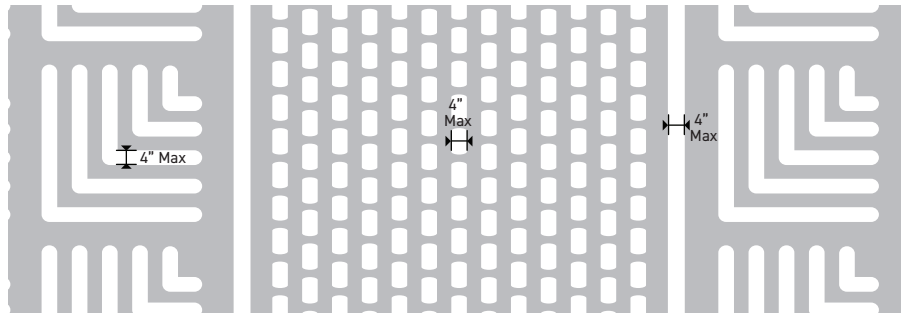

- c) Upper story parking screening, when projected from an angle of elevation of 45 degrees shall not have a lower opacity than when measured in elevation projection.
 - d) Parking structure screen openings accommodating automobile access are allowed for a width no greater than the maximum allowed driveway width allowed by the applicable Development Standards District.
 - e) Parking structure screen openings accommodating pedestrian accessways are allowed for a width no greater than 8 feet in width for each individual pedestrian accessway. Where an opening in the parking garage screening accommodates both pedestrian and automobile access, the maximum allowable opening width is 8 feet greater than the maximum allowed driveway width.
 - f) Parking structure screen openings shall have a height no greater than 1 story.
- iii. In addition to the screening above, a F-Screen 1 or F-Screen 2 frontage screen (Sec. 4C.8.1.C.2.) is required between ground story parking and all frontage lot lines.

b. Concealed Parking

Intended to entirely block views of cars, people and direct light from inside parking structures to the public realm.

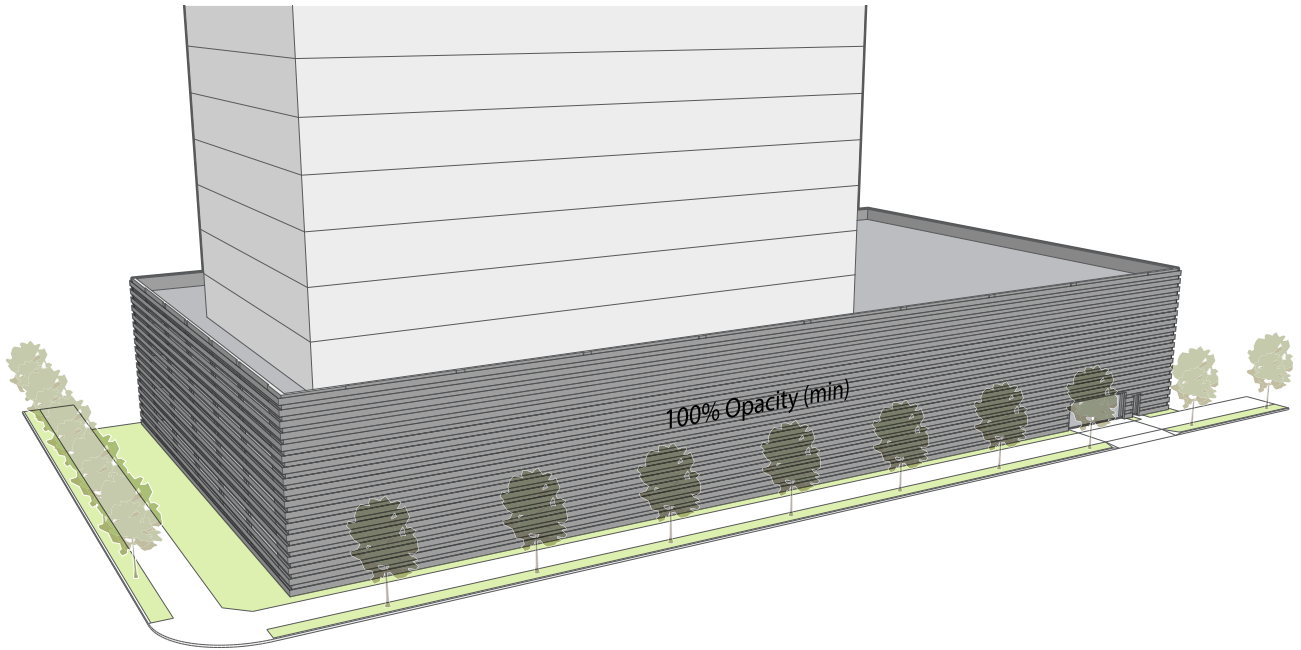

- i. Parking structure facades required to be concealed shall meet any frontage standards required by the applicable Frontage District.
- ii. All above-grade parking structure facades shall be screened with a permanent structure meeting the following standards:
 - a) Shall not have an opacity of less than 100%.

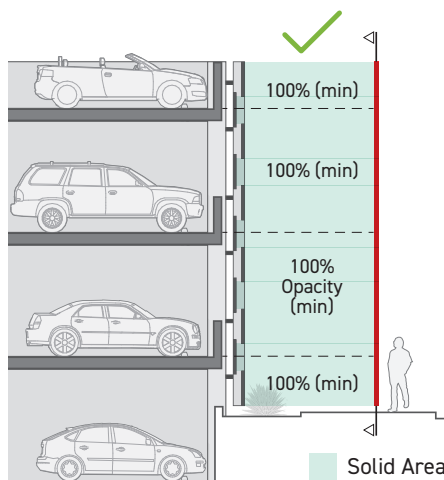

- b) Parking structure enclosures shall not include perforated metal screening products.

- Automobile Parking -

- c) Parking structure screen openings accommodating automobile access are allowed for a width no greater than the maximum allowed driveway width allowed by the applicable Development Standards District.
 - d) Parking structure screen openings accommodating pedestrian accessways are allowed for a width no greater than 8 feet in width for each individual pedestrian accessway. Where an opening in the parking garage screening accommodates both pedestrian and automobile access, the maximum allowable opening width is 8 feet greater than the maximum allowed driveway width.
 - e) Parking structure screen openings shall have a height no greater than 1 story.
- iii. In addition to the screening above, a type F-Screen 1 or F-Screen 2 frontage screen (Sec. 4C.8.1.C.3) is required between ground story parking and all frontage lot lines.

c. **Adaptable Parking**

Intended to ensure floors used for parking are built in a way that allows motor vehicle use areas to change to active uses in the future without significant structural renovation.

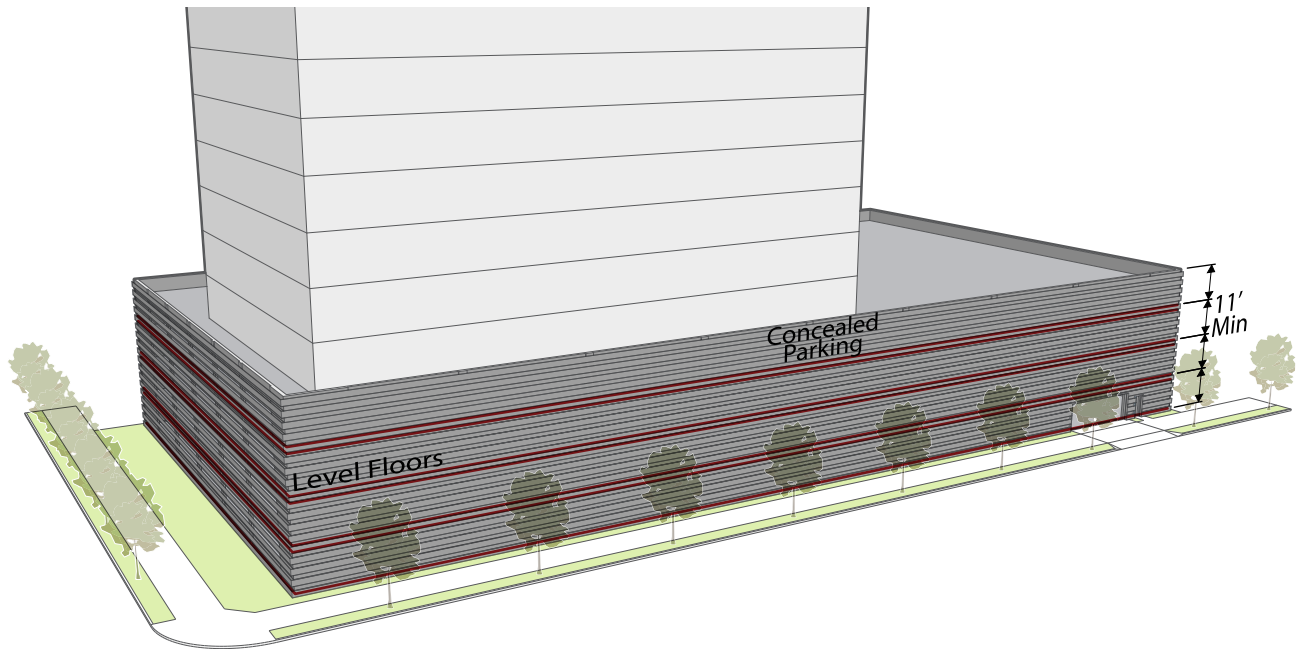

- i. Parking structure facades required to be adaptable shall meet any frontage standards required by the applicable Frontage District.
- ii. Where required to be adaptable by the applicable Development Standards District; parking structures shall meet the following standards for a minimum depth of 30 feet from the applicable street-facing building facade:
 - a) Floor plates shall be level except to the minimum extent required for drainage.
 - b) Structure shall be constructed to accommodate loads associated with office building corridors above first floor as indicated by the Los Angeles Building Code.
 - c) Floor to floor heights shall be a minimum of 11 feet.
- iii. All parking required to be adaptable shall also meet the standards for concealed parking (Sec. 4C.4.6.C.3.b.).

d. **Wrapped Parking**

Intended to ensure active uses along the public right-of-way in order to provide a human-scale and visual interest to buildings along streets and sidewalks, contributing to public safety, walkability and social engagement.



- i. Parking structure facades required to be wrapped shall meet any frontage standards required by the applicable Frontage District.

- ii. Where parking structures are required to be wrapped by the applicable Development Standards District; parking structures shall meet the following standards for the portion of the building width required to meet the minimum build-to width specified in the applicable Frontage District.
 - a) Parking and other motor vehicle use areas shall be separated from the frontage lot line by indoor active uses for a minimum depth of 15 feet measured from the applicable street-facing building face.
 - b) For the purpose of wrapping parking, active uses include indoor occupiable spaces designed and intended for tenants, residents or guests. Areas for circulation, storage, mechanical equipment, utilities, and waste collection shall not account for more than 15% of an area designated as an active use on any story.

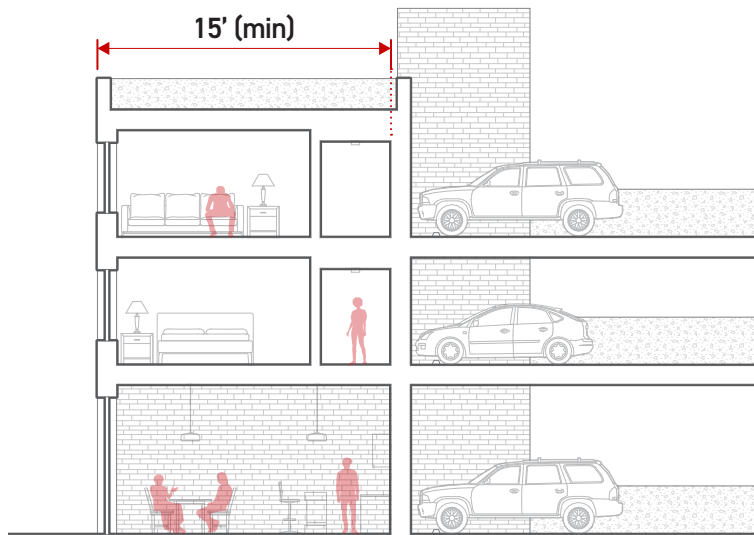

- iii. The portion of the building width not required to meet the minimum build-to width required by the applicable Frontage District may meet either the standards for wrapped parking or concealed parking (Sec. 4C.4.6.C.3.b.).

D. Measurement

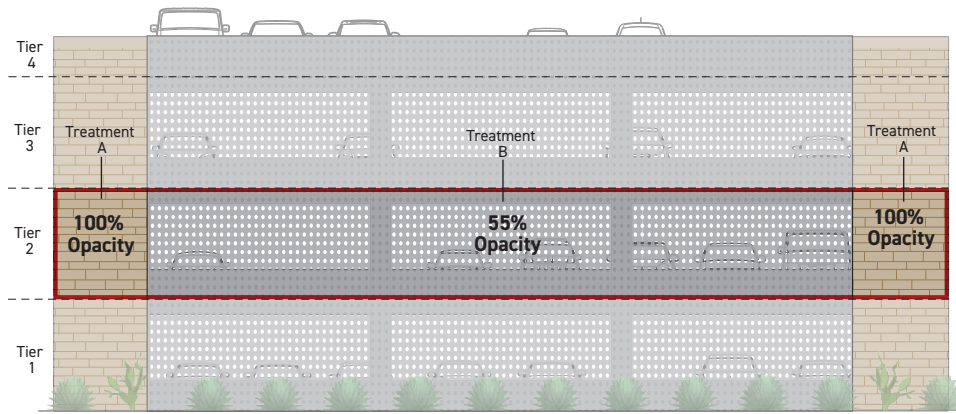

✓

TIER 2 OPACITY CALCULATION			
	% OPACITY	PORTION OF TOTAL FACADE AREA	WEIGHTED VALUE
TREATMENT A	100%	0.2	20%
TREATMENT B	55%	0.8	42%
TIER 2 TOTAL OPACITY			62%

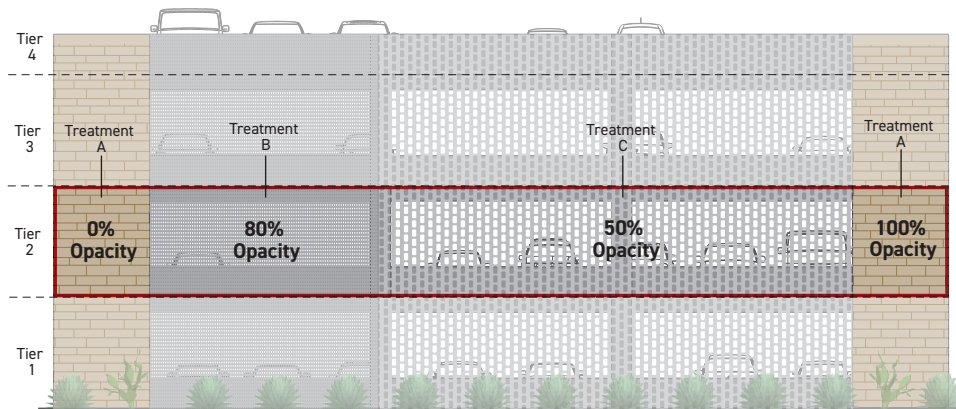

✓

TIER 2 OPACITY CALCULATION			
	% OPACITY	PORTION OF TOTAL FACADE AREA	WEIGHTED VALUE
TREATMENT A	100%	0.2	20%
TREATMENT B	80%	0.3	24%
TREATMENT C	50%	0.5	25%
TIER 2 TOTAL OPACITY			69%

1. Opacity

- a. Opacity of screening is calculated separately for each tier of parking on each building facade.
- b. Minimum opacity is measured as a percentage calculated as the sum of all solid areas on a parking facade area divided by the total parking facade area projected horizontally and perpendicular to the facade area. Also see *Sec. 14.1.13. (Opacity %)*.
- c. When a parking structure tier uses more than one screening treatment with varying opacities, the opacity for the entire tier is calculated as a weighted average of the opacities of all the treatments used on the tier. The opacity of each screening treatment is weighted by the percent of the total parking screen facade area covered by that screening treatment.
- d. For the purpose of measuring opacity, above-grade portions of underground and ground story parking structure facade area using a green wall meeting the standards of *Sec. 3C.4.2.E.3.c. (Green Wall)* are considered to have an opacity of 60%.

2. Parking Structure Screen Openings

- a. Parking structure screen opening width is measured as the maximum horizontal dimension of the area not including the parking structure treatment required by *Part 4B. (Development Standard Districts)*. Parking structure screen opening width is measured parallel to the parking structure facade.
- b. Parking structure screen opening height is measured as the maximum vertical dimension of the area on a parking structure facade that does not include the parking structure treatment required by *Part 4B. (Development Standard Districts)*.

E. Exceptions

Sites that have a total lot area of less than 30,000 square feet and contain parking structures where upper stories are required to comply with *Sec. 4C.4.6.C.3.d. (Wrapped Parking)* may design upper story portions of parking structures to comply with the following standards rather than with *Sec. 4C.4.6.C.3.d. (Wrapped Parking)*:

1. Upper story motor vehicle use areas shall be in a fully enclosed building; and
2. The parking structure facades shall meet all standards specified by the applied *Frontage District (Part 3B)*.

F. Relief

1. An alternative to any parking structure design standards may be requested in accordance with *Sec. 13B.5.1 (Alternative Compliance)*.
2. A deviation from any parking structure design dimensional standard of up to 10% may be requested in accordance with *Sec. 13B.5.2 (Adjustment)*.
3. A deviation from any parking structure design standard may be allowed as a variance in accordance with *Sec. 13B.5.3 (Variance)*.

DIV. 4C.5. **TRANSPORTATION DEMAND MANAGEMENT**

SEC. 4C.5.1. **SMALL PROJECTS**

A. **Intent**

To alter travel behavior through programs of incentives, services, and policies appropriate for small projects, including encouraging the use of alternatives to single-occupancy vehicles such as public transit, cycling, walking, carpooling/vanpooling and changes in work-schedule that move trips out of the peak period or eliminates them altogether.

B. **Applicability**

Small projects transportation demand management standards apply to new construction and additions adding more than 25,000 square feet of non-residential floor area.

C. **Standards**

Applicants shall execute and record a covenant and agreement to the satisfaction of LADOT, to provide and continually maintain in a state of good repair a bulletin board, display case, or kiosk meeting the following standards:

1. The required bulletin board, display case or kiosk shall be located where the greatest number of employees are likely to see it.
2. The required bulletin board, display case or kiosk display shall include, but is not limited to, the following:
 - a. Current routes and schedules for public transit serving the site;
 - b. Telephone numbers for referrals on transportation information including numbers for the regional ridesharing agency and local transit operations;
 - c. Ridesharing promotion material supplied by commuter-oriented organizations;
 - d. Regional/local bicycle route and facility information;
 - e. A listing of on-site services or facilities which are available for carpool, vanpool, bicycle, and transit riders.

D. **Measurement**

[None]

E. **Relief**

1. An alternative to small project transportation demand management standards may be requested in accordance with Sec. 13B.5.1 (Alternative Compliance).

2. A deviation from any small project transportation demand management dimensional standard of up to 10% may be requested in accordance with *Sec. 13B.5.2 (Adjustment)*.
3. A deviation from any small project transportation demand management standard may be allowed as a variance in accordance with *Sec. 13B.5.3 (Variance)*.
4. In cases of extreme hardship, duly established to its satisfaction, the City Council, acting in its legislative capacity, and by resolution, may grant an exemption from any/or all the provisions of *Sec 4C.5.1. (Small Projects)*. In granting such an exemption, the City Council shall make the following findings:
 - a. Specific features of the development make it infeasible to satisfy all of the provisions of this subsection; and
 - b. The applicant has committed to provide equivalent alternative measures to reduce vehicle trips.

SEC. 4C.5.2. **MEDIUM PROJECTS**

A. **Intent**

To alter travel behavior through programs of incentives, services, and policies appropriate for medium projects, including encouraging the use of alternatives to single-occupancy vehicles such as public transit, cycling, walking, carpooling/vanpooling and changes in work-schedule that move trips out of the peak period or eliminates them altogether.

B. **Applicability**

Medium projects transportation demand management standards apply to new construction and additions adding more than 50,000 square feet of non-residential floor area.

C. **Standards**

Applicants shall execute and record a covenant and agreement to the satisfaction of LADOT, to provide and continually maintain in a state of good repair the following trip reduction features:

1. All trip reduction features required for small projects (*Sec. 4C.5.1.*).
2. A designated parking area for employee carpools and vanpools as close as practical to the main pedestrian entrance(s) of the building(s). This area shall include at least ten percent of the parking stalls required for the site. The spaces shall be signed and striped sufficient to meet the employee demand for such spaces. The carpool/vanpool parking area shall be identified on the driveway and circulation plan upon application for a building permit;
3. One permanent, clearly identified (signed and striped) carpool/vanpool parking stall for the first 50,000 to 100,000 square feet of floor area and one additional permanent, clearly identified (signed and striped) carpool/vanpool parking stall for any development over 100,000 square feet of floor area;

4. Parking stalls clearly identified (signed and striped) shall be provided in the designated carpool/vanpool parking area at any time during the building's occupancy sufficient to meet employee demand for such spaces. Absent such demand, parking stalls within the designated carpool/vanpool parking area may be used by other vehicles;
5. No signed and striped parking stalls for carpool/vanpool parking shall displace any handicapped parking;
6. A statement that preferential carpool/vanpool spaces are available on-site and a description of the method for obtaining permission to use such spaces shall be included on the required transportation information board;
7. Additional carpool/vanpool spaces within the designated preferential area will be signed and striped for the use of ridesharing employees based on demand for such spaces;
8. A minimum vertical clearance of 7 feet 2 inches shall be provided for all parking stalls and accessways used by vanpool vehicles when located within a parking structure;
9. Bicycle parking shall be provided in conformance with *Div. 4C.3 (Bicycle Parking)*.

D. **Measurement**

[None]

E. **Relief**

1. An alternative to medium project transportation demand management standards may be requested in accordance with Sec. 13B.5.1 (Alternative Compliance).
2. A deviation from any medium project transportation demand management dimensional standard of up to 10% may be requested in accordance with Sec. 13B.5.2 (Adjustment).
3. A deviation from any medium project transportation demand management standard may be allowed as a variance in accordance with Sec. 13B.5.3 (Variance).
4. In cases of extreme hardship, duly established to its satisfaction, the City Council, acting in its legislative capacity, and by resolution, may grant an exemption from any/or all the provisions of *Sec 4C.5.2. (Medium Projects)*. In granting such an exemption, the City Council shall make the following findings:
 - a. Specific features of the development make it infeasible to satisfy all of the provisions of this subsection; and
 - b. The applicant has committed to provide equivalent alternative measures to reduce vehicle trips.

SEC. 4C.5.3. **LARGE PROJECTS**

A. **Intent**

To alter travel behavior through programs of incentives, services, and policies appropriate for large projects, including encouraging the use of alternatives to single-occupancy vehicles such as public transit, cycling, walking, carpooling/vanpooling and changes in work-schedule that move trips out of the peak period or eliminates them altogether.

B. **Applicability**

Large projects transportation demand management standards apply to new construction or additions adding more than 100,000 square feet of non-residential floor area.

C. **Standards**

Applicants shall execute and record a covenant and agreement to the satisfaction of LADOT, to provide and continually maintain in a state of good repair the following trip reduction features:

1. All trip reduction features required for small projects (*Sec. 4C.5.1.*).
2. All trip reduction features required for small or medium projects (*Sec. 4C.5.2.*).
3. A safe and convenient area in which carpool/vanpool vehicles may load and unload passengers other than in their assigned parking area;
4. Sidewalks or other designated passageways following direct and safe routes from the external pedestrian circulation system to each building in the development;
5. If determined necessary by the City to mitigate the project impact, bus stop improvements shall be provided. The City will consult with the local bus service providers in determining appropriate improvements. When locating bus stops or planning building entrances, entrances shall be designed to provide safe and efficient access to nearby transit stations/stops;
6. Safe and convenient access from the external circulation system to bicycle parking facilities on-site.

D. **Measurement**

[Reserved]

E. **Relief**

1. An alternative to large project transportation demand management standards may be requested in accordance with Sec. 13B.5.1 (Alternative Compliance).
2. A deviation from any large project transportation demand management dimensional standard of up to 10% may be requested in accordance with Sec. 13B.5.2 (Adjustment).

3. A deviation from any large project transportation demand management standard may be allowed as a variance in accordance with Sec. 13B.5.3 (Variance).
4. In cases of extreme hardship, duly established to its satisfaction, the City Council, acting in its legislative capacity, and by resolution, may grant an exemption from any/or all the provisions of Sec 4C.5.3. (*Large Projects*). In granting such an exemption, the City Council shall make the following findings:
 - a. Specific features of the development make it infeasible to satisfy all of the provisions of this subsection; and
 - b. The applicant has committed to provide equivalent alternative measures to reduce vehicle trips.

F. **Monitoring**

LADOT shall be responsible for monitoring the owner/applicant's continual implementation and maintenance of the project trip reduction features required by this ordinance.

DIV. 4C.6. **PLANTS**

SEC. 4C.6.1. **PROTECTED VEGETATION**

Provisions for protected vegetation are outlined in *LAMC Sec. 46.02. (Requirements for Public Works Permits to Relocate or Remove Protected Trees and Shrubs)* and *Sec. 11.1.3.P. (Protected Vegetation Regulations)*.

SEC. 4C.6.2. **REQUIRED TREES**

A. **Intent**

To maintain and increase the City's tree canopy, reduce consumption of electricity, improve air quality, promote infiltration of stormwater runoff, offset urban heat island effect, mitigate noise pollution, sequester carbon and support urban biodiversity.

B. **Applicability**

Any new construction or site modification shall comply with the required tree standards.

C. **Standards**

1. One *large species tree (Sec. 4C.4.4.C.3.a.i.a.)* or two *small species trees (Sec. 4C.4.4.C.3.a.i.b.)* shall be planted for every 4,000 square feet of total floor area constructed on a lot. For each additional 4,000 square feet of floor area, one additional one large species tree or two small species trees shall be required. However, no less than one *large species tree (Sec. 4C.4.4.C.3.a.i.a.)* or two *small species trees (Sec. 4C.4.4.C.3.a.i.b.)* shall be planted on every lot.
2. One large species tree or two small species trees shall be planted for each 500 square feet of total required on-site planting area.
3. One small tree planted in a pedestrian amenity space or public amenity space is permitted in lieu of two small trees. One large tree planted in a pedestrian amenity space or public amenity space is permitted in lieu of large trees.
4. Required trees shall be planted either on-site, in a common area accessible to multiple lots from a shared pedestrian accessway, or in the abutting parkway. Trees planted in the parkway require approval from the Board of Public Works or its designee per *LAMC Sec. 63.169 (Permit Required to Plant Streets)*.
5. When calculating the total number of required trees results in the requirement of a fraction of a tree, any fraction up to and including one-half may be disregarded and any fraction over one-half will require one additional tree.
6. Trees provided to comply with other standards, including *Sec. 4C.4.4. (Parking Lot Design)*, *Sec. 4C.6.4. (Planting Areas)*, *Div. 4C.8. (Screening)*, *Sec. 3C.4.2.E.2. (Ground Story Inactive Wall Treatment Options)*, *Sec. 3C.4.2.E.3. (Foundation Inactive Wall Treatment Options)*, and *Sec.*

8.3.2.A.3. (*Freeway Screening*), may also be counted toward compliance with required trees standards. Additional trees beyond the minimum number required to comply with this section, *required trees* (Sec. 4C.6.2.), may be required to comply with other standards.

7. All required trees shall be planted in accordance with the plant design and installation standards outlined in Sec. 4C.6.4. (*Plant Design & Installation*).

D. **Measurements**

1. For measuring floor area see Sec. 14.1.7 (*Floor Area*).
2. For large tree measurements see Sec. 4C.4.4.C.3 (*Tree Types*).
3. For small tree measurements see Sec. 4C.4.4.C.3 (*Tree Types*).
4. For measurement of caliper see Sec. 4C.4.4.D.10. (*Caliper*).
5. For measurement of container size see Sec. 4C.4.4.D.9. (*Container Size*).

E. **Relief**

1. An alternative to tree planting standards may be requested in accordance with Sec. 13B.5.1 (*Alternative Compliance*).
2. A Director's Determination may be requested to plant a required tree off-site on private property (with prior approval of the property owner) or along public streets (with the prior approval of the Board of Public Works or its designee) within one mile of the lot of the project, or pay an in-lieu fee in accordance with LAMC Sec. 62.177 (*Establishment of Tree Replacement and Planting In-Lieu Fee*) instead of planting a required tree. In order to approve the Director's Determination, the Director of Planning shall make the supplemental finding that required trees cannot feasibly be planted on-site or in the abutting parkway.
3. A deviation from any tree requirement standard may be allowed as a variance in accordance with Sec. 13B.5.3 (*Variance*).

SEC. 4C.6.3. **STREETSCAPE**

[RESERVED]

SEC. 4C.6.4. **PLANT DESIGN & INSTALLATION**

A. **Intent**

To provide the necessary elements to support a healthy urban ecological system.

B. **Applicability**

1. All plants shall comply with plant design and installation standards unless otherwise specified.
2. Where standards are specified as applying only to required plants, these standards do not apply to plants which are not required by this Zoning Code (Chapter 1A).

C. **Standards**

1. **General**

- a. No invasive species may be planted in the city of Los Angeles. Any plant listed by the California Invasive Plant Inventory as an invasive or watch plant (including the ratings of "limited", "moderate", "high" or "watch") is considered an invasive species. (<https://www.cal-ipc.org/plants/inventory/>)
- b. Plants shall not interfere with visibility at intersections and driveways per *LAMC Sec. 62.200 (Street Intersections - Obstructions to Visibility)*.
- c. No plant identified by the Los Angeles Fire Department as a prohibited flammable plant species is allowed in a Very High Fire Severity Hazard Zone, as established in *LAMC Sec. 57.4908.1 (Very High Fire Severity Zone Established)*.
- d. No artificial plants, trees, or other plants may be installed as required planting.
- e. Required planting located on a lot identified as being within a targeted planting area established by the *Targeted Planting Map (Sec. 1.4.5.)* shall meet the requirements outlined in the targeted planting list for the applicable targeted planting area.
- f. Projects with planting areas may be subject to water efficiency standards according to *LAMC Sec. 99.04.304 (Outdoor Water Use)* and *LAMC Sec. 99.05.304 (Outdoor Water Use)*.
- g. Projects with planting areas may be subject to *LAMC Sec. 64.72 (Stormwater and Urban Runoff Pollution Control Measures for Development Planning and Construction Activities)*.

2. Planting Areas

An area on a lot designated and designed for plants.

a. General

- i. Area that includes structures, foundation walls, footings or flatwork shall not count toward any planting area requirement with the following exceptions:
 - a) Planters located within 10 feet of a building that are used to meet LAMC Sec. 64.72 (*Stormwater and Urban Runoff Pollution Control Measures for Development Planning and Construction Activities*) may count toward required planting area.
 - b) Planters located on or above a structure (examples include: roofs, terraces, bridges, balconies, and above or below ground parking structures) may count toward required planting area.
- ii. Where planters are allowed to count toward planting area (See Sec. 4C.6.4.C.2.a.i.), planters shall not be more than 4 feet in height, measured from finished grade.
- iii. Where planters are allowed to count toward planting area (See Sec. 4C.6.4.C.2.a.i.), planters located within 5 feet of the public right-of-way, and located entirely below the top of the ground story, shall not have facing the public right-of-way.
- iv. Planting areas shall include an automatic irrigation system in compliance with LAMC Sec. 99.04.304 (*Outdoor Water Use*).
- v. Planting areas shall have no horizontal dimension less than 3 feet.
- vi. Planting areas shall have a minimum plant coverage of 75 percent.
- vii. All plants required to meet the minimum plant coverage standard shall meet the applicable plant type planting specification standards in Sec. 4C.6.4.C.3. (*Plant Type*). When rooftop planting area standards (Sec. 4C.6.4.C.2.b.) apply and conflict with the plant type planting specifications, rooftop planting area standards supersede.
- viii. Planting areas shall include at least the minimum number of trees as specified in Sec. 4C.6.2.C.3. (*Standards*).

b. Rooftop Planting Areas

Plants provided on or over a built structure, including but not limited to, a roof, a bridge, a balcony or a parking structure, shall comply with the following standards:

- i. Where rooftop planting area standards conflict with plant type planting hole standards (Sec. 4C.6.4.C.3.), rooftop planting area standards supersede.

- Plants -

ii. Minimum soil depth or soil volume for required plants, is as follows:

TREES			OTHER PLANTS	
Height at Maturity	Soil Volume (min)	Soil Depth (min)	Height at Maturity	Soil Depth (min)
15' to 19'	220 ft ³	36"	<5.9"	12"
20' to 24'	400 ft ³	36"	6" to 11"	18"
25' to 29'	620 ft ³	42"	1' to 7'	24"
30' to 34'	900 ft ³	42"	8' to 14'	30"
35' to 39'	1,200 ft ³	42"	15' to 24'	36"
40' or more	1,600 ft ³	48"	25' or more	42"

iii. All large species trees shall be setback from the edge of the roof a minimum of two-thirds the mature height of the tree measured perpendicularly from the edge of the roof to the center of the tree trunk. The required setback may be reduced by an amount equivalent to the height of a guard rail or wall that is provided along the perimeter of the roof edge. The guard rail or wall height is measured vertically from the top of the roof to the topmost point of the wall or guardrail.

iv. All rooftop gardens and landscapes, occupied or unoccupied, shall comply with *LAMC Sec. 57.317 (Rooftop Gardens and Landscaped Roofs)*.

3. Plant Type

a. Trees

i. General

- a) Palms and bamboo do not count as required trees, with the exception of existing palm trees located on a lot identified as being within a targeted planting area established by the Targeted Planting Map (Sec. 1.4.5.). In these targeted planting areas, existing palms may count as a required tree provided that the specific palm tree species meets the requirements outlined in the targeted planting list for the applicable targeted planting area.
- b) Existing trees count toward the minimum tree requirement based on tree type (large species or small species) in accordance with Sec. 4C.6.4.C.3.a. (*Tree Types*), provided each tree is healthy and has a minimum 1 inch caliper, and meets all other applicable standards. An existing significant tree is permitted in lieu of two large species trees or four small species trees.

ii. Tree Types

- a) Large species tree shall have a minimum height of 30 feet at maturity.
- b) Small species tree shall have a height at maturity between 15 and 30 feet.

iii. Planting Specifications

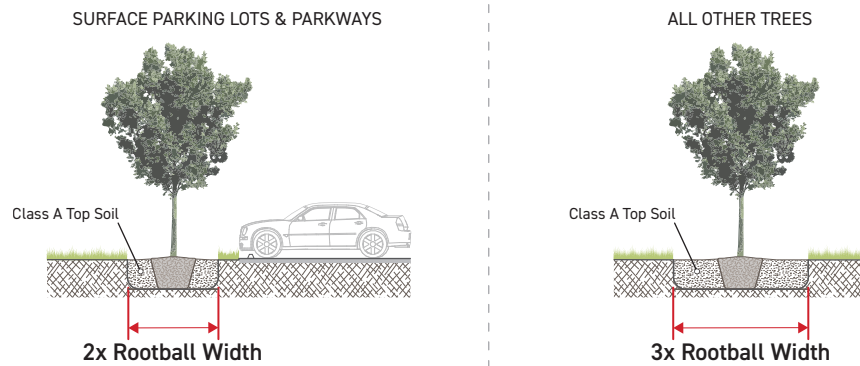

All trees that are provided in order to comply with a standard in this Zoning Code (Chapter 1A) and their planting holes shall meet the following standards:

- a) Located within in a planting area meeting *Sec. 4C.6.4.C.2 (Planting Areas)*.
- b) For trees located in surface parking lots and parkways, planting holes shall be a minimum width of 2 times the width of the rootball
- c) For all other trees, planting holes shall be a minimum width of 3 times the width of the rootball.
- d) Planting holes shall be no deeper than the height of the rootball.
- e) Planting hole shall be backfilled with class A top soil or native variety.
- f) Backfill soil shall be compacted to no more than 70%.
- g) Soil beneath the rootball shall be compacted to at least 90%.
- h) No other plants may be planted within 2 feet of a tree, measured from the center of the tree trunk.
- i) All required trees, shall have a minimum 15 gallon container size and a minimum caliper of 1 inch at the time of planting or as specified by *ASNS (American Standard for Nursery Stock)*.

b. Screening Plants

i. General

- a) Required screening plants shall be perennial including, shrubs, vines, succulents, grasses and ferns.
- b) Required screening plants shall have a minimum height at maturity of 3 feet.

ii. **Planting Specifications**

All screening plants and their planting holes provided to meet a screening requirement shall meet the following standards:

- a) Located within in a planting area meeting *Sec. 4C.6.4.C.2 (Planting Areas)*.
- b) Planting holes shall have a minimum width of 2 times the width of the rootball.
- c) Planting holes shall be no deeper than the height of the rootball.
- d) Planting holes shall be backfilled with Class A top soil or native variety.

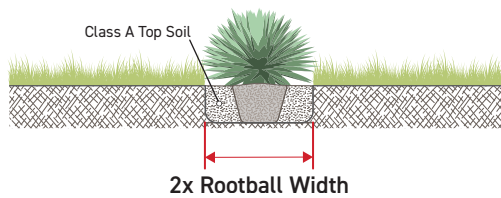

- e) Required screening plants shall have a minimum height of 18 inches at time of planting.

c. **Groundcover & Turf Plants**

Turf plants such as sodded or seeded grass areas provided to meet a planting requirement shall meet the following standards:

- i. Located within in a planting area meeting *Sec. 4C.6.4.C.2 (Planting Areas)*.
- ii. Minimum top soil depth of 6 inches.
- iii. Top soil shall be Class A top soil or native variety.

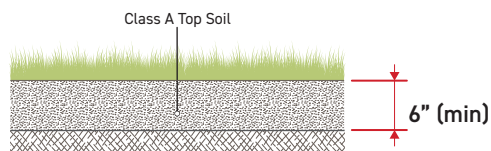

d. **Hedges**

i. **General**

- a) Hedges include all shrubs planted closer than 1/2 of their height at maturity from another shrub or tree and all trees planted closer than 1/2 of their canopy diameter at maturity from another tree.
- b) Trees planted at least 3 feet apart having no branches a minimum of six feet from surrounding grade are not considered a hedge and are not regulated by maximum hedge standards.

ii. Planting Specifications

Shrubs and their planting holes provided as part of a hedge shall meet the following standards:

- a) Located within in a planting area meeting *Sec. 4C.6.4.C.2 (Planting Areas)*.
- b) Planting holes shall have a minimum width of 2 times the width of the rootball.
- c) Planting holes shall be no deeper than the height of the rootball.
- d) Planting holes shall be backfilled with Class A top soil or native variety.

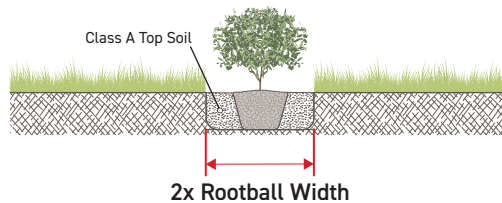

e. Living Walls

Living walls provided to meet a standard shall meet the following standards:

- i. Permanently attached to the exterior of a building or structure.
- ii. Automatic irrigation system permanently integrated into the assembly in compliance with *LAMC Sec 99.04.304 (Outdoor Water Use)*.
- iii. Growing medium shall be permanently integrated into the assembly while retaining the ability to remove, replace and maintain the plants and growing medium.
- iv. Minimum soil depth of 4 inches of Class A top soil or native variety
- v. Minimum 75 percent plant coverage at maturity, measured vertically.
- vi. For living walls adjacent to the public right-of-way, plants shall be maintained so as not to obstruct the public right-of-way.

f. All Other Plants

All plants, other than living walls, hedges, groundcover and turf plants, screening plants and trees provided to meet a planting requirement shall meet the following standards:

- i. Located within in a planting area meeting *Sec. 4C.4.4.C.2 (Planting Areas)*.
- ii. Planting holes shall have a minimum width of 2 times the width of the rootball.
- iii. Planting holes shall be no deeper than the height of the rootball.
- iv. Planting holes shall be backfilled with Class A top soil or native variety.

4. Maintenance

- a. All required plants shall be maintained in good and healthy condition.
- b. All required plants shall be allowed to reach and be maintained at no less than the anticipated spread at maturity or canopy diameter and the anticipated height at maturity.
- c. Landscape and screening areas shall be kept free of weeds and trash.
- d. "Topping," defined as removal of more than 1/3 of the leaves and branches of a tree as measured from the lowest branch on the trunk of the tree to the top of the tree, is prohibited, except as required by a City department, utility, or other government agency.

D. Measurement

1. Planting Area Width

Planting area width is measured as the narrowest horizontal dimension from one edge of an area complying with *Sec. 4C.4.4.C.2 (Planting Areas)* to the opposite edge.

2. Plant Coverage

Plant coverage is measured as the cumulative area of a planting area covered by plants divided by the total planting area.

- a. Trees count as plant coverage only for the portion of a planting area within 2 feet of a tree, measured as a circle, centered on the trunk of the tree, with a radius of 2 feet.
- b. All other plants count as plant coverage for 70% of the plant's anticipated *canopy diameter* or *spread at maturity (Sec. 4C.4.4.D.7.)*.

3. Canopy Diameter, Spread, and Height at Maturity

Canopy diameter at maturity, spread at maturity and height at maturity shall be specified in *Landscape Plants for California Gardens*, or other locally calibrated and professionally recognized source.

4. Soil Depth

Soil depth is measured as the shortest vertical dimension of growing medium provided, for all portions of a planting area.

5. Soil Volume

Soil volume is measured as the total volume of growing medium provided. Drainage layers and other elements located within a container or planter that are not growing medium are not included in the calculation of soil volume.

6. Rootball Depth

Depth of the rootball is measured from the root flare to the bottom of the root mass or bottom of the container.

7. Rootball Width

Width of the rootball is measured as the shortest horizontal dimension of the root mass or container from one end to the opposite end.

8. Height at Planting

- a. Height at planting is measured from the root flare.
- b. For evergreens, height at planting is measured vertically to the midpoint of the leader between the uppermost whorl (branch) and the top of the leader.
- c. For deciduous shrubs, height at planting is measured vertically to the top of the shortest of all canes.
- d. For all other plants, height at planting is measured vertically to the highest point of the plant.

9. Container Size

- a. Container Size is measured in accordance with the American Standard for Nursery Stock (ASNS).
- b. When a minimum container size is indicated by a standard, all equivalent or greater container sizes are also requested in accordance with ASNS Container class volume ranges.

10. Caliper

- a. For fruit trees, small fruits, understock and seedling trees and shrubs, caliper measurement shall be taken at the root collar or at the other points expressly described in the applicable Sections of the American Standard for Nursery Stock.
- b. Caliper for trees with multiple stems is measured as one-half the sum of the calipers of the three largest trunks.
- c. For all other plants, caliper measurement shall be taken six inches above the root collar.

11. Height at Maturity

- a. Height at maturity is measured from the root flare.
- b. For evergreens, height at maturity is measured vertically to the midpoint of the leader between the uppermost whorl (branch) and the top of the leader.
- c. For deciduous shrubs, height at maturity is measured vertically to the top of the shortest of all canes.
- d. For all other plants, height at maturity is measured vertically to the highest point of the plant.

E. Relief

1. An alternative to plant design and installation standards may be requested in accordance with *Sec. 13B.5.1 (Alternative Compliance)*.
2. A deviation from any plant design and installation dimensional standard of up to 10% may be requested in accordance with *Sec. 13B.5.2 (Adjustment)*.
3. A deviation from any plant design and installation standard may be allowed as a variance in accordance with *Sec. 13B.5.3 (Variance)*.

DIV. 4C.7. **FENCES & WALLS**

SEC. 4C.7.1. **FRONTAGE YARD FENCES & WALLS**

For fences, walls, and hedges allowed in a frontage yard, see *Sec. 3C.3.2. (Frontage Yard Fences & Walls)*.

SEC. 4C.7.2. **SIDE/REAR YARD FENCES & WALLS**

A. **Intent**

To provide security and privacy for private ground story uses facing side and rear yards in a manner appropriate to context.

B. **Applicability**

All walls, fences and hedges located in a rear or side yard. See *Sec. 14.1.15. (Yards)*, excluding retaining walls. Retaining walls shall meet the standards of *Sec. 4C.10.2. (Retaining Walls)*.

C. **Standards**

1. Where a required *frontage screen (Sec. 4C.8.1.)* or *transition screen (Sec. 4C.8.2.)* includes a wall or fence with a minimum height that exceeds the maximum height established by *Sec 4C.7.2.C.2.* below, the maximum fence and wall height shall be 2 feet greater than the minimum fence and wall height specified by the required frontage or transition screen.
2. Side and rear yard fences, walls and hedges shall be no taller than specified in the following table:

SIDE/REAR YARD FENCE & WALL HEIGHT	
Use Districts	Height (Max)
Open Space	8'
Agricultural	8'
Residential	8'
Residential Mixed	8'
Commercial Mixed	8'
Commercial	None*
Industrial Mixed	8'
Industrial	None*
Public	None*

* A *class 1 conditional use permit (Sec. 13B.2.1.)* is required for fences and walls exceeding 8 feet in height or the maximum height established by *Sec 4C.7.2.C.1* above where they are adjacent to a lot zoned with a Use District other than a Commercial, Industrial, or Public Use District.

3. All fences and walls provided shall comply with *Sec. 4C.7.3 (Fence/Wall Design and Installation)*.

4. All hedges provided shall comply with *Sec. 4C.4.4. (Plant Design & Installation)*.

D. Measurement

1. Where the difference in finished grade on either side of a fence or wall is less than 2 feet, height is measured from finished grade at the base of the wall or fence on the side with the highest finished grade. Finished grade on either side of a fence or wall is measured as the highest and lowest finished grade within 3 feet of the fence or wall.

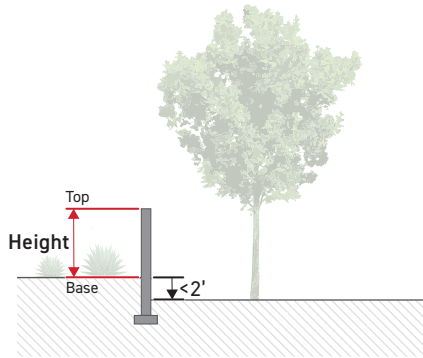

2. Where the difference in finished grade on either side of a fence or wall is 2 feet or greater, height is measured from the top of the wall or fence to the average of the finished grades on either side of the fence or wall. Finished grade on either side of a fence or wall is measured as the highest and lowest finished grade within 3 feet of the fence or wall.

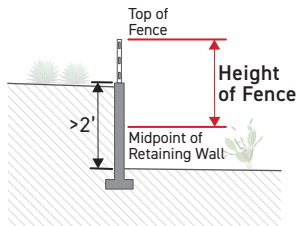

3. Fences and walls located in a rear yard or side yard adjacent to an alley are measured vertically from the nearest surface of the adjacent alley, to the topmost point of the wall or fence.

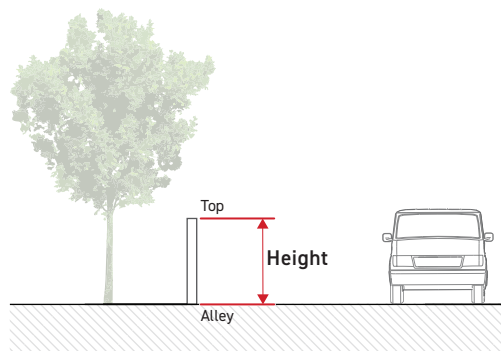

E. Relief

1. An alternative to side/rear yard fences and walls standards may be requested in accordance with *Sec. 13B.5.1 (Alternative Compliance)*.
2. A deviation from any side/rear yard fences and walls dimensional standard of up to 10% may be requested in accordance with *Sec. 13B.5.2 (Adjustment)*.
3. A deviation from any side/rear yard fences and walls standard may be allowed as a variance in accordance with *Sec. 13B.5.3 (Variance)*.

SEC. 4C.7.3. **FENCE/WALL DESIGN & INSTALLATION**

A. **Intent**

To allow for needed security and privacy while preventing looming, and ensuring adequate access to light and air for abutting properties.

B. **Applicability**

All fences, walls and hedges provided on a lot shall comply with fence/wall design and installation standards unless otherwise specified.

C. **Standards**

1. **General**

- a. No wall or fence may be constructed of tires, junk, leaves or other discarded materials.
- b. Fences and walls shall not interfere with visibility at intersections and driveways see *LAMC Sec. 62.200 (Street Intersections - Obstructions to Visibility)*.

2. **Maintenance**

Walls and fences shall be maintained in good repair and shall be kept vertical, structurally sound and protected from deterioration.

D. **Measurement**

[Reserved]

E. **Relief**

1. An alternative to fence/wall design and installation standards may be requested in accordance with *Sec. 13B.5.1 (Alternative Compliance)*.
2. A deviation from any fence/wall design and installation dimensional standard of up to 10% may be requested in accordance with *Sec. 13B.5.2 (Adjustment)*.
3. A deviation from any fence/wall design and installation standard may be allowed as a variance in accordance with *Sec. 13B.5.3 (Variance)*.

DIV. 4C.8. **SCREENING**

SEC. 4C.8.1. **FRONTAGE SCREENS**

A device or combination of elements along a frontage lot line that conceals, obstructs or protects the public realm from adjacent uses, *activities*, or *site elements*.

A. **Intent**

To mitigate negative impacts from subject uses, *activities*, or *site elements* with significant impacts on the public realm, promoting visual interest and increasing comfort for users of the public realm.

B. **Applicability**

Frontage screen standards are applicable when required by the applied *Use District (Part 5B)*, *Sec. 4C.2.2. (Motor Vehicle Use Area Design)*, *Sec. 4C.2.2.C.2. (Drive-Through Facilities)*, *Sec. 4C.2.2.C.3. (Freight Loading Areas)*, *Sec. 4C.4.4. (Parking Lot Design)* or *Sec. 4C.4.4. (Parking Structure Design)*.

C. **Standards**

1. **General**

- a. Required frontage screens shall be located between the use, area, or site element subject to screening requirements and all frontage lot lines. Any wall and planting area required by the frontage screen type shall be continuous with the following exceptions:
 - i. Openings in a required frontage screen accommodating pedestrian accessways are allowed for a width no greater than 8 feet in width for each individual pedestrian accessway. Where an opening in the frontage screen accommodates both pedestrian and automobile access, the maximum allowable opening width is 8 feet greater than the maximum allowed driveway width.
 - ii. Openings in a required frontage screen accommodating automobile access are allowed for a width no greater than the maximum allowed driveway width allowed by the applied *Development Standards District (Part 4B)*.
 - iii. For portions of frontage lot lines where a building of no less than 10 feet in height is located between the frontage lot line and the use, area, or site element subject to frontage screening requirements, no wall is required as part of the frontage screen, provided that the building is contiguous with the required wall.
- b. Required frontage screens including their sub-grade elements, such as footings or foundations, shall be located entirely on-site.
- c. Where there are overlapping frontage screen requirements, the screen type with the highest minimum fence or wall shall apply. Where none of the required screen types have a fence or wall requirement, the screen type with the widest required planting area shall apply.

- d. Where a required frontage screen includes a wall, the wall may only be located in the frontage yard if the wall complies with the allowed frontage yard fence and wall standards specified by the applied *Frontage District (Part 3B)*. Uses, activities, or site elements subject to frontage screening requirements shall not be located in a frontage yard if the required minimum wall height specified by the frontage screen exceeds the maximum height of allowed frontage yard fences and walls as specified by the *Frontage District (Part 3B)*.
- e. Where a required frontage screen includes a wall with a minimum height that exceeds the maximum height allowed in the rear or side yard (See Sec 4C.7.2.C.2.), the maximum wall height shall be 2 feet greater than the minimum wall height specified by the frontage screen.
- f. All walls provided in a frontage screen shall comply with Sec. 4C.7.3 (*Fence/Wall Design and Installation*).
- g. All plants provided in a frontage screen shall comply with Sec. 4C.4.4. (*Plant Design and Installation*).
- h. Maximum wall and fence height is regulated by Sec. 4C.7.1. (*Frontage Yard Fences & Walls*) and Sec. 4C.7.2. (*Side/Rear Yard Fences & Walls*).
- i. Walls provided to meet the standards of Frontage Screen 4 and 5 shall not include chain link, barbed wire, or concertina.

2. Frontage Screen Types

Packages of standards for required frontage screen

a. F-Screen 1

Intended for screening motor vehicle use areas that face a frontage lot line, including vehicle display areas.

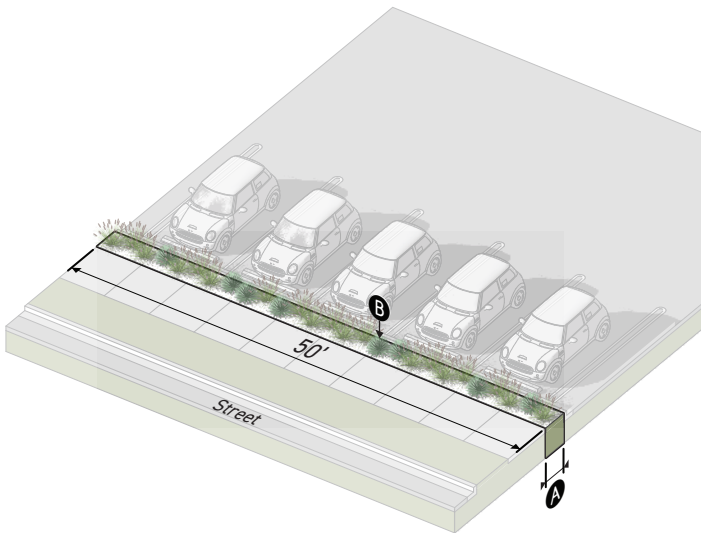

PLANTING AREA		Sec. 4C.8.1.D.
A	Width (min)	3'
B	Screening Plants (min per 50')	20
WALLS		Sec. 4C.8.1.D.
	Height	n/a
	Opacity	n/a

b. F-Screen 2

Intended for screening motor vehicle areas including drive-through lanes, drive aisles, maneuvering areas and fire lanes that face a frontage lot line.

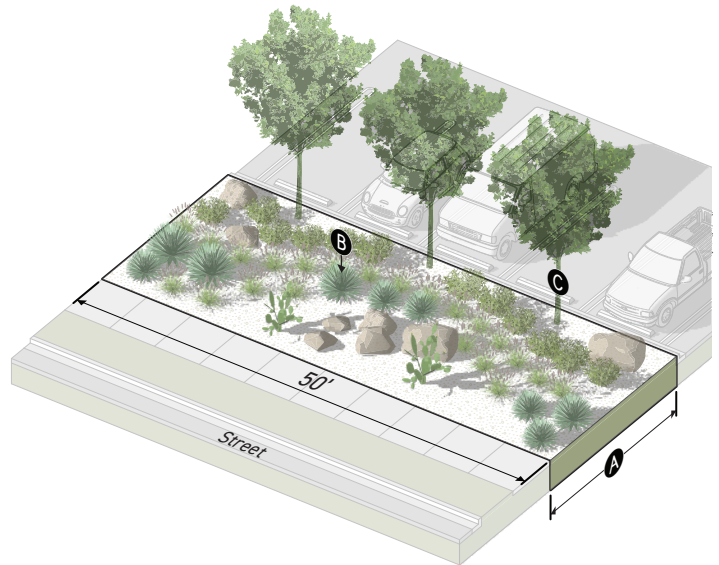

PLANTING AREA		Sec. 4C.8.1.D.
A	Width (min)	15'
B	Screening Plants (min per 50')	45
C	Large Species Trees (min per 50')	3
WALLS		Sec. 4C.8.1.D.
	Height	n/a
	Opacity	n/a

c. F-Screen 3

Intended for screening motor vehicle areas including drive-through lanes, drive aisles, maneuvering areas and fire lanes that face a frontage lot line.

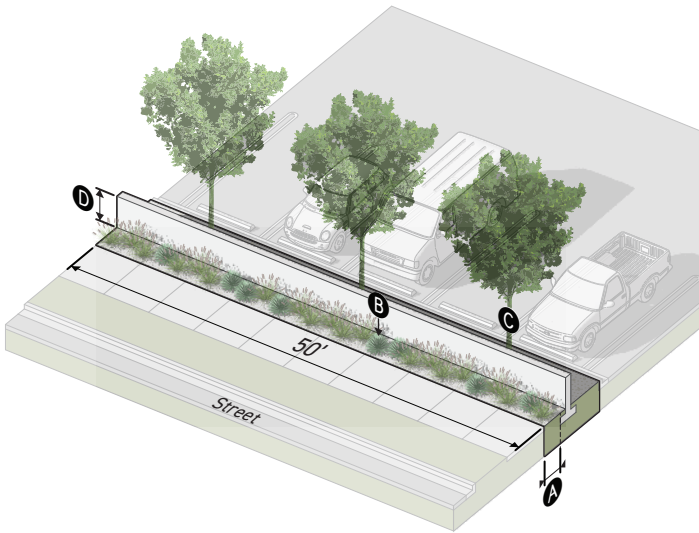

d. F-Screen 4

Intended for screening outdoor areas associated with moderate-impact uses that face a frontage lot line.

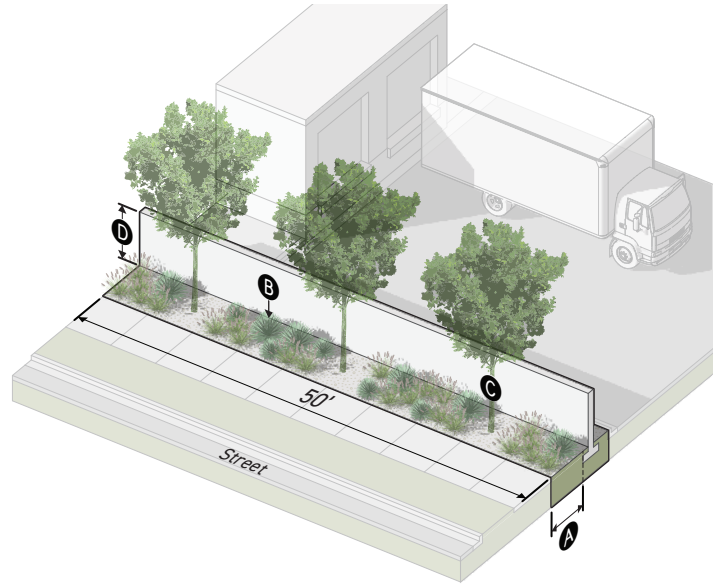

PLANTING AREA		Sec. 4C.8.1.D.
A	Width (min)*	3'
B	Screening Plants (min per 50')	20
C	Large Species Trees (min per 50')*	3
WALLS		Sec. 4C.8.1.D.
D	Height (min)	3.5'
Opacity		
Below 3.5' (min)		90%
3.5' and above (max)		50%

PLANTING AREA		Sec. 4C.8.1.D.
A	Width (min)	5'
B	Screening Plants (min per 50')	30
C	Large Species Trees (min per 50')	3
WALLS		Sec. 4C.8.1.D.
D	Height (min)	6'
Opacity		
Below 6' (min)		100%
6' and above (max)		50%

* Additional planting area may be required to accommodate large species trees.

e. F-Screen 5

Intended for screening outdoor areas associated with high-impact uses that face a frontage lot line.

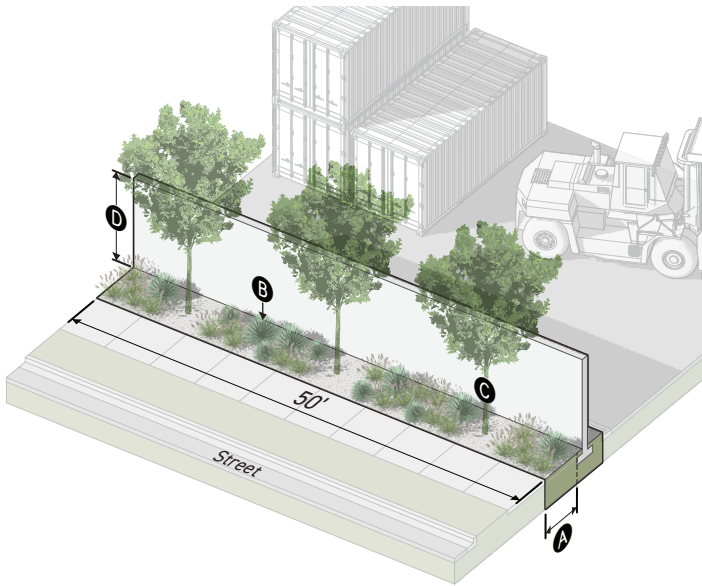

PLANTING AREA	<i>Sec. 4C.8.1.D.</i>
A Width (min)	5'
B Screening Plants (min per 50')	30
C Large Species Trees (min per 50')	3
WALLS	<i>Sec. 4C.8.1.D.</i>
D Height (min)	10'
Opacity	
Below 10' (min)	100%
10' and above (max)	100%

D. Measurement

1. Planting Area

a. Width

For measuring planting area width see *Sec. 4C.4.4.D.1 (Planting Area Width)*.

b. Frequency

For measuring frequency, for example 5 per 50', see *Sec. 14.1.8. (Frequency)*.

c. Screening Plants

For screening plant standards see *Sec. 4C.4.4.C.3.b. (Screening Plants)*.

d. Large Species Trees

For large tree standards see *Sec. 4C.4.4.C.3.a.i (Tree Type- Large Tree)*.

2. Walls

a. Height

Frontage screen wall height is measured for the portion of the wall constructed of concrete or masonry that has a minimum thickness of 8 inches and meets the minimum opacity specified by the *Frontage screen type (4C.8.1.C.2.)*. For measuring wall height in a rear yard or side yard, see *Sec. 4C.7.2.D. (Fence and Wall Height)*. For measuring wall height in a frontage yard see *Sec. 3C.3.2.D.2 (Fence and Wall Height)*.

b. Opacity

For measuring opacity see *Sec. 14.1.13. (Opacity %)*.

E. Relief

1. An alternative to frontage screen standards may be requested in accordance with *Sec. 13B.5.1 (Alternative Compliance)*.
2. A deviation from any frontage screen dimensional standard of up to 10% may be requested in accordance with *Sec. 13B.5.2 (Adjustment)*.
3. A deviation from any frontage screen standard may be allowed as a variance in accordance with *Sec. 13B.5.3 (Variance)*.

SEC. 4C.8.2. **TRANSITION SCREENS**

A device or combination of elements along a common lot line that conceals, obstructs or protects abutting lots from impactful uses, activities, or site elements.

A. **Intent**

To mitigate negative impacts from subject uses, activities, or site elements on adjacent uses, promoting visual interest and increasing comfort for users of the subject lot, the public realm and adjacent lots.

B. **Applicability**

Transition screen standards are applicable when required by the applied *Use District (Part 5B)*, *Sec. 4C.2.2. (Motor Vehicle Use Area Design)*, *Sec. 4C.2.2.C.2. (Drive-Through Facilities)*, *Sec. 4C.2.2.C.3. (Freight Loading Areas)*, *Sec. 4C.4.4. (Parking Lot Design)*, *Sec. 4C.4.4. (Parking Structure Design)*, *Sec. 4C.8.2.C.2.a. (Freeway Screening)*, or *Sec. 8.3.2.A.3. (Freeway Screening)*.

C. **Standards**

1. **General**

- a. Required transition screens shall be located between the use, area, or site element subject to screening requirements and all common lot lines. Any walls and planting areas required by the transition screen type shall be continuous with the following exceptions:
 - i. Openings in a required transition screen accommodating pedestrian accessways are allowed for a width no greater than 6 feet in width for each individual pedestrian accessway.
 - ii. For portions of common lot lines where a building of no less than 10 feet in height is located between the common lot line and the use, area, or site element subject to transition screen requirements, no wall is required as part of the transition screen, provided that the building is contiguous with the required wall.
- b. Required transition screens including their sub-grade elements, such as footings or foundation, shall be located entirely on-site.
- c. Where there are overlapping transition screen requirements, the screen with the highest minimum wall shall apply. Where none of the required screen types have a fence or wall requirement, the screen type with the widest required planting area shall apply.
- d. Where a required transition screen includes a wall, the wall may only be located in the frontage yard if the wall complies with the allowed frontage yard fence and wall standards specified by the applied *Frontage District (Part 3B)*. Uses, activities, or site elements subject to screening requirements shall not be located in a frontage yard if the required minimum wall height specified by the transition screen exceeds the maximum height of allowed frontage yard fences and walls as specified by the *Frontage District (Part 3B)*.

- e. Where a required transition screen includes a wall with a minimum height that exceeds the maximum height allowed in the rear or side yard (See Sec 4C.7.2.C.2.), the maximum wall height shall be 2 feet greater than the minimum wall height specified by the transition screen.
- f. All walls provided in a transition screen shall comply with Sec. 4C.7.3 (*Fence/Wall Design and Installation*).
- g. All plants provided in a transition screen shall comply with Sec. 4C.4.4. (*Plant Design and Installation*).
- h. Maximum wall and fence height is regulated by Sec. 4C.7.1. (*Frontage Yard Fences & Walls*) and Sec. 4C.7.2. (*Side/Rear Yard Fences & Walls*).
- i. Walls provided to meet the standards of Frontage Screen 4 and 5 shall not include chain link, barbed wire, or concertina.

2. **Freeway Screening**

- a. Lots abutting a *Freeway (FWY) Special District* (Sec. 8.3.2.) shall provide a *T-3 transition screen* (Sec. 4C.8.2.C.2.c.) for the entire length of any lot line abutting a *Freeway (FWY) Special District*.
- b. In *Freeway (FWY) Special Districts* (Sec. 8.3.2.), *T-3 transition screens* (Sec. 4C.8.2.C.2.c.) shall be provided as according to Sec. 8.3.2.A.3. (*Freeway Screening*).

3. Transition Screen Types

a. T-Screen 1

Intended for screening moderate-impact uses from abutting lower-intensity uses.

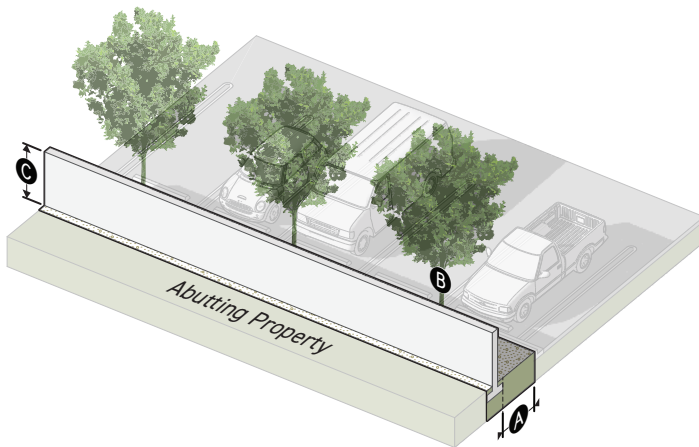

PLANTING AREA		Sec. 4C.8.2.D.
A	Width (min)	5'
B	Large Species Trees (min per 50')	3
WALLS		Sec. 4C.8.2.D.
C	Height (min)	6'
	Opacity	
	Below 6' (min)	100%
	6' and above (max)	50%

b. T-Screen 2

Intended for screening high-impact uses from lower-intensity abutting uses.

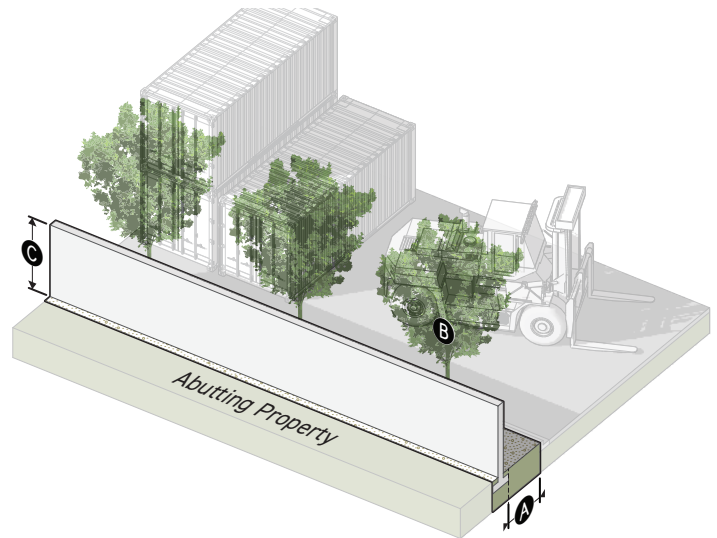

PLANTING AREA		Sec. 4C.8.2.D.
A	Width (min)	5'
B	Large Species Trees (min per 50')	3
WALLS		Sec. 4C.8.2.D.
C	Height (min)	10'
	Opacity	
	Below 10' (min)	100%
	10' and above (max)	100%

c. T-Screen 3

Intended for screening uses from adjacent sources of noise pollution and particulate air pollution such as freeways.

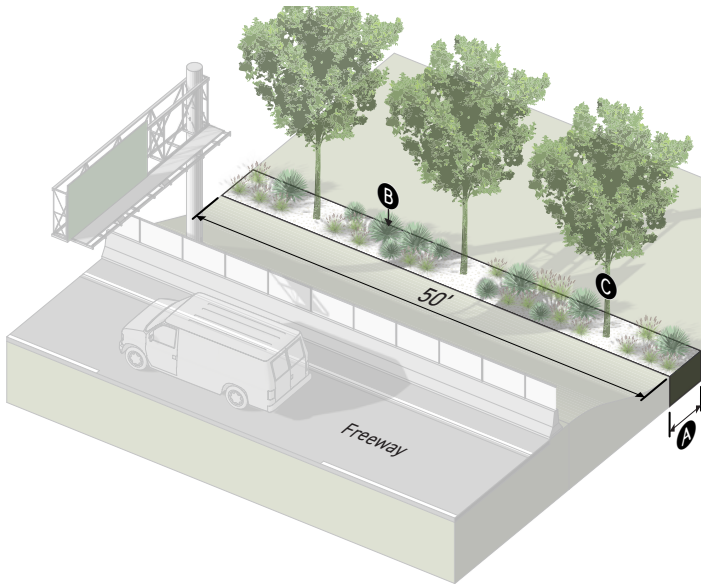

PLANTING AREA	Sec. 4C.8.2.D.
A Width (min)	5'
B Screening Plants (min per 50')	30
C Large Species Trees (min per 50')	3
WALLS	Sec. 4C.8.2.D.
Height (min)	None

D. Measurement

1. Planting Area

a. Width

For measuring planting area width see *Sec. 4C.4.4.D.1 (Planting Area Width)*.

b. Frequency

For measuring frequency, for example 5 per 50', see *Sec. 14.1.8. (Frequency)*.

c. Screening Plants

For screening plant standards see *Sec. 4C.4.4.C.3.b. (Screening Plants)*.

d. Large Species Trees

For large tree standards see *Sec. 4C.4.4.C.3.a.i (Tree Type- Large Species Tree)*.

2. Walls

a. Height

Transition screen wall height is measured for the portion of the wall constructed of concrete or masonry that has a minimum thickness of 8 inches and meets the minimum opacity specified by the *transition screen type (4C.8.2.C.3)*. For measuring wall height in a rear yard or side yard, see *Sec. 4C.7.2.D. (Fence and Wall Height)*. For measuring wall height in a frontage yard see *Sec. 3C.3.2.D.2 (Fence and Wall Height)*.

b. Opacity

For measuring opacity see *Sec. 14.1.13. (Opacity %)*.

E. Relief

1. An alternative to transition screen standards may be requested in accordance with *Sec. 13B.5.1 (Alternative Compliance)*.
2. A deviation from any transition screen dimensional standard of up to 10% may be requested in accordance with *Sec. 13B.5.2 (Adjustment)*.
3. A deviation from any transition screen standard may be allowed as a variance in accordance with *Sec. 13B.5.3 (Variance)*.

SEC. 4C.8.3. **OUTDOOR STORAGE**

Material and equipment, new or used, held outside of a building for future use. Outdoor storage includes the storage of vehicles, boats, or airplanes which are inoperable, wrecked, damaged or unlicensed, i.e. not currently licensed by the Department of Motor Vehicles.

A. **Intent**

To ensure outdoor storage areas are designed in a manner that conceals, obstructs or protects abutting lots from impactful activities associated with outdoor storage.

B. **Applicability**

Outdoor storage screening standards are applicable where required by an applicable *Part 5B. Use District*. Outdoor storage screening standards do not apply to outdoor storage use areas where they are permitted by the applied *Use District (Part 5B)* but no outdoor storage screen is specified for the use.

C. **Standards**

1. **Location**

Outdoor storage and its screening enclosure shall not be located in any of the following locations:

- a. In a frontage yard.
- b. Closer to any frontage lot line than the frontage lot line setback listed in outdoor storage screen types.

2. **Screening Enclosure**

- a. Outdoor storage areas shall be screened with the outdoor storage screening type specified by the applicable *Use District (Part 5B)*.
- b. Necessary gates provided in the screening structure shall meet the standards of the specified outdoor storage screening type in addition to the following standards:
 - i. Shall have a height of no less than the minimum required fence or wall height.
 - ii. Where a screening structure is taller than the minimum height, gates may be no more than 1 foot shorter than the height of the wall or fence provided.
 - iii. In no case shall gates exceed the height of the screening structure by more than 1 foot.
- c. No material or equipment shall be stored to a height greater than the height of the enclosing wall or fence.
- d. All provided fences and walls shall comply with *Sec 4C.7.3 (Fence/Wall Design and Installation)*.

3. Outdoor Storage Screening Types

a. S-Screen 1

Applicable as required by *Article 5. (Use)*.

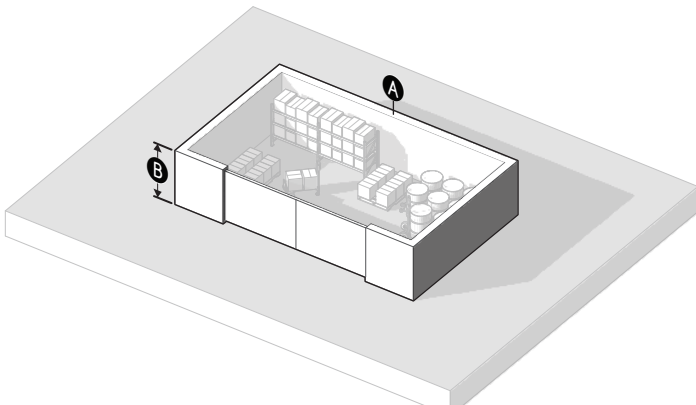

SITING		Sec. 4C.8.3.D.
Frontage lot line setback (min)		60'
Area (max)		3000 SF
FENCES & WALLS		Sec. 4C.8.3.D.
A Enclosure (min)		100%
B Height (min)		6'
Opacity (min)		90%

b. S-Screen 2

Applicable as required by *Article 5. (Use)*.

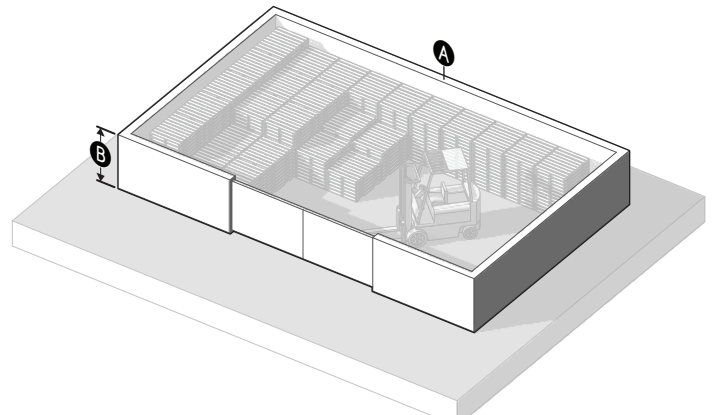

SITING		Sec. 4C.8.3.D.
Frontage lot line setback (min)		n/a
Area (max)		n/a
FENCES & WALLS		Sec. 4C.8.3.D.
A Enclosure (min)		100%
B Height (min)		6'
Opacity (min)		90%

D. Measurement

1. Siting

- a. For frontage yard designation see *Sec. 14.1.20.G. (Frontage Yard)*.
- b. Frontage lot line setbacks are measured perpendicular from all frontage lot lines toward the interior of the lot
- c. For lot line designation see *Sec. 14.1.12. (Lot Line Determination)*.
- d. For measurement of outdoor storage area, the area of an outdoor storage space is measured as all portions of a lot used for outdoor storage uses and enclosed by a screening structure. The area does not include the screening structure.

2. Fences and Walls

- a. For measurement of enclosure see *Sec. 14.1.4. (Enclosure)*.
- b. For measurement of fence or wall height see *Sec. 4C.7.1.D.2. (Fence and Wall Height)*.
- c. For measurement of opacity see *Sec. 14.1.13. (Opacity %)*.

E. Relief

1. An alternative to outdoor storage screening standards may be requested in accordance with *Sec. 13B.5.1 (Alternative Compliance)*.
2. A deviation from any outdoor storage screen type dimensional standard of up to 15% may be requested in accordance with *Sec. 13B.5.2 (Adjustment)*.
3. Deviation from any outdoor storage standard may be allowed as a variance in accordance with *Sec. 13B.5.3 (Variance)*.

DIV. 4C.9. **GRADING & RETAINING WALLS**

SEC. 4C.9.1. **GRADING & HAULING**

[Reserved]

SEC. 4C.9.2. **RETAINING WALLS**

A freestanding continuous structure, as viewed from the top, intended to support earth, which is not attached to a building.

A. **Intent**

To prevent retaining walls which loom over neighboring properties and public right-of-ways in our Hillside Areas and improve the aesthetic quality of large retaining walls.

B. **Applicability**

This Section applies to retaining walls that meet all of the following criteria:

1. Located in an Agricultural or Residential Use District;
2. Located on land designated as a Hillside Area; and
3. Located on a lot developed or to be developed with dwelling units.

C. **Standards**

1. **General**

A maximum of one free-standing vertical or approximately vertical retaining wall may be built on any lot with a maximum height of 12 feet. However, as shown in the diagram below, a maximum of two vertical or approximately vertical walls or portions of a wall can be built if they comply with all of the following standards:

- a. The minimum horizontal distance between the two walls is three feet,
- b. Neither of the two walls exceed a height of 10 feet, and
- c. In no case shall the height of a wall located in a yard exceed the maximum height specified by the frontage yard fence and wall type (Sec. 4C.7.1.C.2.) allowed in the applied Frontage District, except as allowed in Sec. 4C.7.2. (*Side/Rear Yard Fences & Walls*).

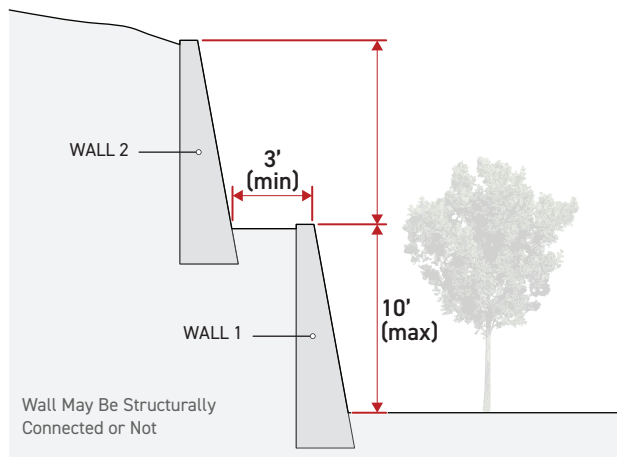

2. **Landscaping**

All retaining walls of 8 feet or greater in height shall be landscaped so as to be completely hidden from view and in accordance with any plant standards in Div 4C.6 (Plants), and fences and wall standards in Div. 4C.7. (Fences and Walls).

D. **Measurement**

The height of retaining walls is measured from the top of the wall to the lower side of the adjacent ground elevation.

E. **Exceptions**

1. **Exception for Public Agency Projects**

This Section does not apply to projects undertaken by a public agency.

2. **Exception for Retaining Walls Required by Building and Safety**

The provisions of this subdivision do not apply to any retaining wall built to comply with an order issued by the Department of Building and Safety to repair an unsafe or substandard condition.

F. **Relief**

The Zoning Administrator may approve retaining walls that exceed the heights or the maximum number allowed in *Sec. 4C.9.2.C. (Standards)* pursuant to *Sec. 13B.2.1. (Class 1 Conditional Use Permit)*.

DIV. 4C.10. **OUTDOOR LIGHTING & GLARE**

SEC. 4C.10.1. **OUTDOOR LIGHTING**

A. **Intent**

Minimize light trespass and provide lighting standards to support a variety of environments.

B. **Applicability**

1. All exterior luminaires and luminaires located within parking structures shall meet the requirements of Section 4C.10.1.C.1 (Light Trespass).
2. Any new exterior luminaire shall meet the requirements of Section 4C.10.1.C.2 (Lighting Quantity).

C. **Standards**

1. **Light Trespass**

- a. Outdoor luminaires that have the ability to be redirected, shall be directed away from adjacent lots to minimize light trespass onto adjacent properties.
- b. No person shall construct, establish, create, or maintain any stationary exterior light source that may cause light trespass onto adjacent properties exceeding the following amounts:
 - i. From any lot onto a lot zoned with a Residential or Residential-Mixed Use District, the maximum allowable light trespass shall be 0.5 foot-candles (5.38 lux).
 - ii. From any lot onto a lot zoned with a non-Residential or non-Residential-Mixed Use District, the maximum allowable light trespass shall be 1 foot-candle (10.76 lux).
- c. The owner of a lot with any existing light source shall bring such light source into compliance with this section upon receipt of written notice from the Department of Building and Safety.

2. **Lighting Quantity**

- a. All parking areas and garages provided for 3 or more dwelling units shall have an average horizontal illuminance of not less than 0.2 footcandles (2.15 lux), measured from the finished surface of the parking area.
- b. Any lot adjacent to a Special River Lot Line according to Sec. 14.1.11.E. (Special Lot Line) must meet the additional standards below:
 - i. All site and building mounted lighting shall be designed such that it produces a maximum initial luminance value no greater than 0.20 horizontal and vertical footcandles (2.15 lux) at the site boundary and no greater than 0.01 horizontal footcandles (0.11 lux) 15 feet beyond the site.

- Outdoor Lighting & Glare -

- ii. All low pressure sodium, high pressure sodium, metal halide, fluorescent, quartz, incandescent greater than 60 watts, mercury vapor, and halogen fixtures shall be fully shielded in such a manner as to not exceed the limitations in Sec. 4C.10.1.C.2.a. above.
- iii. All low pressure sodium, high pressure sodium, metal halide, fluorescent, quartz, incandescent greater than 60 watts, mercury vapor, and halogen lighting shall be in a fully shielded luminaire.

3. Pedestrian-Oriented Lighting

The walking surface of spaces required to install pedestrian-oriented lighting shall be illuminated to the following standards:

- a. A minimum average horizontal illuminance of 0.75 footcandles.
- b. A uniformity ratio of 3:1.
- c. Luminaires shall be mounted no more than 15 feet above the walking surface.

D. Measurement

A footcandle is a unit of illuminance. 1 lumen per square foot is equivalent to 1 footcandle, a measurement typically recorded using a light meter.

E. Relief

A deviation from any lighting standard may be requested as a variance in accordance with Sec. 13B.5.3 (Variance).

SEC. 4C.10.2. **GLARE**

A. Intent

To prevent the generation of high levels of glare and reflected heat resulting in detrimental effects on surrounding properties and the public realm.

B. Applicability

All materials installed on a building facade shall comply with glare standards.

C. Standards

Buildings may not use materials with an external reflectance rating of 30 percent or greater.

D. Measurement

External reflectance values are based on spectrophotometric measurements and energy distribution of solar radiation, and are measured according to the listed specifications for each glass product.

E. Relief

1. An alternative to any glare standards may be requested in accordance with Sec. 13B.5.1 (Alternative Compliance).
2. A deviation from any glare standard may be requested as a variance in accordance with Sec. 13B.5.3 (Variance).

DIV. 4C.11. **SIGNS**

SEC. 4C.11.1. **GENERAL SIGN RULES**

A. **Intent**

The purpose of this Division is to promote public safety and welfare by regulating signs in keeping with the following objectives:

1. That the design, construction, installation, repair and maintenance of signs will not interfere with traffic safety or otherwise endanger public safety.
2. That the regulations will provide reasonable protection to the visual environment by controlling the size, height, spacing and location of signs.
3. That both the public and sign users will benefit from signs having improved legibility, readability and visibility.
4. That consideration will be given to equalizing the opportunity for messages to be displayed.
5. That adequacy of message opportunity will be available to sign users without dominating the visual appearance of the area.
6. That the regulations will conform to judicial decisions, thereby limiting costly litigation and facilitating enforcement of these regulations.

B. **Applicability**

1. All exterior signs, window signs, and sign support structures not located entirely in the public right-of-way shall conform to general sign rules.
2. A sign, having no sign face visible from any public or private right-of-way, that is enclosed by permanent, opaque architectural features on the project site, including building walls, freestanding walls, roofs, or overhangs, is not subject to the requirements of this Division except for the general brightness limitation set forth in *Sec. 4C.11.1.C.3. (Sign Illumination Limitations)*.

C. **Standards**

1. **Ideological, Political, and Non-Commercial Messages**

No provision of this Division prohibits an ideological, political or other noncommercial message on a sign otherwise permitted by this Division.

2. **Sign Height**

No sign may be located at a height that exceeds the building height limit specified by the applicable *Form District (Part 2B)*.

3. **Sign Illumination Limitations**

No sign shall be arranged and illuminated in a manner that will produce a light intensity of greater than 3.0 footcandles above ambient lighting, as measured at the property line. Sign illumination shall also comply with any applicable provision from Sec. 4C.10.1. (Outdoor Lighting).

4. **Maintenance**

a. **Appearance**

Every sign shall be maintained in a clean, safe and good working condition, including the replacement of defective parts, defaced or broken faces, lighting and other acts required for the maintenance of the sign. Display surfaces shall be kept neatly painted or posted at all times.

b. **Debris Removal**

The base of any sign erected on the ground shall be kept clear of weeds, rubbish or other combustible material at all times.

c. **Abandoned Signs**

Ninety days after the cessation of a business activity, service or product, the related signs shall be removed, or the face of the signs removed and replaced with blank panels, or be painted out.

5. **Hazard To Traffic**

a. **Prohibition**

No sign or sign support structure shall be erected, constructed, painted or maintained, and no permit can be issued, if the sign or sign support structure, because of its location, size, nature or type, constitutes a hazard to the safe and efficient operation of vehicles upon a street or a freeway, or creates a condition that endangers the safety of persons or property.

b. **Hazard Referral**

The Department of Building and Safety will refer the following to LADOT for hazard evaluation and determination prior to the issuance of a building permit:

- i. All permit applications for signs that will be visible from and are located within 500 feet of the main traveled roadway of a freeway; and
- ii. All other permit applications and any signs that are determined by the Department of Building and Safety to have a potential for hazard.

c. **Hazard Determination**

LADOT will return to the Department of Building and Safety each application given to it together with a statement of its determination. If LADOT determines that the sign or sign support structure will constitute a hazard, the Department of Building and Safety shall deny the application for permit.

6. **Freeway Exposure**

- a. No person shall erect, construct, install, paint or maintain, and no building or electrical permit can be issued for, any sign or sign support structure within 2,000 feet of a freeway unless the Department of Building and Safety has determined that the sign will not be viewed primarily from a main traveled roadway of a freeway or an on-ramp/off-ramp.
- b. The phrase viewed primarily from means that the message may be seen with reasonable clarity for a greater distance by a person traveling on the main traveled roadway of a freeway or on-ramp/off-ramp than by a person traveling on the street adjacent to the sign.

7. **Sign Permit Priority Status**

- a. To maintain location, area, frontage, or spacing status, signs shall be installed within 6 months of issuance of a building permit and prior to expiration of any permit extension granted by the Department of Building and Safety.
- b. When more than one permit is issued for a sign or signs on a lot and the more recently issued permit or permits cause such sign or signs to violate this Division, the more recently issued permit or permits are invalid and are subject to revocation. Any prior issued permits remain valid provided that such permits were issued in compliance with this Division.

8. **Prohibited Signs**

Signs are prohibited if they:

- a. Contain obscene matters, as defined in *California Penal Code, Section 311*.
- b. Contain or consist of posters, pennants, banners, ribbons, streamers or spinners, except as permitted in *Sec. 4C.11.2 (Temporary Signs)*.
- c. Contain flashing, mechanical and strobe lights in conflict with the provisions of *Chapter VIII., Division B, Section 80.08.4 (Flashing Lights – Interference With Traffic Signals)* and *Chapter 9, Article 3, Section 93.0107 (Distracting, Confusing or Nuisance Lighting Viewed From Public Streets, Highways or Other Public Thoroughfares Used by Vehicular Traffic)*.
- d. Are revolving and where all or any portion rotate at greater than 6 revolutions per minute.
- e. Are tacked, pasted or otherwise temporarily affixed on the walls of buildings, barns, sheds, trees, poles, posts or fences, except as permitted in *Sec. 4C.11.2 (Temporary Signs)*.

- f. Are affixed to any vehicle or trailer on private property if the vehicle or trailer is not intended to be otherwise used in the business and the sole purpose of attaching the sign to the vehicle or trailer is to attract people to a place of business.
- g. Emit audible sounds, odor or visible matter.
- h. Use human beings, live animals, animated figures, motion pictures or projectors or any other means that causes continuous motion in connection with any sign.
- i. Are supergraphic signs, except where supergraphic signs are specifically permitted pursuant to a legally-adopted Specific Plan, a Supplemental Use District, an approved development agreement or a Sign District. In addition, despite the provisions of *Sec. 13B.10.1.B. (Vesting of Development Plan)*, this prohibition does not apply to any building permit issued prior to August 14, 2009 if the Department of Building and Safety determines that both substantial liabilities have been incurred, and substantial work has been performed on-site, in accordance with the terms of that permit pursuant to *Chapter 9, Section 91.106.4.3.1*.
- j. Are off-site signs, including off-site digital displays, except when off-site signs are specifically permitted by pursuant to a relocation agreement entered into pursuant to *California Business and Professions Code Section 5412*. This prohibition also applies to alterations, enlargements or conversions to digital displays of legally existing off-site signs, except for alterations that conform to the provisions of *Chapter 9, Section 91.6216 (Existing Signs)* and all other requirements of this Code. This prohibition does not apply to off-site signs, including off-site digital displays, that are specifically permitted pursuant to a legally-adopted Specific Plan, a Supplemental Use District, an approved development agreement or a Sign District. In addition, despite the provisions of *Sec. 13B.10.1.B. (Vesting of Development Plan)*, this prohibition does not apply to any building permit issued prior to August 14, 2009 if the Department of Building and Safety determines that both substantial liabilities have been incurred, and substantial work has been performed on-site, in accordance with the terms of that permit pursuant to *Chapter 9, Section 91.106.4.3.1 (Limit of Authorization)*.
- k. Are inflatable devices, except where inflatable devices are specifically permitted pursuant to a legally-adopted Specific Plan, a Supplemental Use District, an approved development agreement or a Sign District.

9. **Prohibited Locations**

- a. No sign or sign support structure shall project into any public alley, except that a sign or sign support structure above a height of 14 feet may project no more than 6 inches into a public alley.
- b. No sign or sign support structure shall be located less than 6 feet horizontally or 12 feet vertically from overhead electrical conductors energized in excess of 750 volts. As used here, the term overhead electrical conductors means any electrical conductor, either bare

or insulated, installed above-ground, except electrical conductors that are enclosed in iron pipe or other material covering of equal strength. Arcs of 6-foot radius may be used to define corners of the prohibition area.

- c. No sign or sign support structure shall be erected in a visibility triangle as defined by *LAMC Chapter 6, Section 62.200 (Street Intersections - Obstructions to Visibility)*.
- d. No sign or sign support structure shall be located within 2 feet of the curb or edge of any roadway.

10. Temporary Signs

For additional standards applicable to temporary signs, see *Sec. 4C.11.2 (Temporary Signs)*.

11. Off-site Signs

For additional standards applicable to off-site signs, see *Sec. 4C.11.3 (Off-Site Signs)*.

12. On-Site Signs

For additional standards applicable to on-site signs, see *Sec. 4C.11.4 (On-Site Signs)*.

D. Measurement

For the measurement of footcandle, see *Sec. 4C.10.1.D. (Measurement)*.

E. Exceptions

1. Wall Signs

Wall signs in compliance with all of the standards below are exempt from the limitations in *Sec. 4C.11.1.C.6. (Freeway Exposure)*.

- a. The total area of all wall signs on a building shall not exceed 100 square feet.
- b. An individual wall sign shall not exceed 50 square feet in area.
- c. Wall signs that can be viewed primarily from an off ramp and not from the main traveled roadway of a freeway.
- d. Wall signs shall not have moving parts or any arrangement of lights that create the illusion of movement.

2. Original Art Murals, Vintage Original Art Murals and Public Art Installations

a. General

- i. A building permit from the Department of Building and Safety is required for the necessary physical alterations to a building or other structures due to a new hand-tiled or digitally printed original art mural or any public art installation that may require a building permit.

- ii. If any part, sentence, phrase, clause, term or word in this *Sec. 4C.11.1.E.2. (Original Art Murals, Vintage Original Art Murals and Public Art Installations)*, relating to original art murals, vintage original art murals, or public art installations is declared invalid or unconstitutional by a valid court judgment or decree of any court of competent jurisdiction, the declaration of such unconstitutionality does not affect the constitutionality or lawfulness of the remainder of this zoning code (Chapter 1A), the LAAC or any other City regulation regulating signage, billboards or original art murals.

b. Original Art Mural

A one-of-a-kind, hand-painted, hand-tiled, or digitally printed image on the exterior wall of a building that does not contain any commercial message.

- i. An original art mural that conforms to the requirements of *Chapter 7, Section 22.119 (Original Art Murals on Private Property)* of the Los Angeles Administrative Code is not considered a sign and is not subject to the provisions of this *Div. 4C.11. (Signs)* or any other ordinance that regulates signs.
- ii. Any supposed "mural" that does not conform to the requirements of *Chapter 7, Section 22.119 (Original Art Murals on Private Property)* of the Los Angeles Administrative Code is considered a sign and is subject to the provisions of this *Div. 4C.11. (Signs)* or any other ordinance that regulates signs and digital displays.

c. Vintage Original Art Mural

An original art mural that existed prior to October 12, 2013 (the operative date of Los Angeles Ordinance No. 182706).

- i. A vintage original art mural that conforms to the requirements of *LAAC Chapter 7, Section 22.119.(c) (Grandfathering of Vintage Original Art Murals)* is not considered a sign and is not subject to the provisions of this *Div. 4C.11. (Signs)* or any other ordinance that regulates signs.

d. Public Art Installation

A facility, amenity or project that does not contain any commercial message and which is either an "approved public arts project" as defined by *LAAC Chapter 6, Section 19.85.4* or approved pursuant to *LAMC Chapter 9, Section 91.107.4.6 (Arts Development Fee)*.

- i. A public art installation registered pursuant to the requirements of *LAMC Chapter 6, Section 19.85.4 (Direct Expenditures on Approved Arts Projects)* or the requirements of *LAMC Chapter 9, Section 91.107.4.6. (Arts Development Fee)* is not considered a sign, but is subject to *Sec. 4C.11.1.C.3. (Sign Illumination Limitations)* and any other applicable zoning and land use regulations set forth in the LAMC.

F. Relief

1. A deviation from any rules for all signs dimensional standard of up to 15% may be requested in accordance with *Sec. 13B.5.2 (Adjustment)*.
2. Deviation from any rules for all signs standard may be allowed as a variance in accordance with *Sec. 13B.5.3 (Variance)*.

SEC. 4C.11.2. **TEMPORARY SIGNS**

Any sign that is to be maintained for a limited duration, including paper signs, posters, pennants, banners, ribbons, streamers, spinners, and other signs that are not permanently affixed to the ground or building.

A. Intent

See Sec. 4C.11.1.A. (*Intent*).

B. Applicability

All temporary signs and sign support structures not located entirely in the public right-of-way shall conform to the requirements of this *Div. 4C.11. (Signs)* and all other applicable provisions of this zoning code (Chapter 1A).

C. Standards

1. Permit Required

- a.** A building permit is required for a temporary sign, pennant, banner, ribbon, streamer or spinner. The permit application shall specify the dates being requested for authorized installation and the proposed location.
- b.** Notwithstanding any other provision of this zoning code (Chapter 1A), a building permit shall be required for a temporary sign, other than one that contains a political, ideological or other noncommercial message. The permit application shall specify the dates being requested for authorized installation and the proposed location.

2. General

Temporary signs may display only on-site or noncommercial messages.

3. Temporary Signs

a. Location

Temporary signs may, including those that do not require a building permit, be tacked, pasted or otherwise temporarily affixed to windows or on the walls of buildings, barns, sheds or fences.

b. Area

- i.** The combined sign area of temporary signs shall not exceed 10 square feet in an Agricultural or Residential Use District, or 2 square feet for each foot of street frontage in all other Use Districts. Square footage for temporary signs shall not be counted toward the total sign area allocation from the Sign Packages, See Sec. 4C.11.5. (*Sign Packages*).

- Signs -

- ii. The combined sign area of temporary signs, when placed upon a window and any other window signs shall not exceed a maximum of 10% of the window area.

c. **Construction**

Temporary signs may be made of paper or any other material. If the temporary sign is made of cloth, it shall be flame-proofed when the aggregate area exceeds 100 square feet. Every temporary cloth sign shall be supported and attached with stranded cable of 1/16-inch minimum diameter or by other methods as approved by the Department of Building and Safety.

d. **Time Limit**

- i. Temporary signs that require a permit shall be removed within 30 days of installation and shall not be reinstalled for a period of 30 days of the date of removal of the previous sign. The installation of temporary signs shall not exceed a total of 90 days in any calendar year.
- ii. Temporary signs that do not require a permit shall be removed within 30 days of the date of installation of the sign.

D. **Measurement**

[Reserved]

E. **Relief**

1. A deviation from any temporary sign dimensional standard of up to 15% may be requested in accordance with *Sec. 13B.5.2 (Adjustment)*.
2. Deviation from any temporary sign standard may be allowed as a variance in accordance with *Sec. 13B.5.3 (Variance)*.

SEC. 4C.11.3. **OFF-SITE SIGNS**

A sign that displays any message directing attention to a business, product, service, profession, commodity, activity, event, person, institution, or any other commercial message, which is generally conducted, sold, manufactured, produced, offered or occurs elsewhere than on the premises where the sign is located.

A. Intent

See Sec. 4C.11.1.A. (Intent).

B. Applicability

All exterior off-site signs, including window signs, and sign support structures not located entirely in the public right-of-way shall conform to the requirements of this Section and all other applicable provisions of this Zoning Code (Chapter 1A).

C. Standards

1. Location

- a.** No portion of an off-site sign with a sign area greater than 80 square feet shall be placed within 200 feet of a lot or a property zoned with a Residential Use District, which is located on the same side of the same street as the lot on which the sign is placed. However, where a lot has 2 or more street frontages, a sign may be located on that street frontage, which is not on the same street as the lot or property zoned with a Residential Use District; provided the sign and sign support structure are placed in that half of the lot that is the farthest from the street frontage on which the lot is located.
- b.** No portion of an off-site sign or sign support structure can be located in that half of a lot located farthest from the street frontage when a lot or a property zoned with a Residential Use District is located to the rear of that street frontage.
- c.** Off-site signs are not permitted along that portion of a lot having a street frontage of less than 50 feet.
- d.** No more than 4 off-site signs can be located at the intersection of 2 or more streets when the off-site signs are located within 150 feet of the intersection of 2 street frontages.
- e.** An off-site sign face shall not be located within 1 foot of a side lot line.

2. Area

The sign area of a single face cannot exceed 800 square feet.

3. Height

- a. The height to the top of the off-site sign is limited to a maximum of 42 feet above the sidewalk grade or edge of roadway grade nearest the sign, except that a sign that is more than 80% above a roof of a building may extend to the top of the sign a maximum of 30 feet above the surface of the roof under the sign.
- b. In no event can the height to the top of the off-site sign exceed a height greater than that height specified in the Form District in which the sign is located, or a height of 60 feet above the sidewalk grade or edge of roadway grade nearest the sign, whichever is more restrictive.
- c. The bottom of the off-site sign shall be at least 8 feet above the sidewalk grade or edge of roadway grade nearest the sign.

4. Spacing

An off-site sign, which is either single-faced or parallel double-faced, shall be spaced as specified below from any other existing or previously permitted off-site sign, which is single-faced or parallel double-faced.

SPACING REQUIREMENTS BETWEEN OFF-SITE SIGNS			
Existing or Permitted Sign by Sign Area	Proposed Sign by Sign Area		
	<80 SF	80 - 300 SF	>300 SF
<80 SF	100'	100'	200'
80 - 300 SF	100'	300'	300'
>300SF	200'	300'	600'

5. Double-Faced Off-site Signs

- a. Off-site signs may be either single or double-faced.
- b. For double-faced off-site signs whose faces are parallel, the distance between sign faces cannot exceed 6 feet.
- c. For double-faced off-site signs whose faces are not parallel, the distance between sign faces at their widest point cannot exceed 35 feet. The separation of sign faces at their closest point cannot exceed 6 feet. In no event can the angle between sign faces exceed 37 degrees.

6. Projection

Off-site signs shall not project over the public right-of-way.

7. Covering

The backs of off-site signs exposed to public view shall be covered with a finished surface or material and shall be properly maintained.

8. Other Requirements

- a. A maximum of two poles are permitted for any off-site sign. The maximum cross-sectional dimension of a pole cannot exceed 10% of the overall height of the sign.
- b. Off-site sign supports shall be structurally independent of a building.
- c. Sign support structures shall be located directly under the sign face as viewed from the front of the sign. The maximum horizontal distance between the center of the sign support structure and the sign face can not exceed 10 feet.

D. Measurement

1. Lots with Multiple Street Frontages

If a lot is a corner lot or any other lot with two or more street lot lines, the following rules for the determination of which street an off-site sign is located on shall apply:

- a. For the purposes of *Sec. 4C.11.3.C.2 (Area)* and *Sec. 4C.11.3.D. (Measurement)*, an off-site sign shall be considered to be on a single street, if the sign and its support structure are located entirely on the side of the bisecting line closest to that street and the sign face is placed at the same angle as the perpendicular line or at an angle not to exceed 20 degrees from either side of the perpendicular line.

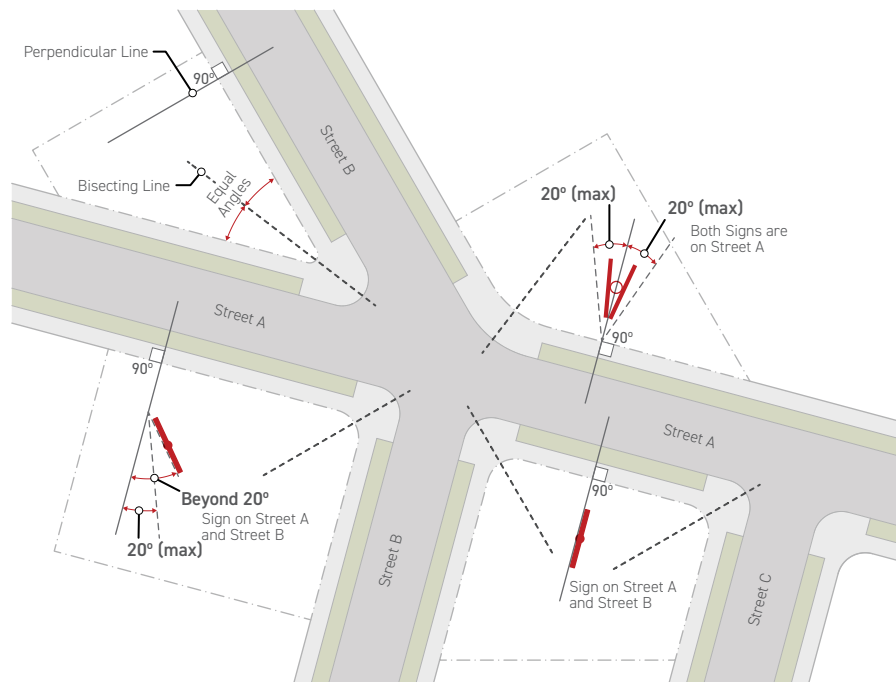

- b. An off-site sign located on a through lot shall be located on a single street if the sign and its support structure are located entirely on that half of the lot closest to the lot line adjoining that street.

- c. Any off-site sign not in conformance with either *Sec. 4C.11.3.D.1.a.* or *Sec. 4C.11.3.D.1.b.* is considered to be located on more than one street frontage.

2. Spacing

- a. For any double-faced off-site sign, the spacing requirements are based on the area of the largest sign face.
- b. For double-faced off-site signs whose faces are not parallel, the spacing between any proposed, permitted or existing off-site sign is determined by the following formula:

$$D = S \left[1 + \frac{(B - 5)}{90} \right]$$

Where:

D = required spacing between signs, in feet.

S = sign spacing determined by the table in *Sec. 4C.11.3.C.4. (Spacing)*.

B = widest edge separation of sign faces in feet.

- c. Spacing is measured between off-site signs that are located on the same side of the same street. Spacing is measured from a line that is perpendicular to the street line and that passes through a point on the street line that is closest to the nearest sign face edge. Spacing is measured along the center line of the street.

E. Relief

1. A deviation from any off-site sign dimensional standard of up to 15% may be requested in accordance with *Sec. 13B.5.2 (Adjustment)*.
2. Deviation from any off-site sign standard may be allowed as a variance in accordance with *Sec. 13B.5.3 (Variance)*.

SEC. 4C.11.4. **ON-SITE SIGNS**

A sign that is other than an off-site sign.

A. **Intent**

See *Sec. 4C.11.1.A. (Intent)*.

B. **Applicability**

All exterior signs, including window signs, and sign support structures not located entirely in the public right-of-way shall conform to the requirements of *Div. 4C.11. (Signs)* and all other applicable provisions of this Zoning Code (Chapter 1A).

C. **Standards**

1. **Sign Packages**

On-site signs shall comply with all the applicable sign package.

2. **Sign Types**

On-site signs shall comply with all applicable sign type standards.

3. **Street Address Requirement**

No sign shall be maintained on any property unless a street address for the property has been obtained, and is maintained in accordance with the provisions of *LAMC Chapter 6, Section 63.113 (Street Address Numbers - Responsibility Therefor, Designation, Location, Size, Maintenance, Change and Removal)*.

4. Projection Over the Public Right-Of-Way

Where on-site signs are allowed to project over the public right-of-way, they shall comply with the following standards:

- a. An on-site sign with a clear height less than 8 feet has a maximum projection allowance of 0.25 inches.
- b. An on-site sign with a clear height equal to 8 feet has a maximum projection allowance of 1 foot.
- c. For every extra foot of clear height over 8 feet, the projection maximum for on-site signs increases by half an inch.
- d. The maximum allowed projection for any on-site sign is 5 feet, which applies to on-site signs with a clear height of 16 feet or greater.

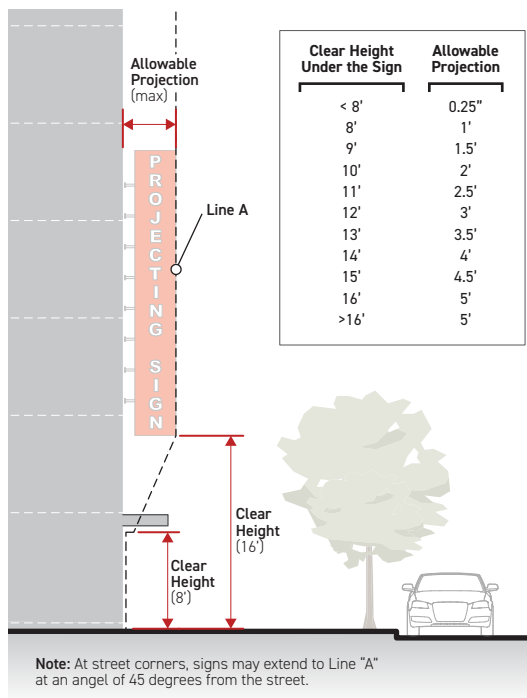

D. Measurement

See Sec. 4C.11.6.D. (*Measurement, Sign Types*).

E. Relief

1. A deviation from any on-site sign dimensional standard of up to 15% may be requested in accordance with Sec. 13B.5.2 (*Adjustment*).
2. Deviation from any on-site sign standard may be allowed as a variance in accordance with Sec. 13B.5.3 (*Variance*).

SEC. 4C.11.5. SIGN PACKAGES

A. Intent

The intent of the sign packages is to provide variety in the sign allocation based on the extent of reliance on specific modes of travel.

1. Sign Package 1 is intended for areas with a variety of transportation modes.
2. Sign Package 2 is intended for areas with a focus on pedestrian experience and alternative transportation modes besides automobiles.

B. Applicability

Sign package standards apply to all on-site signs determined by the sign package assigned by the applicable Development Standards District.

C. Standards

1. Digital Display

Digital displays are prohibited in Sign Package 2.

2. Total Sign Area Allowed

- a. The maximum total area of on-site signs allowed on a lot is specified by sign package according to the category of the applied Use District (Part 5B) as specified below:

	Sign Package 1	Sign Package 2
AGRICULTURAL, RESIDENTIAL & OPEN SPACE USE DISTRICTS		
Total Sign Area Allocation for All Sign Types Allowed (max)	30 SF	30 SF
ALL OTHER USE DISTRICTS		
Total Sign Area Allocation for All Sign Types Allowed (max)	4 SF per foot of street frontage	4 SF per foot of building frontage
Combined Sign Area of Illuminated Canopy Signs, Roof Signs, Roof Signs: Open Panel & Wall Signs Facing the Same Direction (max)	2 SF per foot of street frontage, + 1 SF for each foot of building frontage	n/a

- b. In Sign Package 1, Awning Signs, High Rise Signs and Marquee Signs do not count towards the total sign area allocation of 4 square feet per foot of street frontage.
- c. In Sign Package 2, Awning Signs and Tall Building Signs do not count towards the total sign area allocation of 4 square feet per foot of street frontage.

3. Sign Types Allowed

		Sign Package 1	Sign Package 2
AGRICULTURAL, RESIDENTIAL & OPEN SPACE USE DISTRICTS			
Awning Sign	(Sec. 4C.11.6.C.1.)	●	●
High Rise Sign 1	(Sec. 4C.11.6.C.2.)	○	○
Illuminated Canopy Sign	(Sec. 4C.11.6.C.3.)	○	○
Marquee Sign	(Sec. 4C.11.6.C.4.)	○	○
Monument Sign	(Sec. 4C.11.6.C.5.)	●	●
Pedestrian Sign	(Sec. 4C.11.6.C.6.)	○	○
Pole Sign	(Sec. 4C.11.6.C.7.)	●	○
Projecting Sign	(Sec. 4C.11.6.C.8.)	○	○
Roof Sign	(Sec. 4C.11.6.C.9.)	○	○
Roof Sign: Open Panel	(Sec. 4C.11.6.C.10.)	○	○
High-Rise 2 Sign	(Sec. 4C.11.6.C.11.)	○	○
Wall Sign	(Sec. 4C.11.6.C.12.)	●	●
Window Sign	(Sec. 4C.11.6.C.13.)	○	○
Yard Sign	(Sec. 4C.11.6.C.14.)	●	●
ALL OTHER USE DISTRICTS			
Awning Sign	(Sec. 4C.11.6.C.1.)	●	●
High Rise Sign 1	(Sec. 4C.11.6.C.2.)	●	○
Illuminated Canopy Sign	(Sec. 4C.11.6.C.3.)	●	○
Marquee Sign	(Sec. 4C.11.6.C.4.)	●	●
Monument Sign	(Sec. 4C.11.6.C.5.)	●	●
Pedestrian Sign	(Sec. 4C.11.6.C.6.)	●	●
Pole Sign	(Sec. 4C.11.6.C.7.)	●	○
Projecting Sign	(Sec. 4C.11.6.C.8.)	●	●
Roof Sign	(Sec. 4C.11.6.C.9.)	●	○
Roof Sign: Open Panel	(Sec. 4C.11.6.C.10.)	○	●
High-Rise 2 Sign	(Sec. 4C.11.6.C.11.)	○	●
Wall Sign	(Sec. 4C.11.6.C.12.)	●	●
Window Sign	(Sec. 4C.11.6.C.13.)	●	●
Yard Sign	(Sec. 4C.11.6.C.14.)	○	○

● = Sign type not allowed

○ = Sign type allowed

- a. Where a sign meets the standards and definition of both an allowed sign type and a sign type that is not allowed per the table in this paragraph, the sign is considered to be the allowed sign type.

D. Measurement

1. Sign Area

- a. Maximum sign area is measured independently for each sign face.
- b. Sign area is measured as the area circumscribed by the smallest geometric shape created with a maximum of eight straight lines that will enclose all words, letters, figures, symbols, designs and pictures, together with all framing, background material, colored or illuminated areas and attention-attracting devices, forming an integral part of an individual message except that:
 - i. For wall signs having no discernible boundary, each of the following shall be included in any computation of surface area:
 - a) The areas between letters;
 - b) Words intended to be read together; and
 - c) Any device intended to draw attention to the sign message.
 - ii. For spherical, cylindrical or other three-dimensional signs, the area of the sign shall be computed from the smallest two-dimensional geometrical shape or shapes, which will best approximate the greatest actual surface area visible from any one direction. Sign support structures are excluded if neutral in color.

2. Sign Area Allocation

- a. Sign area allocation, either total or by sign type, when specified per foot of street frontage is calculated by multiplying the specified area by the length of the street frontage.
- b. Sign area allocation, either total or by sign type, when specified per foot of building frontage is calculated by multiplying the specified area by the length of the building frontage.
- c. The sign area for all signs, including required signs and signs displaying addresses, is counted toward the total sign area allocation as specified in Sec.4C.11.5.C. (Sign Packages).

E. Exceptions

Flag lots containing less than 50 feet of street frontage are allotted 50 feet of street frontage for the purpose of determining the type of sign permitted and for the allowable sign area.

F. Relief

1. In sign package 2, deviations from the dimensional standards for projecting signs shall be authorized in accordance with *Sec. 13B.2.5. (Director Determination)*. In addition to the findings otherwise required by *Sec. 13B.2.5. (Director Determination)*, the Director of Planning shall find that the proposed projecting sign meets the following criteria:

- Signs -

- a. The total sign area of all projecting signs, including existing projecting signs and existing pole signs (*Sec. 4C.11.6.C.8.ii.*), does not exceed 25 SF plus 1.5 SF per foot of street frontage, with no individual projecting sign exceeding 300 SF per sign face; and
 - b. The proposed projecting sign contributes to the existing pattern and character of signs of the area within a 500 foot radius of the site.
2. A deviation from any sign package dimensional standard of up to 10% may be requested in accordance with *Sec. 13B.5.2 (Adjustment)*.
3. Deviation from any sign package standard may be allowed as a variance in accordance with *Sec. 13B.5.3 (Variance)*.

SEC. 4C.11.6. **SIGN TYPES**

A. **Intent**

That the regulations will provide reasonable protection to the visual environment by controlling the size, height, spacing and location of signs.

B. **Applicability**

1. **General**

- a. Any project including the construction or modification of an on-site sign.
- b. Sign type standards apply to each lot according the Sign Package (*Sec. 4C.11.5.C.*) specified by the applied Development Standards District.

2. **Combination Signs**

A sign subject to more than one type of classification, shall meet the requirements for the type to which each portion is subject.

C. **Standards**

The standards for each sign type are specified in the tables below:

1. Awning Sign



DEFINITION

A sign painted, sewn, or otherwise adhered to the material of an awning as an integrated part of the awning itself.

GENERAL STANDARDS

- i. Signs are only allowed on awnings that comply with all applicable provisions of *LAMC Sec. 91.3202 (General)*, *LAMC Sec. 91.3202.3.1 (Awnings, Canopies, Marquees and Signs)*.
- ii. No sign can be placed on any portion of an awning except the valance that is parallel to the building face. No sign can extend outside the awning.
- iii. Signs are not allowed on awnings with a valance above 14 feet in height measured from the nearest sidewalk or edge of roadway grade to the top of the valance.

Sign Package 1 Sign Package 2

SIGN TYPE PERMISSIONS

	Sign Package 1	Sign Package 2
OS, A, & RG Use Districts	●	●
All other Use Districts	●	●

● = Sign type allowed ○ = Sign type not allowed

Sign Package 1 Sign Package 2

DIMENSIONAL STANDARDS

	Sign Package 1	Sign Package 2
Combined sign area for all Awning Signs (max)		
OS, A, & RG Use Districts	n/a	n/a
All other Use Districts	2 SF per foot of street frontage	2 SF per foot of street frontage
A Area of individual Awning Sign (max)		
OS, A, & RG Use Districts	20 SF	20 SF
All other Use Districts	n/a	12 SF
B Sign display height (max)	1'	1'

2. High-Rise Sign 1

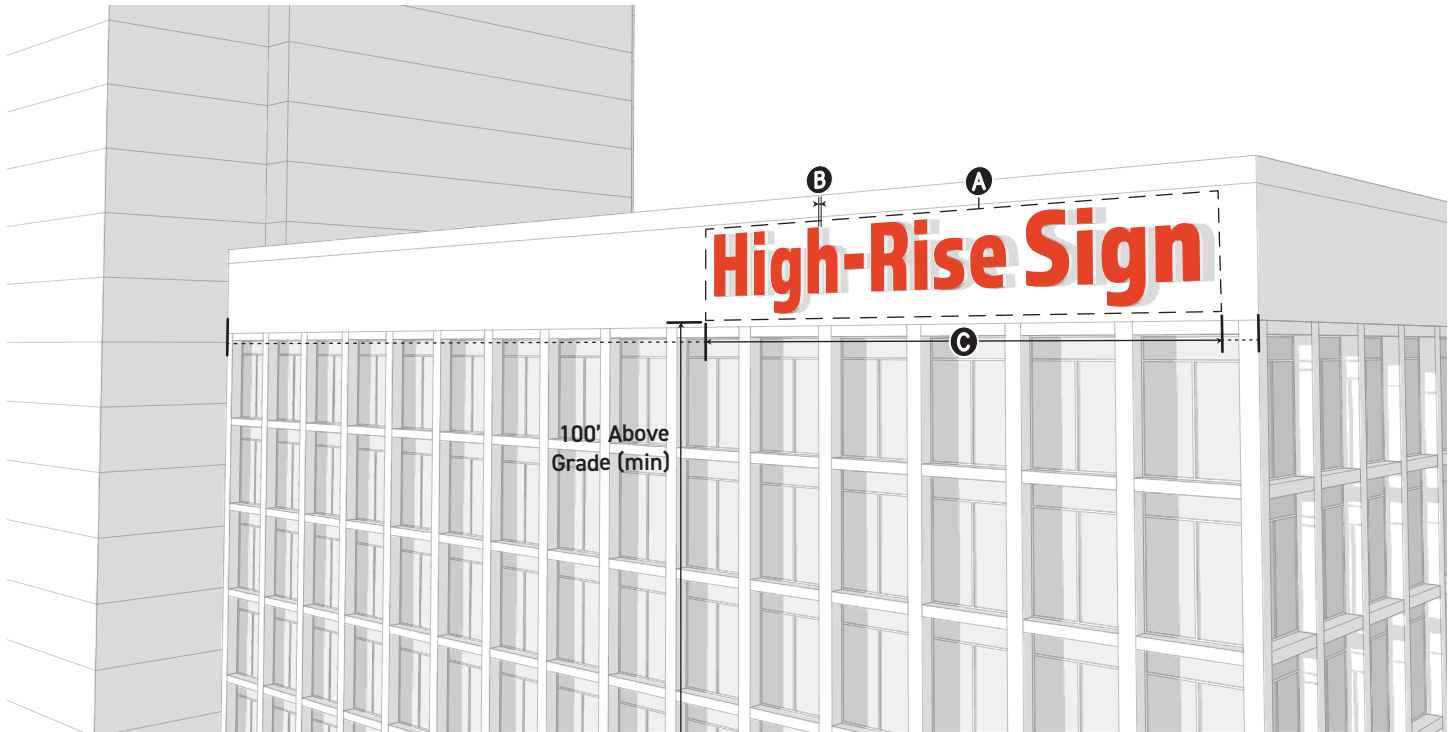

DEFINITION

A sign located at least 100 feet above grade and attached to the wall of a building.

GENERAL STANDARDS

- i. The plane of the sign face of a high-rise 1 sign shall be approximately parallel to the face of the building.
- ii. A high-rise 1 sign shall not extend above the top of the wall of the building, except where there is less than 3 feet between the top of the wall and the top of a window, the high-rise 1 sign may extend above the top of the wall by a maximum of 3 feet.

	Sign Package 1	Sign Package 2
--	----------------	----------------

SIGN TYPE PERMISSIONS

OS, A, & RG Use Districts	○	○
All other Use Districts	●	○

● = Sign type allowed ○ = Sign type not allowed

DIMENSIONAL STANDARDS

Combined sign area for all High-Rise 1 Signs (max)	n/a
A Area of individual High-Rise 1 Sign (max)	5% of the area of the building wall to which the sign is attached
B Projection from building face (max)	2'
C Width (max % of facade length)	80%

3. Illuminated Canopy Sign



DEFINITION

A sign integrated into an enclosed internally illuminated canopy that is attached to the wall of a building.

GENERAL STANDARDS

- i. An illuminated canopy sign shall not extend above the top of the wall of a building.
- ii. For emergency personnel access, illuminated canopy signs shall not occupy a 4-foot distance along the exterior wall at one corner of the building's street frontage and an additional 4-foot distance along every 50 feet of the building frontage.
- iii. An illuminated canopy sign shall bear the electric sign label of an approved testing agency with a re-inspection service.
- iv. Only canopies at grade level may contain illuminated canopy signs over a door or window.
- v. An illuminated canopy sign shall be internally illuminated so as to illuminate the canopy and the exterior wall below.
- vi. Illuminated canopy signs may project over a public right-of-way.

	Sign Package 1	Sign Package 2
--	----------------	----------------

SIGN TYPE PERMISSIONS

OS, A, & RG Use Districts	○	○
All other Use Districts	●	○

● = Sign type allowed ○ = Sign type not allowed

DIMENSIONAL STANDARDS

Combined sign area for all Illuminated Canopy Signs (max)	2 SF per foot of street frontage
A Area of individual Illuminated Canopy Sign (max)	n/a
B Sign display height (max)	3'
Depth (max)	8"
C Clear height (min)	8'-2"
D Projection from building face (max)	3'

4. Marquee Sign



DEFINITION

A sign attached to the periphery of a marquee.

GENERAL STANDARDS

- i. Signs shall not extend above or below the marquee.
- ii. Signs shall not be attached to any portion of the marquee except on the periphery.
- iii. Cloth or banner signs or drop-roll curtains may be suspended below the exterior periphery and extend within 7 feet of the grade.

	Sign Package 1	Sign Package 2
--	----------------	----------------

SIGN TYPE PERMISSIONS

OS, A, & RG Use Districts	○	○
All other Use Districts	●	●

● = Sign type allowed ○ = Sign type not allowed

DIMENSIONAL STANDARDS

Combined sign area for all Marquee Signs (max)	n/a
A Area of individual Marquee Sign (max)	Limited by marquee size

5. Monument Sign

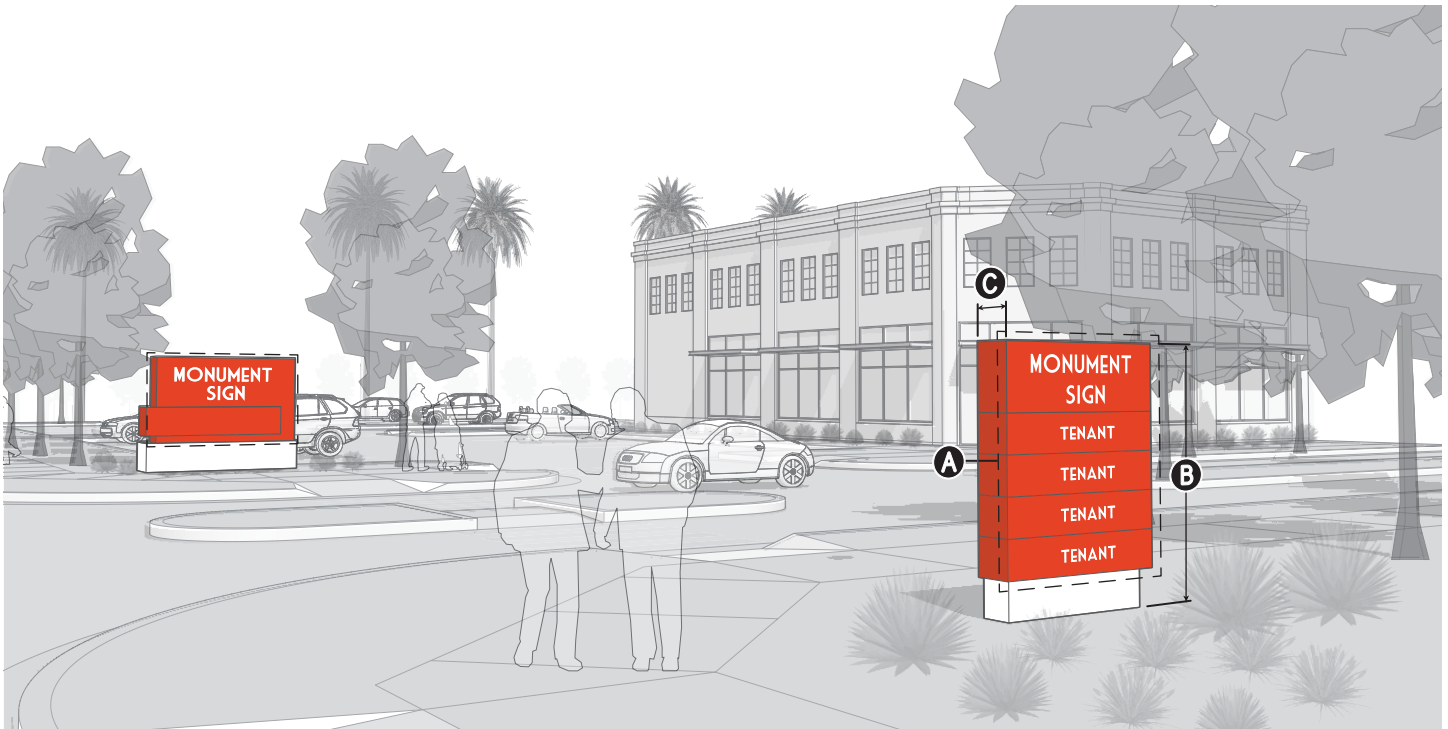

DEFINITION

A freestanding sign which is wholly independent of a building for support, erected directly upon the original grade or finished grade, or that is raised no more than 12 inches from the grade to the bottom of the sign.

GENERAL STANDARDS

- i. A monument sign shall be set back at least 7.5 feet from a side lot line.
- ii. A monument sign shall be located at least 15 feet from any other monument sign, projecting sign or pole sign in any direction.
- iii. A monument sign shall be located so as not to present a physical visibility obstruction that could interfere with or present a hazard to pedestrian or vehicular traffic.
- iv. A monument sign shall not project over a public right-of-way.

Sign Package 1 Sign Package 2

SIGN TYPE PERMISSIONS

	Sign Package 1	Sign Package 2
OS, A, & RG Use Districts	●	●
All other Use Districts	●	●

● = Sign type allowed ○ = Sign type not allowed

DIMENSIONAL STANDARDS

	Sign Package 1	Sign Package 2
Combined sign area for all Monument Signs (max)		
OS, A, & RG Use Districts	n/a	n/a
All other Use Districts	1.5 SF per foot of street frontage	1.5 SF per foot of building frontage
A Area of individual Monument Sign (max)		
OS, A, & RG Use Districts	9 SF per sign face	9 SF per sign face
All other Use Districts	75 SF per sign face	32 SF per sign face
Number of Monument Signs allowed (max)		
OS, A, & RG Use Districts	1	1
All other Use Districts	n/a	n/a
B Height (max)		
A & RG Use Districts	6'	6'
All other Use Districts	8'	8'
C Depth (max)	2'	2'

6. Pedestrian Sign



DEFINITION

A small sign attached perpendicular to the building facade that hangs from a bracket or support.

GENERAL STANDARDS

- i. A hanging bracket shall be an integral part of the sign design.
- ii. Pedestrian signs shall be located below the window sills of the 2nd story on a multi-story building or below the top of the exterior wall on a single-story building.
- iii. Pedestrian signs shall be located within 5 feet horizontally of a ground story tenant entrance.
- iv. Pedestrian signs shall be located at least 15 feet from any other pedestrian sign or projecting sign.
- v. Pedestrian signs shall be attached to a building to withstand the loads as required by *LAMC Sec. 91.6212*.
- vi. Pedestrian signs shall comply with *Sec. 4C.11.4.C.4 (Projection Over the Public Right-Of-Way)*.

	Sign Package 1	Sign Package 2
--	----------------	----------------

SIGN TYPE PERMISSIONS

OS, A, & RG Use Districts	○	○
All other Use Districts	●	●

● = Sign type allowed ○ = Sign type not allowed

DIMENSIONAL STANDARDS

Combined sign area for all Pedestrian Signs (max)	n/a
A Area of individual Pedestrian Sign (max)	9 SF per sign face
B Sign display height (max)	3'
C Projection from building face (min/ max)	1'/3'
D Depth (max)	6"
E Clear height (min)	8'

7. Pole Sign

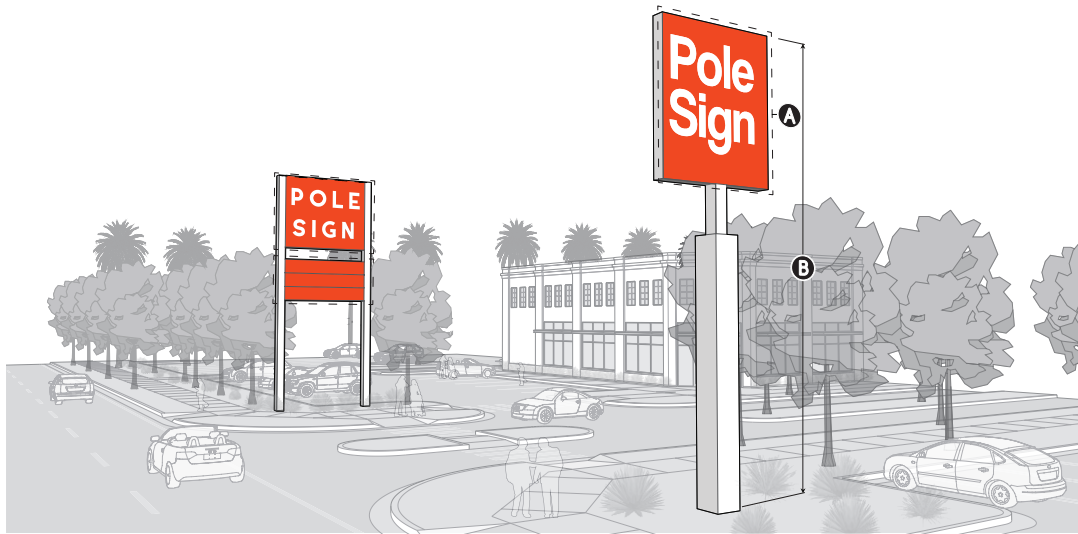

DEFINITION

A freestanding sign that is wholly independent of a building for support, permanently affixed to the ground using one or more poles or posts.

GENERAL STANDARDS

- i. A pole sign shall be located at least 10 feet from a side lot line; however, on a corner lot, a pole sign may be at least 5 feet from side lot lines.
- ii. A pole sign shall be located at least 15 feet from any other pole sign, projecting sign or monument sign.
- iii. The maximum width of a pole or post shall not exceed 10% of the overall sign height.
- iv. A pole sign shall be located so as not to interfere or present a hazard to pedestrian or automobile traffic.
- v. Where the lower part of a pole sign is less than 8 feet above sidewalk grade or the edge of roadway grade nearest the sign, the sign shall extend to 18 inches from grade or be installed in a planter that extends beyond the edges of the sign and any support structure that is 18 inches minimum in height.
- vi. A pole sign may project over a public right-of-way, but shall comply with *Sec. 4C.11.4. (Projection Over the Public Right-Of-Way)*. Sign projections shall fall within an area that is perpendicular to the public right-of-way and has a width of 3 feet as measured parallel to the public right-of-way.

	Sign Package 1	Sign Package 2
SIGN TYPE PERMISSIONS		
OS, A, & RG Use Districts	●	○
All other Use Districts	●	○

● = Sign type allowed ○ = Sign type not allowed

DIMENSIONAL STANDARDS

Combined sign area for all Pole Signs (max)		
OS, A & RG Use Districts		n/a
All other Use Districts		2 SF per foot of street frontage + 1 SF per foot of building frontage
Total number of Pole Signs & Projecting Signs (max)		
OS, A & RG Use Districts		1
All other Use Districts		
0' to < 50' of street frontage		0
50' to < 200' of street frontage		1
>200' to ≤ 400' of street frontage		2
>400' to ≤ 600' of street frontage		3
>600' of street frontage		+1 / 200' of street frontage
A Area of individual Pole Sign (max)		
OS, A & RG Use Districts		9 SF per sign face
All other Use Districts		400 SF per sign face
B Height⁽¹⁾ including pole (max)		
A & RG Use Districts		6'
All other Use Districts		
0' to < 50' of street frontage		none
50' of street frontage		25'
>50' to ≤ 100' of street frontage		35'
>100' of street frontage		42'

(1) Any pole sign located at the street corner of a corner lot may use the greater street frontage for determining height limitations. In no event may a pole sign, including the pole, exceed the maximum building height specified by the applied Form District.

8. Projecting Sign



DEFINITION

A sign attached approximately perpendicular to the building facade that does not meet the standards for a pedestrian sign (Sec. 4C.11.6.C.6.).

GENERAL STANDARDS

- i. The plane of the sign face shall be within 15 degrees of a line perpendicular to the face of the building, except at the corner of the building.
- ii. A projecting sign shall not extend above the top of the building wall.
- iii. A projecting sign shall be located at least 7.5 feet from any side lot line and be located at least 15 feet from any other projecting sign, monument sign or pole sign, measured in any direction.
- iv. Projecting signs shall be attached to a building to withstand the loads as required by LAMC Sec. 91.6212.
- v. A projecting sign may project over the public right-of-way, but shall comply with Sec. 4C.11.4. (Projection Over the Public Right-Of-Way). Sign projections shall fall within an area that is perpendicular to the public right-of-way and has a maximum width of 3 feet as measured parallel with the public right-of-way.
- vi. For projecting signs located above 16 feet and on a lot having a street frontage greater than 50 feet, projections over the public right-of-way may vary linearly from 5 feet at 50 feet to 8 feet at 100 feet of street frontage. This is an exception to the provision above (Sec 4C.11.6.C.8.vi.), and does not require compliance with Sec. 4C.11.6.D.2.

	Sign Package 1	Sign Package 2
--	----------------	----------------

SIGN TYPE PERMISSIONS

OS, A, & RG Use Districts	○	○
All other Use Districts	●	●

● = Sign type allowed ○ = Sign type not allowed

	Sign Package 1	Sign Package 2
--	----------------	----------------

DIMENSIONAL STANDARDS

	Sign Package 1	Sign Package 2
Combined sign area for all Projecting Signs (max)	25 SF + 1.5 SF per foot of street frontage	25 SF + 1.5 SF per foot of building frontage
Total number of Pole Signs & Projecting Signs (max)		
0' to < 50' of street frontage	0	0
50' to ≤ 200' of street frontage	1	1
>200' to ≤ 400' of street frontage	2	2
>400' to ≤ 600' of street frontage	3	3
>600' of street frontage	+1 / 200' of street frontage	+1 / 200' of street frontage
A Area of individual Project Sign (max)	300 SF per sign face	48 SF per sign face
B Projection from building face (max)	8'	5'
C Clear height (min)	8'	8'

9. Roof Sign

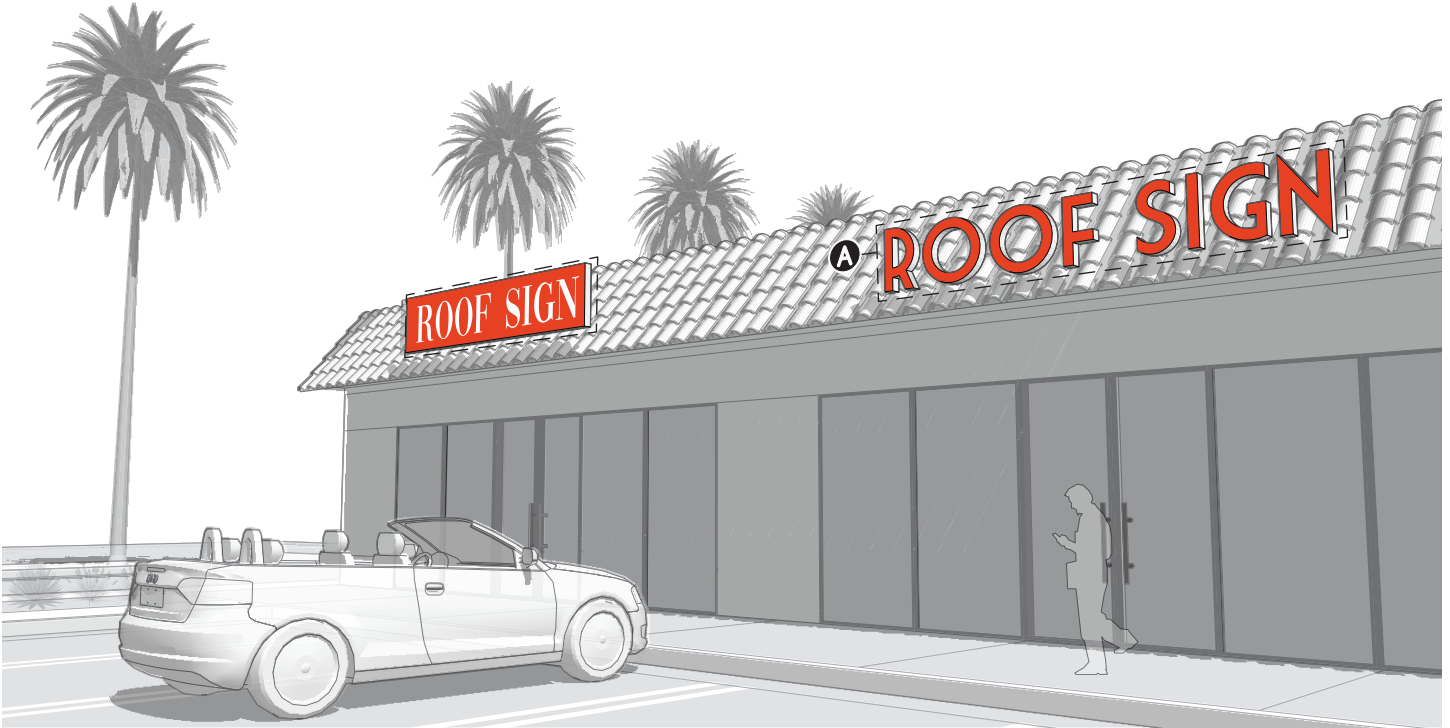

DEFINITION

A sign erected on a roof of a building.

GENERAL STANDARDS

- i. Roof signs are allowed only when placed directly upon a roof that slopes downward toward and extends to or over the top of an exterior wall.
- ii. The top of the roof sign shall be located at least 2 feet below the highest point of the roof where the sign is located.
- iii. Roof signs shall be located at least 2 feet from the edge of the roof.
- iv. Roof signs shall be located at least 10 feet from side lot lines.
- v. The plane of the sign face of a roof sign shall be approximately parallel to the face of the building.

	Sign Package 1	Sign Package 2
--	----------------	----------------

SIGN TYPE PERMISSIONS

OS, A, & RG Use Districts	○	○
All other Use Districts	●	○

● = Sign type allowed ○ = Sign type not allowed

DIMENSIONAL STANDARDS

Combined sign area for all Roof Signs (max)	2 SF per foot of street frontage, + 1 SF for each foot of building frontage
A Area of individual Roof Sign (max)	300 SF

10. Roof Sign: Open Panel

[Reserved]

DEFINITION

A sign erected on a roof of a building consisting of channel letters, graphic segments, open lighting elements, or other open forms affixed to a non-solid panel sign support structure.

GENERAL STANDARDS

- i. The sign shall be located on the roof of a building.
- ii. The plane of the sign face shall be approximately parallel to the face of the building.
- iii. The sign shall consist of open channel lettering or graphic segments. Box and cabinet signs are not allowed.

APPROVAL

Sign type only allowed accordance with *Sec. 13B.2.5. (Director Determination)*.

Supplemental Findings. The proposed sign contributes to the existing pattern and character of signs of the area within a 500 foot radius of the site.

Sign Package 1 Sign Package 2

SIGN TYPE PERMISSIONS

OS, A, & RG Use Districts	○	○
All other Use Districts	○	●

● = Sign type allowed ○ = Sign type not allowed

DIMENSIONAL STANDARDS

	Combined sign area for all Open Panel Roof Signs (max)	2 SF per foot of building frontage
A	Area of individual Open Panel Roof Sign (max)	80 SF
B	Sign display height (max height above roof-line or parapet)	3'
C	Distance from another roof sign (min)	15'

11.High-Rise Sign 2

[Reserved]

DEFINITION

A sign located at least 120 feet above grade and attached to the wall of a building.

GENERAL STANDARDS

- i. No building may have more than two high-rise 2 signs and no more than one on any side of the building. In the case of a cylindrical or elliptical building, the building should be considered to have four quadrants, which will in no case exceed 25% of the perimeter of the building. Both tall building signs on a building must be identical in design.
- ii. The plane of the sign face of a high-rise 2 sign shall be approximately parallel to the face of the building.
- iii. On a flat-topped building, high-rise 2 signs must be located between the top of the windows on the topmost floor and the top of the roof parapet or within an area 16 feet below the top of the roof parapet.
- iv. On buildings with stepped, non-flat, or otherwise articulated tops, high-rise 2 signs may be located within an area 16 feet below the top of the building or within an area 16 feet below the top of the parapet of the main portion of the building below the stepped or articulated top.

GENERAL STANDARDS

- i. High-rise 2 signs must be located on a wall and may not be located on a roof, including a sloping roof, and may not block any windows.
- ii. The sign shall consist of open channel lettering or graphic segments. Box and cabinet signs are not allowed.
- iii. High-rise 2 signs are limited to one line of text.

	Sign Package 1	Sign Package 2
SIGN TYPE PERMISSIONS		
OS, A, & RG Use Districts	○	○
All other Use Districts	○	●
● = Sign type allowed ○ = Sign type not allowed		

DIMENSIONAL STANDARDS

Combined sign area for all High-Rise 2 Signs (max)	n/a
A Area of individual High-Rise 2 Sign (max)	50% of the area of the building wall to which the sign is attached or 800 SF, whichever is less

12. Wall Sign



DEFINITION

A sign on the wall of a building or structure, with the exposed face of the sign in a plane approximately parallel to the plane of the wall, that has been attached to, painted on, or erected against the wall, projected onto the wall, or printed on any material which is supported and attached to the wall by an adhesive or other materials or methods.

GENERAL STANDARDS

- i. For wall signs made up of individual letters that use the wall of the building as background, sign area allocated in *Sec. 4C.11.5.C.2.* and *Sec. 4C.11.5.C.3.* may be increased by 20%, provided there is no change in color between the background and the surrounding wall area.
- ii. If any message is placed on the edge of a wall sign, then that portion of the wall sign is regulated as a pedestrian sign or a projecting sign.
- iii. A wall sign cannot extend above the top of the wall of the building, except where there is less than 3 feet between the top of the wall and the top of a window, the wall sign may extend above the top of the wall by a maximum of 3 feet.
- iv. The plane of the sign face of a wall sign shall be approximately parallel to the face of the building.
- v. Wall signs cannot be illuminated when installed on a wall that faces the rear or side lot line that is located within 30 feet of properties zoned with an Agricultural or Residential Use District and a Density District of 8 to 60 or 1L to 4L.
- vi. No wall sign shall project over any public property or any public right-of-way greater than that permitted in *Sec. 4C.11.4. (Projection Over the Public Right-Of-Way).*
- vii. Where a parking lot exists between a wall sign and the street, and there is a freestanding wall or fence between the parking lot and the street, a sign may be placed on the wall or fence provided the sign does not project beyond the lot line. The sign is limited to that portion of the wall or fence between 2.5' and 3.5' in height above the finished grade at the base of the wall generally facing the street.

	Sign Package 1	Sign Package 2
SIGN TYPE PERMISSIONS		
OS, A, & RG Use Districts	●	●
All other Use Districts	●	●
● = Sign type allowed ○ = Sign type not allowed		

	Sign Package 1	Sign Package 2
DIMENSIONAL STANDARDS		
Combined sign area for all Wall Signs (max)		
OS, A, & RG Use Districts	n/a	n/a
All other Use Districts		
Single story buildings	2 SF per foot of street frontage, + 1 SF for each foot of building frontage.	3 SF per foot of building frontage
Multistory buildings	2 SF per foot of street frontage, + 1 SF for each foot of building frontage, + 10% for each additional story (not to exceed 150% of single story max).	2 SF per foot of building frontage
A Area of individual Wall Sign (max)		
OS, A, & RG Use Districts	20 SF	20 SF
All other Use Districts	n/a	80 SF
B Projection from building face (max)	2'	1'

13. Window Sign



DEFINITION

A sign, except for a supergraphic sign, that is attached to, affixed to, leaning against, or otherwise placed within 6 feet of a window or door in a manner so that the sign is visible from outside the building.

GENERAL STANDARDS

The total area of all window signs shall not exceed 10% of the area of a single window pane or 10% of the aggregate area of all immediately adjacent window panes separated at most by a mullion, muntin or grid no thicker than 6 inches in width.

Sign Package 1 | Sign Package 2

SIGN TYPE PERMISSIONS

OS, A, & RG Use Districts	○	○
All other Use Districts	●	●

● = Sign type allowed ○ = Sign type not allowed

Sign Package 1 | Sign Package 2

DIMENSIONAL STANDARDS

Combined sign area for all Window Signs (max)	n/a	
A Area of individual Window Sign (max)	n/a	32 SF

14. Yard Sign



DEFINITION

A small sign placed in a yard or other amenity space.

GENERAL STANDARDS

Yard signs shall not have mechanical or moving parts and no electricity or other source of illumination or power may be attached or made a part of the sign.

Sign Package 1 | Sign Package 2

SIGN TYPE PERMISSIONS

	Sign Package 1	Sign Package 2
OS, A, & RG Use Districts	●	●
All other Use Districts	○	○

● = Sign type allowed ○ = Sign type not allowed

DIMENSIONAL STANDARDS

Combined sign area for all Yard Signs (max)	n/a
A Area of individual Yard Sign (max)	
Agricultural Use Districts	20 SF
OS & RG Use Districts	12 SF
B Height (max)	6'

D. Measurement

1. Sign Height

- a. The height of all signs permitted by this article, except for yard signs, shall be measured as the distance in a straight vertical line from the top of the sign to the sidewalk grade, or to the edge of roadway grade nearest the sign if there is no sidewalk. Yard sign height is measured from finished grade at the base of the sign.
- b. Any pole sign located at the street corner on a corner lot may use the greater of the two intersecting street frontages for determining maximum sign height. In no event can a sign exceed the height in which the sign is located.

E. Relief

1. A deviation from any sign type dimensional standard of up to 10% may be requested in accordance with *Sec. 13B.5.2 (Adjustment)*.
2. Deviation from any sign type standard may be allowed as a variance in accordance with *Sec. 13B.5.3 (Variance)*.

DIV. 4C.12. **SITE ELEMENTS**

SEC. 4C.12.1. **ROOF-MOUNTED EQUIPMENT**

A. **Intent**

To ensure roof mounted equipment is designed to minimize effects on surrounding properties and the public realm and to ensure roof-mounted equipment is obscured from view on the city skyline.

B. **Applicability**

All mechanical or utility equipment located on a roof, with the exception of solar panels and their required appurtenances and equipment for wireless telecommunication uses, shall meet the following screening standards. Rooftop wireless telecommunication uses shall be screened according to Sec. 4C.8.8. (*Wireless Telecommunication Facilities*).

C. **Standards**

1. Roof-mounted mechanical or utility equipment (including but not limited to, compressors, condensers, conduits, pipes, vents, and ducts) shall be screened on all sides by a parapet or screening enclosure that:
 - a. Is no less than 75% opaque;
 - b. Has a minimum height 6 inches greater in height than the topmost point of the equipment; and
 - c. Encloses the equipment 100% up to the minimum height of the screening structure.
2. The screening structure shall meet Sec. 4C.7.3 (*Fence/Wall Design & Installation*).

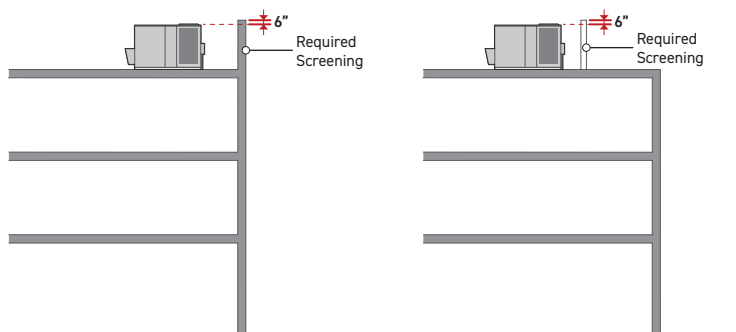

D. **Measurement**

1. For measurement of opacity see Sec. 14.1.13. (*Opacity %*).
2. For measurement of enclosure see Sec. 14.1.4. (*Enclosure*).

3. Height from topmost point of the equipment is measured to the top of the screening structure at its lowest height.

E. **Exceptions**

The following are exempt:

1. Sustainable energy systems;
2. Los Angeles Fire Department equipment;
3. Helipads; and
4. Window cleaning systems.

F. **Relief**

1. An alternative to roof-mounted equipment screening standards may be requested in accordance with *Sec. 13B.5.1 (Alternative Compliance)*.
2. A deviation from any roof-mounted equipment screening dimensional standard of up to 15% may be requested in accordance with *Sec. 13B.5.2 (Adjustment)*.
3. Deviation from any roof-mounted equipment screening standard may be allowed as a variance in accordance with *Sec. 13B.5.3 (Variance)*.

SEC. 4C.12.2. **GROUND-MOUNTED EQUIPMENT**

A. **Intent**

To minimize visibility of ground-mounted equipment from the public realm and support the intent of the applicable *Frontage District (Part 3B)*.

B. **Applicability**

1. Mechanical or utility equipment having the following characteristics:
 - a. Publicly or privately owned.
 - b. Located at an elevation within 6 feet of surrounding grade.
 - c. Serves 5 or more dwelling units or at least 5,000 square feet of floor area.
 - d. Does not include equipment for wireless telecommunication uses. These uses shall comply with *Sec. 4C.8.8. (Wireless Telecommunication Facilities)*.
2. Ground-mounted equipment screening standards do not apply to lots owned or leased by the Los Angeles Department of Water and Power.
3. Ground-mounted equipment standards do not apply to fire hydrants.

C. **Standards**

1. **Location**

- a. Ground mounted equipment located in a frontage yard shall be installed entirely below finished grade in a vault.
- b. Ground mounted equipment may be located within a building or structure, such as a utility room or parking garage, provided no portion of the equipment faces a frontage yard unobstructed.
- c. Ground mounted equipment may be located outdoors and above-grade provided that it meets the following standards:
 - i. No portion of the equipment is located in a frontage yard.
 - ii. When located on a corner lot, the equipment and its padmount shall not be located in the parking setback specified by the applied *Frontage District (Part 3B)*.
 - iii. Equipment is screened with a a fence/wall screen that meets the requirements of *Sec. 4C.12.C.2. (Fence/Wall Screen)* or a landscape screen that meets the requirements of *Sec. 4C.12.C.3. (Landscape Screen)*. Fence/wall screens and landscape screens may be combined to achieve full screening of the subject equipment.

2. Fence/Wall Screen

Fences or walls used to meet ground mounted equipment screening requirements shall meet the following standards:

- a. Form a screening enclosure that creates a contiguous perimeter around 100% of the subject equipment for a height no less that 6 inches taller than the topmost point of the equipment. In no case may the screening enclosure be less than 3 feet in height.

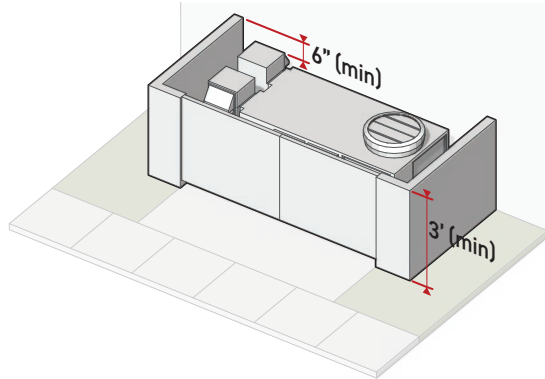

- b. Have a minimum opacity of 90%
- c. Access gates provided in the screening enclosure shall meet the following standards:
 - i. Shall have a height no less that 6 inches taller than the topmost point of the equipment.
 - ii. Where a screening enclosure is taller than the minimum height, gates may be no more than 1 foot shorter than the height of the wall or fence provided.
 - iii. In no case shall gates exceed the height of the screening enclosure by more than 1 foot.
 - iv. Has a minimum opacity of 90%.
- d. A building wall of an existing or proposed building may serve as a partial element of the screening enclosure, provided that the building wall meets the height requirements outlined in Sec. 4C.12.C.2.a. and the opacity requirements outlined in Sec. 4C.12.C.2.b.
- e. Areas within the screening enclosure shall be maintained free of trash and debris.
- f. Screening enclosure shall comply with Sec. 4C.7.3 (*Fence/Wall Design & Installation*).
- g. Screening may need to comply with additional access and clearance standards as may be required by LADWP.

3. Landscape Screen

Plants and landscaping used meet ground mounted equipment screening requirements shall meet the following standards:

a. General

- i. Landscape screens shall be composed of hedges meeting the requirements of *Sec. 4C.12.2.C.3.b. (Hedges)* or screening plants meeting the requirements of *Sec. 4C.12.2.C.3.c. (Screening Plants)*. Landscape screens may be composed of a combination of screening plants and hedges.
- ii. All required screening plants and hedges shall have a minimum height at maturity no lower than the height of the topmost point of the equipment subject to screening.
- iii. All required screening plants and hedges shall comply with *Sec. 4C.6.4. (Plant Design and Installation)*.
- iv. Areas within the landscape screen shall be maintained free of trash and debris.
- v. All plants provided in a landscape screen shall be planted and maintained so as to ensure a minimum of 3 feet of clearance between all portions of the equipment and the plants, based on spread at maturity.
- vi. Screening may need to comply with additional access and clearance standards as may be required by LADWP

b. Hedges

- i. A continuous perimeter of hedge shall surround 100% of the subject equipment. A maximum gap of 3 feet breaking the continuous perimeter is permitted to allow for equipment access, provided that the access gap does not face a frontage lot line.
- ii. Hedges shall meet the requirements of *Sec.4C.6.4.C.3.d. (Hedges)*.

c. Screening Plants

- i. Screening plants shall be planted in a planting area no less than 3 feet in depth that creates a contiguous perimeter surrounding 100% of the subject equipment. A maximum gap of 3 feet breaking the contiguous perimeter is permitted to allow for equipment access, provided that the access gap does not face a frontage lot line.
- ii. A minimum of 20 screening plants shall be planted for every 50 linear feet of planting area, measured at the outside perimeter of the planting area.
- iii. Screening plants shall meet the requirements of *Sec.4C.6.4.C.3.b. (Screening Plants)*.

D. Measurement

- 1. For measurement of opacity see *Sec. 14.1.13. (Opacity %)*.
- 2. For measurement of enclosure see *Sec. 14.1.4. (Enclosure)*.
- 3. Height from topmost point of the equipment is measured to the top of the screen and gate at their lowest point.

- Site Elements -

4. For measurement of plant and hedge height at maturity, see *Sec. 4C.6.4.D.11, (Height at Maturity)*.
5. For measurement of plant and hedge spread at maturity, see *Sec.4C.6.4.D.3. (Canopy Diameter, Spread, and Height at Maturity)*.
6. For measurement of planting area width, see *Sec. 4C.6.4.D.1. (Planting Area Width)*.
7. For measurement of parking setback see *Sec. 3C.2.1.D. (Measurement, Parking Setback)*.
8. For measurement of building width see *Sec 2C.6.1.D. (Building Width)*.

E. Relief

1. Where Los Angeles Department of Water and Power determines that utility equipment must be located in the frontage yard and that locating the equipment in a below grade vault is infeasible for reasons not related to cost, the applicant may request an alternative to the ground-mounted equipment location standards in accordance with *Sec. 13B.5.2 (Alternative Compliance)* allowing for the utility equipment to be located above-grade and in a frontage yard.
2. A deviation from any ground-mounted equipment screening dimensional standard of up to 15% may be requested in accordance with *Sec. 13B.5.2 (Adjustment)*.
3. Deviation from any ground-mounted equipment screening standard may be allowed as a variance in accordance with *Sec. 13B.5.3 (Variance)*.

SEC. 4C.12.3. **WALL-MOUNTED EQUIPMENT**

A. **Intent**

To ensure wall-mounted equipment is concealed to minimize effects on the public realm.

B. **Applicability**

Wall mounted equipment standards apply to all mechanical or utility equipment attached to the exterior wall of a building or structure, with the exceptions of wireless telecommunication uses. Wireless telecommunication uses shall meet the screening requirements outlined in Sec. 4C.8.8. (*Wireless Telecommunication Facilities*). Wall-Mounted Equipment standards do not apply to fire alarms.

C. **Standards**

1. **Location**

Wall-mounted electrical meters, gas meters, cable boxes and other utility equipment shall not be attached to a building facade facing a frontage yard and shall not be located in a frontage yard unless it is fully screened with a screening enclosure meeting the standards below and that screening enclosure complies with the frontage yard fences and walls type standards allowed in the applicable Frontage District.

2. **Screening Enclosure**

Wall-mounted equipment located on a building or structure facade abutting a frontage yard shall be screened with an enclosure that meets the following requirements:

- a. Has a minimum of 75% enclosure for a height of at least 6 inches taller than the topmost point of the equipment. For wall mounted equipment located more than 3 feet above the base of the wall, the enclosure shall have a minimum of 75% enclosure for no less than 6 inches below the bottommost point of the equipment.
- b. Has a minimum opacity of 75%.
- c. Access gates provided in the screening enclosure shall meet the following standards:
 - i. Shall have a height no less than 6 inches taller than the topmost point of the equipment and, where located more than 3 feet above the base of the wall, shall continue no less than 6 inches below the bottommost point of the equipment.
 - ii. Where a screening structure is taller than the minimum height, gates may differ no more than 1 foot from the height of the wall or fence provided.
 - iii. In no case shall gates exceed the height of the screening structure by more than 1 foot.
 - iv. Has a minimum opacity of 90%.

- d. The screening structure shall comply with *Sec. 4C.7.3 (Fence/Wall Design & Installation)*.

D. Measurement

1. For measurement of opacity see *Sec. 14.1.13. (Opacity %)*.
2. For measurement of enclosure see *Sec. 14.1.4. (Enclosure)*.
3. Height from topmost point of the equipment is measured to the top of the screen and gate at their lowest height.

E. Exceptions

[Reserved]

F. Relief

1. An alternative to wall-mounted equipment screening standards may be requested in accordance with *Sec. 13B.5.1 (Alternative Compliance)*.
2. A deviation from any wall-mounted equipment screening dimensional standard of up to 10% may be requested in accordance with *Sec. 13B.5.2 (Adjustment)*.
3. Deviation from any wall-mounted equipment screening standard may be allowed as a variance in accordance with *Sec. 13B.5.3 (Variance)*.

SEC. 4C.12.4. **WIRELESS TELECOMMUNICATION FACILITIES**

A. **Intent**

To minimize visual impacts, make the installation, operation, and appearance of wireless telecommunication facilities as inconspicuous as possible, to prevent the facility from visually dominating the surrounding area, and to hide the installation from predominant views from surrounding properties.

B. **Applicability**

All wireless telecommunications uses, excluding satellite dish antennae, radio, and television transmitters and antennae incidental to residential uses.

C. **Standards**

Wireless telecommunications facilities shall meet the following screening design standards. Specific screening and design requirements depend on the proposed site and surroundings based on discretionary review by the approving authority.

1. **General**

- a. All wireless telecommunications facilities shall meet the minimum siting distances to habitable structures required for compliance with Federal Communications Commission (FCC) regulations and standards governing the environmental effects of radio frequency emissions.
- b. New wireless telecommunication equipment shall be installed at an approved existing facility, when co-location is feasible.
- c. Existing rooftop facilities in which new wireless telecommunication equipment is installed shall be subject to the standards included in Sec. 4C.8.8.C.2.
- d. Existing monopole facilities in which new wireless telecommunication equipment is installed shall be subject to the standards included in Sec. 4C.8.8.C.3.

2. **Rooftop Wireless Telecommunications Facilities**

Rooftop wireless telecommunications facilities, including antennas and any associated equipment shall meet the following standards:

- a. Rooftop Wireless Telecommunications facilities are only allowed where they are a permitted use in the applied *Use District (Part 5B)*.
- b. Where located on the rooftop of a designated historic resource or a surveyed historic resource rooftop Wireless Telecommunications facilities require review and approval pursuant to Sec. 13B.2.2. (Class 2 Conditional Use Permit).
- c. Shall be located on rooftops no less than 40 feet above grade.

- d. Shall be screened on all sides by a parapet or screening enclosure that meet the standards provided in *Sec. 4C.8.5.C (Roof-Mounted Equipment)*.
- e. The structure covering the antenna and any equipment cabinet shall be painted and textured to match the exterior walls of the building.
- f. Any wireless antenna structures and associated equipment shall have a height no greater than 10 feet, measured from rooftop surface at the base of the structures or equipment.
- g. Where mounted on the walls of a rooftop enclosure for mechanical equipment or vertical circulation, wireless antenna structures and associated equipment cabinets shall not exceed the height of the rooftop enclosure.
- h. The cumulative area occupied by all rooftop wireless telecommunications facilities and associated equipment shall not exceed 10% of the total area of the rooftop.

3. **Monopole Installations**

Monopole wireless telecommunications facilities, including antennas and any associated equipment shall meet the following standards:

- a. The footing of a monopole antenna shall be structurally designed to support a monopole which is at least 15 feet higher than the monopole under review, while being within the applicable requirements of the maximum height specified in the applied *Form District (Part 2C)*, in order to allow a future wireless network to replace an existing monopole with a new monopole capable of supporting equipment co-location.
- b. Monopoles shall be set back a minimum distance equal to 20 percent of the monopole height or 35 feet, whichever is greater, from the following lot lines:
 - i. Primary and side street lot lines;
 - ii. Lot lines shared with a lot that includes a sensitive use; and
 - iii. Lot lines shared with a lot that zoned with a residential or agricultural use district.
- c. Monopoles shall be screened on all sides with a planting area meeting the following standards:
 - i. Shall have a minimum width of 5 feet.
 - ii. Shall provide a screening plant at a frequency of 30 per 50 feet of planting area.
 - iii. Shall provide a large species tree at a frequency of 3 per 50 feet of planting area.
- d. All monopole wireless telecommunication facilities shall use surfacing and camouflaging techniques that satisfy the following criteria:
 - i. Exterior colors, textures, and shapes are visually compatible with the surrounding built or natural environment.

- ii. Exterior finish is non-reflective, unless otherwise required by the Federal Aviation Administration
- iii. Shall be situated so as to utilize existing natural or man-made features including topography, vegetation, buildings, or other structures to provide the greatest amount of visual screening.
- e. The approving authority may require additional measures designed to camouflage a monopole wireless telecommunication facility, including placing the facility entirely within a vertical screening structure. Suitable architectural features include, but are not limited to, clock towers, bell towers, church steeples, icon signs, lighthouses, flagpoles or utility poles. All facility components, including the antennas, shall be mounted inside said structure.
- f. Monopoles that are not vertically screened shall be of tapered design (3 foot diameter at the base up to 1.5 foot diameter at the top).
- g. All wireless telecommunication facilities shall be removed within 90 days of discontinuance of use.

D. Measurement

1. Setbacks from Lot Lines are measured according to *Sec. 2C.2.2.D. (Building Setbacks)*.
2. Planting area width is measured according to *Sec. 4C.6.4.D.1. (Planting Area Width)*.
3. Planting frequency is measured according to *Sec. 14.1.8. (Frequency)*.
4. Screening Plants are measured as provided or not provided, based on the presence of screening plants that comply with *Sec. 4C.6.4.C.3.b. (Screening Plants)* and all other applicable provisions of *Sec. 4C.6.4. (Plant Design and Installation)*.
5. Large species trees are measured as provided or not provided, based on the presence of large species trees that comply with *Sec. 4C.6.4.C.3.a. (Trees)* and all other applicable provisions of *Sec. 4C.6.4. (Plant Design and Installation)*.

E. Relief

1. An alternative to wireless telecommunication facilities standards may be requested in accordance with *Sec. 13B.5.1 (Alternative Compliance)*.
2. A deviation from any wireless telecommunication facilities dimensional standard of up to 10% may be requested in accordance with *Sec. 13B.5.2 (Adjustment)*.
3. Deviation from any wireless telecommunication facilities standard may be allowed as a variance in accordance with *Sec. 13B.5.3 (Variance)*.

SEC. 4C.12.5. WASTE RECEPTACLES

A. Intent

To ensure waste receptacle service areas are designed in a manner that does not detract from the safety, comfort, or enjoyment of users of the lot, neighboring lots or the public realm.

B. Applicability

1. All solid waste, recycling, and organic waste receptacles 96 gallon in size or greater stored on a lot, with the exception of lots containing only residential uses and 4 or fewer dwelling units.
2. Use modification project activities on a site having less than 2,500 square feet of lot area shall be exempt from waste receptacle screening and enclosure standards.

C. Standards

1. Location

- a. Waste receptacles and their screening enclosures shall not be located in a frontage yard.
- b. Waste receptacles may be located within a building or structure provided they are located in a room with 100% enclosure.
- c. Waste receptacles may be located in the same area, room, or enclosure as required recycling areas as long as the area, room, or enclosure meets both the *waste receptacle standards* (Sec. 4C.9.5.) and the recycling areas standards outlined in Sec. 4C.12.6. (*Recycling Areas*).
- d. Waste receptacle storage areas shall be made accessible to the public right of way, a driveway, or a motor vehicle use area through a pedestrian accessway with a minimum width of 4 feet in order to accommodate waste hauling services.

2. Screening Enclosure

The outdoor waste receptacle shall be screened with an enclosure that meets the following requirements:

- a. Has 100% enclosure for a minimum height of 6 feet , but no less than 1 foot taller than the height of the waste receptacles the facility is designed to enclose.
- b. Has a minimum opacity of 90%.

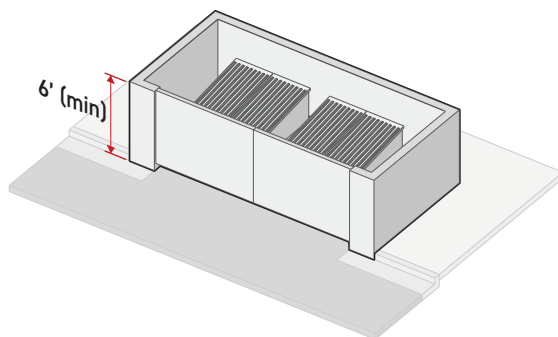

- c. Outdoor waste receptacle enclosures located on a lot zoned with a Residential or Agricultural Use Uistrict or located on a lot abutting a Residential or Agricultural use district shall be sheltered. The sheltering structure shall meet the following standards:
 - i. Shall have a slope of no less than 5 degrees;
 - ii. Shall be and made of non pervious material to ensure runoff; and
 - iii. Shall provide a minimum clear height of 8 feet under the structure.
- d. Wheel stops with a minimum height of 8 inches shall be installed a minimum of 6 inches from interior walls of waste receptacle enclosures to prevent damage to walls.
- e. Access gates provided in the screening enclosure shall meet the following standards:
 - i. Shall have a height of no less than 6 feet.
 - ii. Where a screening structure is 7 feet or greater in height, gates may be no more than 1 foot shorter than th height of the screening enclosure provided.
 - iii. In no case shall gates exceed the height of the screening structure by more than 1 foot.
 - iv. Has a minimum opacity of 90%.
- f. All provided screening enclosures shall comply with *Sec. 4C.7.3 (Fence/Wall Design & Installation)*.

D. Measurement

1. For frontage yard designation see *Sec. 14.1.16.G. (Frontage Yard)*.
2. For measurement of height see *Sec. 4C.7.1.D.1 (Fence and Wall Height)*.
3. For measurement of enclosure see *Sec. 14.1.4. (Enclosure)*.
4. For measurement of opacity see *Sec. 14.1.13. (Opacity %)*.

E. Relief

1. An alternative to waste receptacle standards may be requested in accordance with *Sec. 13B.5.1 (Alternative Compliance)*.
2. A deviation from any waste receptacle dimensional standard of up to 15% may be requested in accordance with *Sec. 13B.5.2 (Adjustment)*.
3. Deviation from any waste receptacle standard may be allowed as a variance in accordance with *Sec. 13B.5.3 (Variance)*.

SEC. 4C.12.6. **RECYCLING AREAS**

An outdoor enclosure or a room within a building which is designated for the collection of recyclable materials generated by the use(s) on a lot.

A. Intent

To ensure that adequate facilities for collecting and loading recyclable materials are provided in order to divert solid waste, address source reduction, and facilitate recycling and composting activities by users, tenants, and residents.

B. Applicability

1. Recycling areas standards apply to projects involving new construction resulting in:
 - a. A 25% increase in floor area for residential projects with four or more dwelling units; or
 - b. a 30% increase of floor area for non-residential projects. For marinas, floor area includes the space dedicated to the docking or mooring of marine vessels
2. Any site where multiple building permits are issued within a 12-month period that result in the addition of floor area beyond the above thresholds is also required to meet the recycling areas standards.

C. Standards

1. General

- a. Recycling areas shall be equipped with recycling receptacle containers that are covered, durable, waterproof, rustproof, and of incombustible construction, and that either provide protection against the environment or are located in a building or structure that is covered and enclosed. Containers must be clearly labeled to indicate the type of material to be deposited, and all recyclable materials must be placed or stored in such containers.
- b. When a project provides a trash chute, including adding a trash chute to an existing development, a recycling chute shall also be provided. Recycling chutes shall be clearly marked "recycling only" at every point of entry.
- c. Outdoor recycling areas shall be constructed with a concrete floor sloped to drain, and a water faucet for hose attachment shall be located adjacent to or within the enclosure.
- d. The recycling area shall be clearly identified by one or more signs with a minimum dimension of 16 inches by 20 inches that designate the area for recycling collection and loading;
- e. The recycling area shall be available for use by persons residing or employed on the property

- f. No payment shall be made to persons depositing recycling materials in the recycling area and no processing of recycling materials shall be permitted within the recycling area. For recyclable materials deposited or redeemed for monetary value, see Sec.5C.1.8.D.1. (Recycling Facility, Collection). For sorting or processing of recyclable materials from off-site sources, see Sec.5C.1.8.D.3. (Recycling Facility, Sorting & Processing).
- g. Each property owner or lessee shall contract with a recycler or hauler for the pick-up of recyclable materials, separate from trash collection, when receptacles are full or every week, whichever occurs first.
- h. To encourage active participation in recycling to the maximum extent possible, each property owner, manager, or lessee shall inform all tenants and/or employees living or working on the property of the availability and location of the recycling area(s), the types of materials that are collected for recycling, and that the recycling collection facilities are located on the property pursuant to state law requiring the diversion of a substantial portion of solid waste.
- i. No toxic or hazardous material shall be stored in recycling areas or receptacles;
- j. Recycling areas shall be kept free of litter, debris, spillage, bugs, rodents, odors, and other similar undesirable hazards.

2. Location

- a. Outdoor recycling areas and their screening enclosures shall not be located in a frontage yard.
- b. Recycling areas may be located within a building or structure provided they have 100% enclosure.
- c. Recycling areas shall be placed within 10 feet of waste receptacles or waste receptacle service areas or rooms wherever feasible. Where multiple recycling areas are provided, at least one recycling area must be placed within 10 feet of at least one waste receptacle or waste receptacle service area or room.
- d. Recycling areas may be located in the same area, room, or enclosure as waste receptacles as long as the area, room, or enclosure meets both the recycling area standards and the waste receptacle standards outlined in Sec. 4C.12.5. (Waste Receptacles).
- e. Recycling areas shall not diminish the required number of automobile parking stalls or bicycle parking spaces or impair traffic flow.

3. Size

- a. For residential uses with 20 or fewer dwelling units or any other uses with a total floor area of less than 3,000 square feet, the minimum area of the required recycling area shall be 30 square feet;

- Site Elements -

- b. For residential uses of 21 to 50 dwelling units or any other uses having a total floor area of 3,001 to 7,500 square feet, the minimum area of the required recycling area shall be 60 square feet;
- c. For residential uses of 51 or more dwelling units, or any other uses having a total floor area of greater than 7,500 square feet, the minimum area of the required recycling room shall be 100 square feet;
- d. No individual area recycling area shall exceed an area of 300 square feet.
- e. Multiple recycling areas on the same lot may be combined to meet the applicable required minimum area, as long as no individual recycling area has an area of less than 30 feet and the total combined area of the provided recycling areas does not exceed 300 square feet.
- f. Every recycling area shall contain a minimum clear height at least eight feet.
- g. The recycling area shall be of adequate size for the collection of all recyclable materials generated by the use(s) occupying the site, without such materials overflowing the area or forcing significant amounts of recycling to be discarded as general refuse. If the Department of Building and Safety determines the proposed recycling area to be inadequate, they may require a larger space, even if the proposed area exceeds the minimum requirements listed in Sec. 4C. 12.C.3.a-c. (Size) above.

4. Screening Enclosure

Outdoor recycling areas shall be screened with an enclosure that meets the following requirements:

- a. Has 100% enclosure for a minimum height of 6 feet.
- b. Has a minimum opacity of 90%.

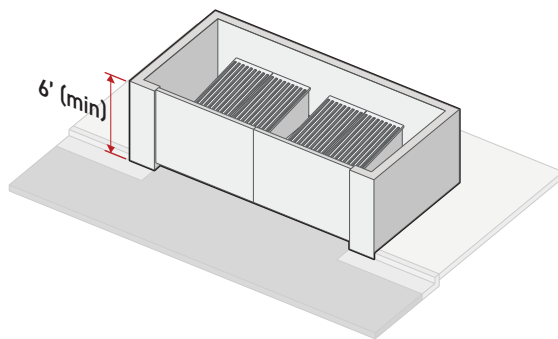

- c. Access gates provided in the screening enclosure shall meet the following standards:
 - i. Shall have a height of no less than 6 feet.
 - ii. Where a screening structure is 7 feet or greater in height, gates may be no more than 1 foot shorter than the height of the screening enclosure provided.

- iii. In no case shall gates exceed the height of the screening structure by more than 1 foot.
- iv. Has a minimum opacity of 90%.
- d. All provided screening enclosures shall comply with Sec. 4C.7.3 (Fence/Wall Design & Installation).

D. Measurement

- 1. For frontage yard designation see *Sec. 14.1.16.G. (Frontage Yard)*.
- 2. For measurement of height see *Sec. 4C.7.1.D.1 (Fence and Wall Height)*.
- 3. For measurement of enclosure see *Sec. 14.1.4. (Enclosure)*.
- 4. For measurement of opacity see *Sec. 14.1.13. (Opacity %)*.

E. Relief

- 1. An alternative to recycling receptacle standards may be requested in accordance with *Sec. 13B.5.1 (Alternative Compliance)*.
- 2. A deviation from any recycling receptacle dimensional standard of up to 15% may be requested in accordance with *Sec. 13B.5.2 (Adjustment)*.
- 3. Deviation from any recycling receptacle standard may be allowed as a variance in accordance with *Sec. 13B.5.3 (Variance)*.

SEC. 4C.12.7. **SHOPPING CART CONTAINMENT**

A. **Intent**

To prevent or reduce the accumulation of abandoned shopping carts in the City, which may obstruct pedestrian and vehicular traffic, and constitute a hazard to the health, safety, and general welfare of the public.

B. **Applicability**

Shopping cart containment requirements apply to projects involving new construction, site modification, use modification, and major renovation for commercial uses established in Sec. 5C.1.5. (*General Commercial Uses*) that provide six or more shopping carts.

C. **Standards**

1. **General**

a. **Shopping Cart Noticing**

Every shopping cart owned or provided by any business establishment in the City must have a notice permanently affixed to it that:

- i. Identifies the owner of the cart or the name of the business establishment, or both.
- ii. Notifies the public of the procedure to be utilized for authorized removal of the cart from the business premises.
- iii. Notifies the public that the unauthorized removal of the cart from the premises or parking area of the business establishment is a violation of State and City law.
- iv. Lists a telephone number to contact to report the location of the abandoned cart.
- v. Lists an address for returning the cart to the owner or business establishment.

b. **Shopping Cart Collection Areas**

Shopping cart corrals and/or storage areas shall be provided with a minimum width of 5 feet and minimum depth of 15 feet, but shall not be located within a required frontage yard.

c. **Signs**

Signs that warn customers that shopping cart removal is prohibited and constitutes a violation of *Sec. 22435.1. of the California Business and Professions Code* and *Sec. 41.45. of Chapter 4 (Public Welfare) of the LAMC* shall be installed and maintained at exits, shopping cart collection areas, and any vehicular or pedestrian accessways. Signs shall be no less than 16 inches by 20 inches, and placed at a minimum height of 3 feet and a maximum height of 6 feet.

2. Containment Methods

A project shall include a practical containment approach with one or more of the following containment methods to ensure that shopping carts remain on the premises.

a. Wheel Locking or Stopping Mechanisms

Shopping carts shall be equipped with a wheel locking or stopping mechanism that is used in conjunction with an electronic magnetic barrier along the perimeter of the commercial use or lot, including customer entrances, loading areas, basements, landscaped areas, along crossings and access points required for driveways, drive aisles, pedestrian accessways, and pedestrian passageways, or any other perimeter identified on a shopping cart containment plan. The wheel locking or stopping mechanism must activate when the shopping cart crosses the electronic or magnetic barrier.

b. Screening Plants

A type F1 frontage screen, in accordance with *Sec. 4C.8.1.C.2.a. (F-Screen 1)*, shall be provided along the perimeter of the commercial use or lot, or any other perimeter identified on a shopping cart containment plan.

c. Bollards

Bollards shall be installed at customer entrances, or within 10 feet of the entrances, and shall be spaced at a maximum distance of 17 inches from each other or nearby enclosed space.

d. Other Methods

Other methods for shopping cart containment so long as the Department of Public Works, Bureau of Sanitation, or its successor agency, has approved the system or method which would effectively contain or control shopping carts on the premises.

3. Performance Standards

Applicants shall execute and record a covenant and agreement to the satisfaction of the Department of Public Works, Bureau of Sanitation, meeting the following standards:

a. Daily After Hours Cart Containment

A plan for securing shopping carts whenever the store is not open for business shall be provided.

b. Shopping Cart Retrieval

The owner shall be responsible for retrieving their own carts or provide evidence of a contract with a shopping cart retrieval service with terms requiring collection of abandoned shopping carts within 24 hours of notification of an abandoned shopping cart.

c. Employee Training

The owner of the retail establishment shall implement and maintain a periodic training program for its new and existing employees designed to educate employees about the abandonment and retrieval of shopping carts from the premises of the retail establishment.

D. Measurement

1. Shopping Cart Containment Plan

A shopping cart containment plan shall be prepared that identifies areas on a lot where shopping carts can be removed from the lot and identifies the proposed containment method for each area.

2. Recorded Agreement

Prior to issuance of a Building Permit, a covenant acceptable to the Department of Public Works, Bureau of Sanitation and consistent with *Sec. 1.3.2.C.6. (Recorded Agreements)* shall be recorded with the Los Angeles County Recorder, guaranteeing that the contaminants methods, general requirements, and performance standards established in this Section are met.

E. Relief

- 1.** A deviation from shopping cart containment standards established in this Section may be requested in accordance with *Sec. 13B.5.1. (Alternative Compliance)*.
- 2.** A deviation from any shopping cart containment dimensional standard of up to 10% may be requested in accordance with *Sec. 13B.5.2 (Adjustment)*.
- 3.** A deviation from any shopping cart containment standard may be allowed as a variance in accordance with *Sec. 13B.5.3 (Variance)*.

F. Enforcement

Regardless of *Div. 13B.10. (Department of Building and Safety)*, the Department of Public Works, Bureau of Sanitation shall have the authority and responsibility to enforce the provisions of this Section.

DIV. 4C.13. **ENVIRONMENTAL PROTECTION**

SEC. 4C.13.1. **ENVIRONMENTAL PROTECTION MEASURES**

A. **Intent**

1. Ensure that development in the City does not result in detrimental impacts to those residing or working in and around construction activities, and to abutting properties, and the public right of way, including the habitat, cultural resources, and historic or fragile buildings.
2. Provide a mechanism for mitigation measures adopted to certify environmental impact reports for City plans, policies, or regulations to be made enforceable on future development projects consistent with *CEQA Guidelines, Section 15162.4*.
3. Provide a flexible mechanism to adopt and amend uniformly applicable development standards to allow streamlined environmental review, including pursuant to *CEQA Guidelines Section 15183.3*.

B. **Applicability**

No permit shall be issued by the Department of Building and Safety without the applicant demonstrating compliance with applicable environmental protection measures.

C. **Adoption and Maintenance of the Environmental Protection Measures**

The Director of Planning, as they deem necessary and appropriate, shall have the authority to prepare, maintain, amend, and adopt the environmental protection measures. The Director of Planning may, as they deem appropriate, use technical consultants or a consultant advisory panel to make recommendations on new environmental protection measures or updates to existing environmental protection measures.

D. **Noncompliance**

Failure to comply with the environmental protection measures or any condition or commitments made in compliance with the environmental protection measures is a violation of the Code, subject to all available administrative, criminal and civil remedies. Additionally, upon confirmation of non-compliance, the Director of Planning may require as deemed necessary and appropriate the applicant or property owner to retain at its own expense an independent consultant, subject to the Director of Planning's approval, to ensure compliance with the environmental protection measures and any conditions or commitments made in compliance with the environmental protection measures.

DIV. 4C.14. **DEVELOPMENT REVIEW**

SEC. 4C.14.1. **DEVELOPMENT REVIEW THRESHOLD PACKAGES**

A. **Intent**

To require the discretionary review of development projects when certain thresholds are met, and to allow for variation in these thresholds appropriate to the context of development.

Applicability

Individual projects and related or successive project activities which are determined by the Director to be part of a larger project, meeting a condition specified in either *development review threshold package 1 (Sec. 4C.14.1.C.1.)* or *development review threshold package 2 (Sec. 4C.14.1.C.2.)*.

B. **Standards**

1. **Development Review Threshold Package 1**

a. **Project Review Thresholds**

When the applicable *Development Standards District (Part 4B)* specifies development review threshold package 1, the following development projects are subject to Sec. 13B.2.4. (*Project Review*):

- i. Any development project which creates, or results in an increase of, 50,000 square feet or more of nonresidential floor area.
- ii. Any development project which creates, or results in an increase of, 50 or more dwelling units.
- iii. Any development project that includes drive-through lanes which results in a net increase of 500 or more average daily trips.
- iv. Any change of use which results in a net increase of 1,000 or more average daily trips.
- v. Any one unit development with a floor area of 17,500 square feet or larger located in the Hillside Area Map (Sec. 1.4.4).

b. **Major Development Project Review Thresholds**

When the applied *Development Standards District (Part 4B)* specifies Development Review Threshold Package 1, development projects having one or more of the characteristics listed below are subject to Sec. 4C.14.C.3. (*Supplemental Procedure*):

- i. Any development project that creates or results in an increase of 250,000 square feet or more of warehouse floor area.

- ii. Any development project that creates or results in an increase of 250 or more lodging units.
- iii. Any development project that creates or results in an increase of 100,000 square feet or more of floor area in other non-residential or non-warehouse uses.

2. Development Review Threshold Package 2

a. Project Review Thresholds

When the applicable *Development Standards District (Part 4B)* specifies development review threshold package 2, development projects participating in the *community benefits program (Div. 9.3.)* having one or more of the characteristics listed below are subject to *Sec. 13B.2.4. (Project Review)*. Any development project that is not participating in the community benefits program is subject to development review threshold package 1:

- i. Any development project including a building or structure having a height of 500 feet or taller.
- ii. Any development project which adds at least 500,000 square feet of nonresidential floor area.
- iii. Any development project which adds at least 500 dwelling units.
- iv. Any development project that includes drive-through lanes which results in a net increase of 500 or more average daily trips.
- v. Any change of use which results in a net increase of 1,000 or more average daily trips.
- vi. Any one unit development with a floor area of 17,500 square feet or larger located in the Hillside Area Map (Sec. 1.4.4).

b. Major Development Project Review Thresholds

When the applied *Development Standards District (Part 4B)* specifies Development Review Threshold Package 2, no development projects participating in the *Community Benefits Program (Div. 9.3.)* are subject to the review process outlined in *Sec. 4C.14.C.3.(Supplemental Procedure)*. Any development project that is not participating in the community benefits program is subject to Development Review Threshold Package 1, including the review process and review thresholds outlined in *Sec. 4C.14.C.1.b. (Major Development Project Review Thresholds)* and the review thresholds outlined in *Sec. 4C.14.C.3. (Supplemental Procedure)*

3. Supplemental Procedure

Development projects meeting the thresholds outlined in *Sec. 4C.14.C.1.b. (Major Development Project Review Thresholds)*, shall use an alternative project review approval process. These projects are subject to the process outlined in *Sec. 13B.2.4. (Project Review)*; however, development approval decisions shall be appealed to the City Planning Commission,

rather than the Area Planning Commission, as described in Sec. 13B.2.4. (Project Review). Additionally, if the Director of Planning fails to make a decision on an application within the time limit specified in Sec. 13B.2.4. (Project Review), the applicant may file a request for transfer of jurisdiction to the City Planning Commission pursuant to Sec. 13.2.6. (Transfer of Jurisdiction), rather than a transfer of jurisdiction to the Area Planning Commission.

C. **Measurement**

1. For calculating floor area see *Sec. 14.1.7. (Floor Area)*.
2. Average daily trips are determined by, and using the trip generation factors promulgatd the Department of Transportation.
3. For building height in feet see *Sec. 2C.4.2.D. (Height in Feet)*.

D. **Relief**

None.