

EXHIBIT D.1: Downtown Community Plan Implementation Overlay (CPIO)

Downtown Community Plan

CF 22-0617; CPC-2017-432-CPU; CPC-2014-1582-CA; ENV-2017-433-EIR

Recommended by the City Planning Commission on September 23, 2021

September 2022

Downtown Community Plan Implementation Overlay District (Downtown CPIO District)

Ordinance No. _____
Effective Date XXXXX

TABLE OF CONTENTS

Chapter I	Function of the CPIO District
Chapter II	Community Benefits Program Subarea A
Chapter III	Bunker Hill Subarea B
Chapter IV	Civic Center Subarea C
Chapter V	Historic Resources Subarea D
Appendix A	Environmental Standards (Reserved)
Appendix B	Tall Buildings Best Practices
Appendix C	Historic Cultural Neighborhoods Best Practices
Appendix D	Public Realm Best Practices
Appendix E	Downtown Street Standards

Downtown CPIO District

CHAPTER I – FUNCTION OF THE CPIO DISTRICT

I-I. Section I-1. DOWNTOWN CPIO DISTRICT AUTHORITY AND BOUNDARIES

Pursuant to Los Angeles Municipal Code (LAMC) Chapter 1A Section 8.2.2, the City Council establishes the Downtown Community Plan Implementation Overlay District (Downtown CPIO District). The boundaries of the Downtown CPIO District are identical to the boundaries of the Downtown Community Plan.

Downtown CPIO District

Figure 1-1. Downtown Community Plan Implementation Overlay District Community Benefits Program Subarea A

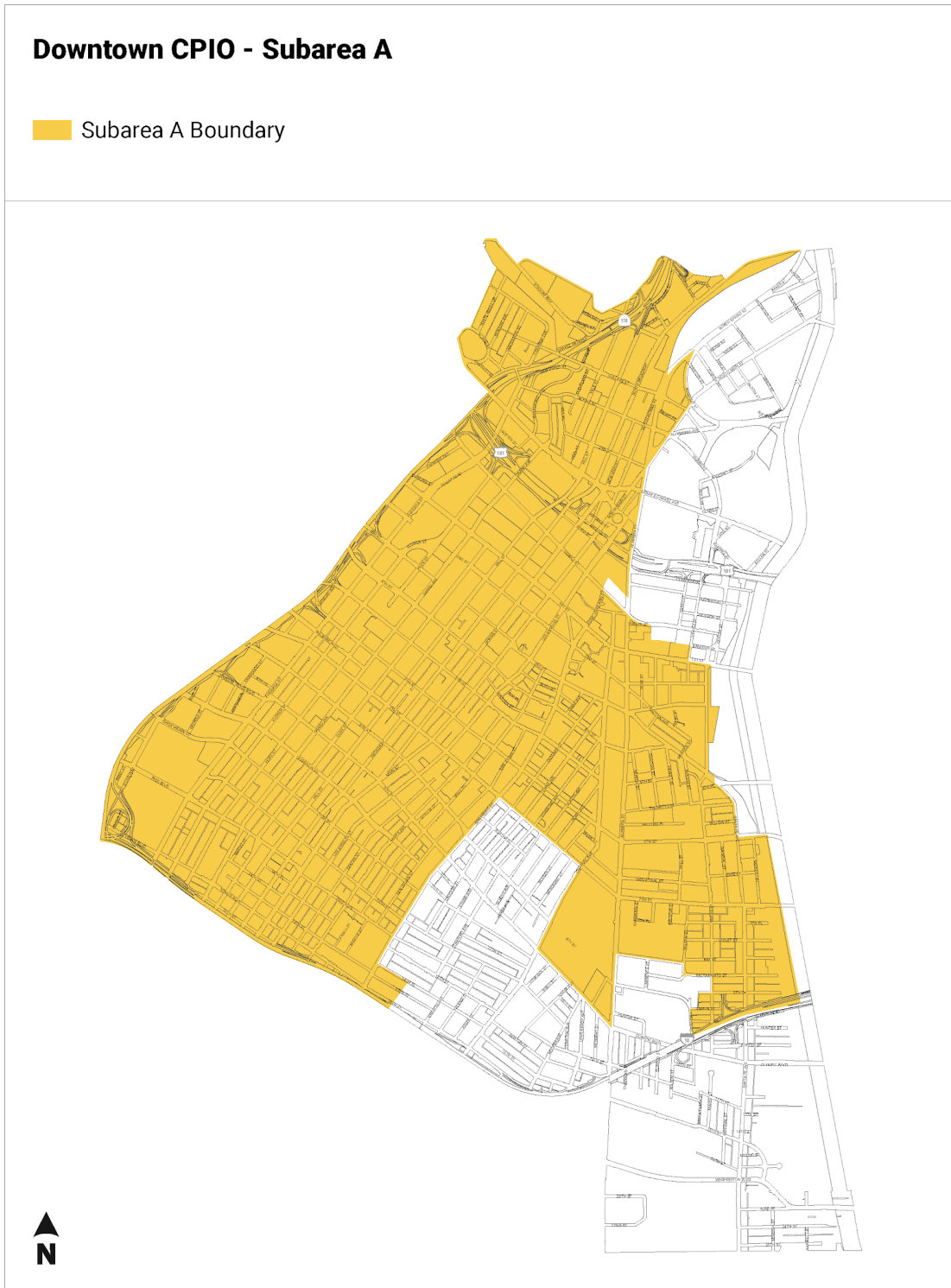

Figure 1-2. Downtown Community Plan Implementation Overlay Bunker Hill Subarea B

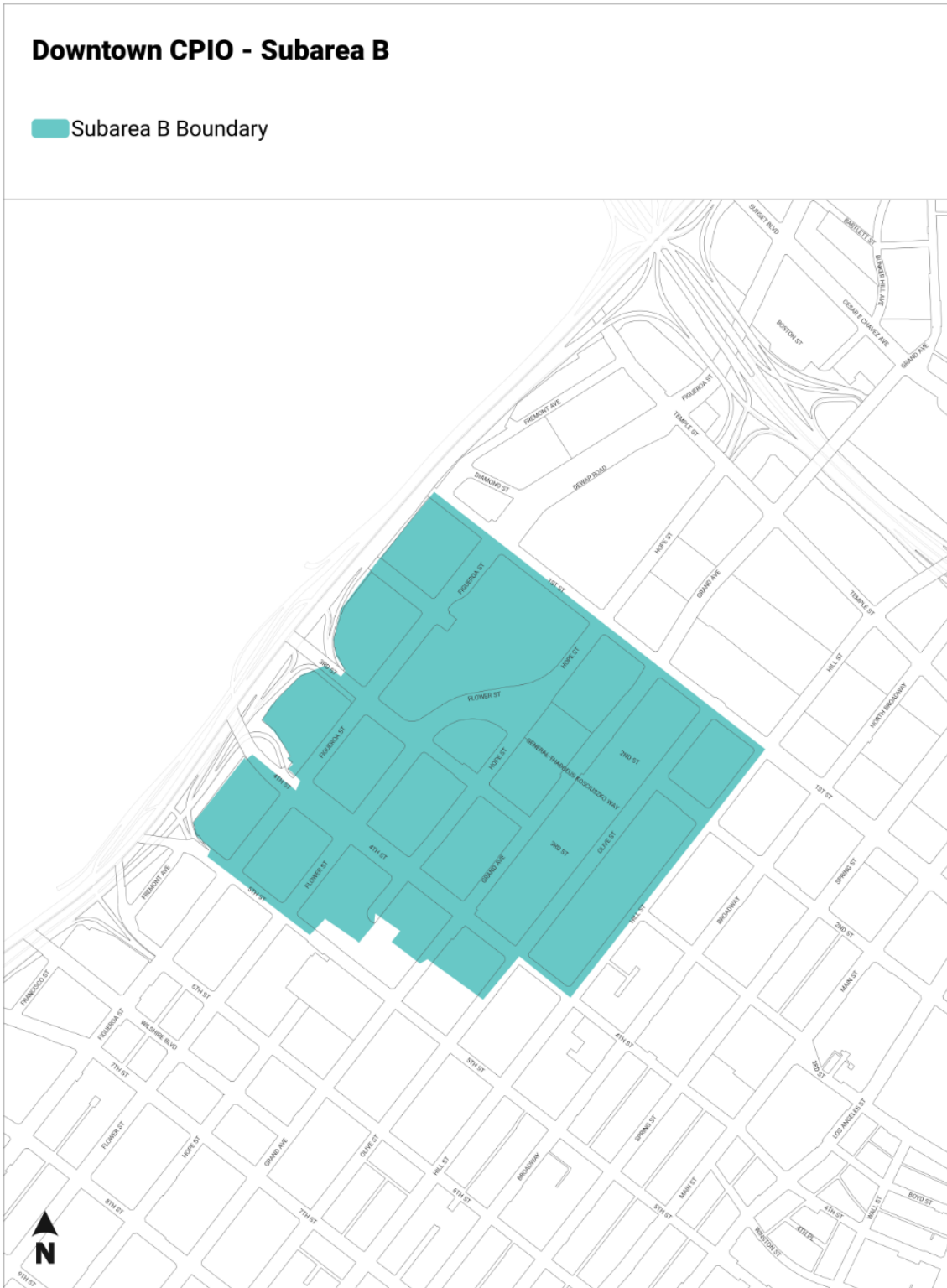

Figure 1-3. Downtown Community Plan Implementation Overlay Civic Center Subarea C

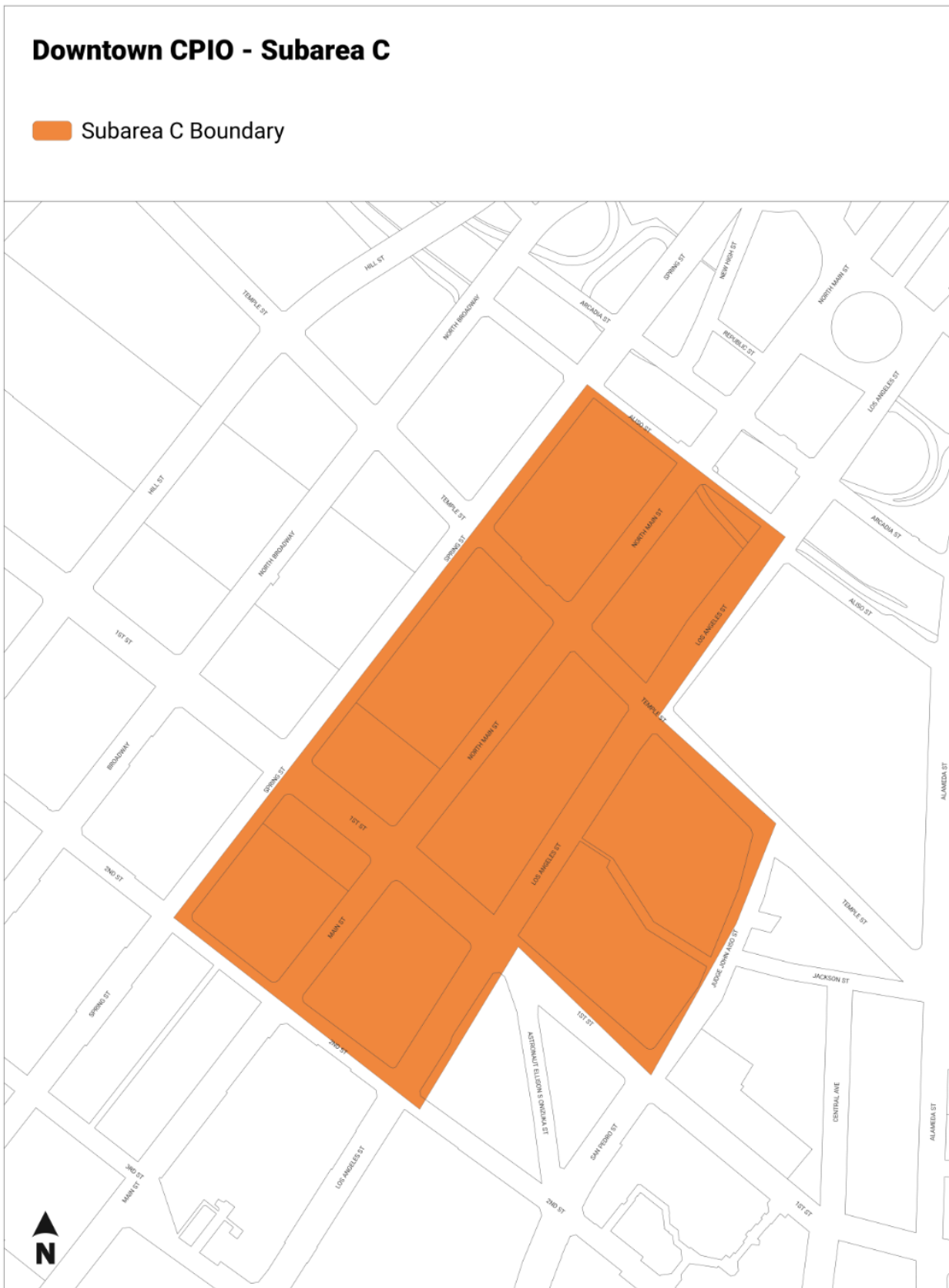
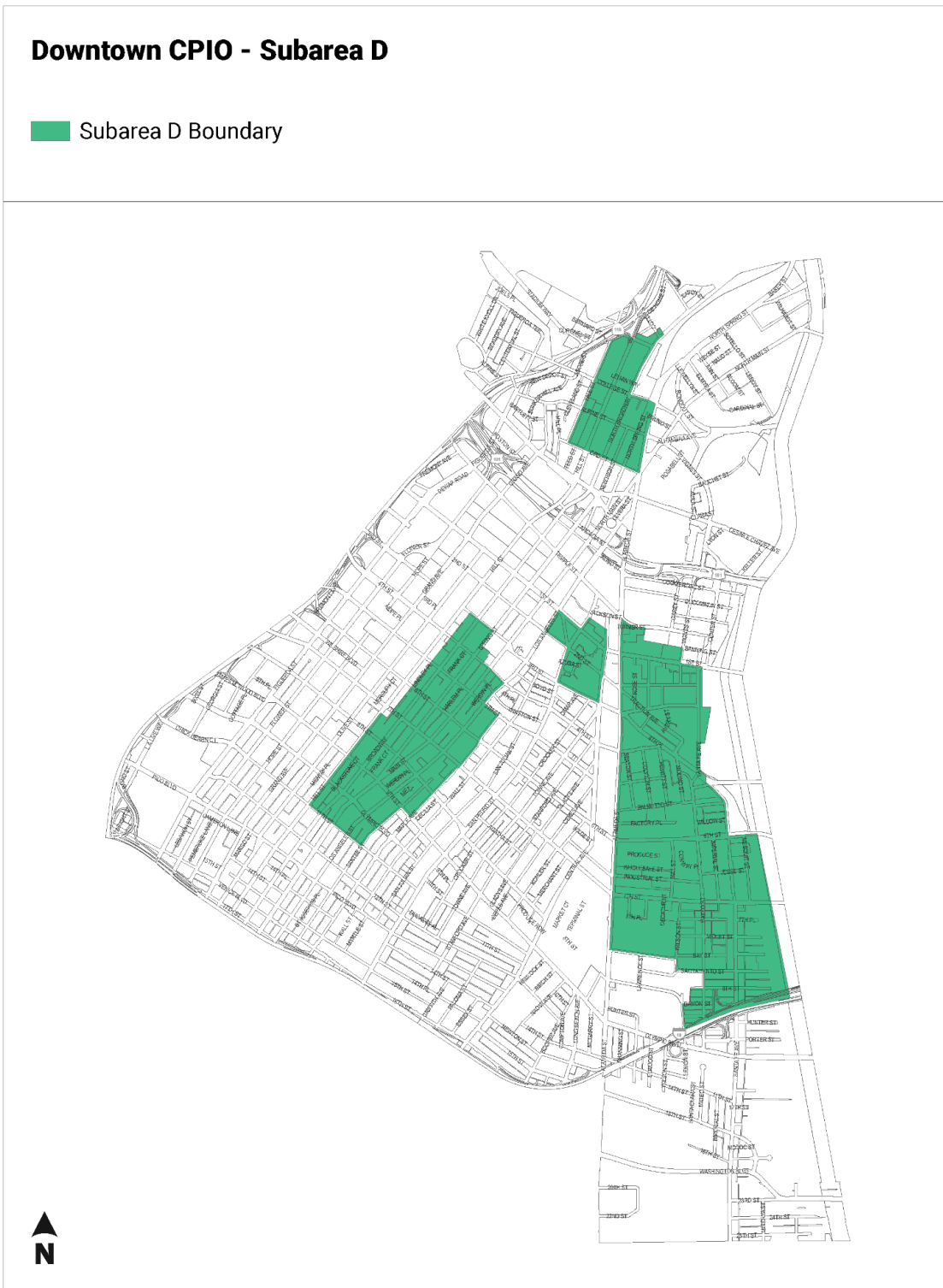

Figure 1-4. Downtown Community Plan Implementation Overlay Historic Preservation Subarea D



I –II. Section I-2. PURPOSE

The purposes of the Downtown CPIO District are as follows:

- A.** To implement the goals and policies of the Downtown Community Plan.
- B.** To create building floor area and height incentives tailored to the neighborhood context and development patterns.
- C.** To encourage housing that is affordable to a variety of income levels and household types.
- D.** To create approval processes for development projects that enable infill development with positive community impacts.
- E.** To promote access to public open space and community facilities that meet the needs of the community.
- F.** To promote the overall health and sustainability of the community that resides, works, and recreates in the Community Plan Area.
- G.** To preserve and protect neighborhood identity, including protecting cultural and historic resources and distinctive character defining elements of existing urban form.
- H.** To promote strong urban design and ensure that development enhances the aesthetic character of the community; and maintains appropriate land uses.

I –III. Section I-3. SUBAREAS

The Downtown CPIO District contains four Subareas as shown on Figures 1-1 through 1-4. The Subareas are contiguous or non-contiguous parcels characterized by common overarching Community Plan themes, goals, and policies, and are grouped by a common boundary. The Subareas are described below.

Community Benefits Program Subarea A

The Community Benefits Program (CBP) Subarea A strives to introduce more Mixed-income and 100 Percent Affordable housing, provide access to public open space and community facilities, and facilitate the preservation and rehabilitation of historic resources in the Community Plan Area. This Subarea includes a tiered incentive structure that prioritizes Mixed-income and 100 Percent Affordable Housing. Within the Subarea, unique zones tailor the incentives to the surrounding context, offering greater intensities of FAR and height around fixed rail transit stations and bus corridors, and considering the identity of neighborhoods.

Bunker Hill Pedestrian Plan Subarea B

The purpose of Subarea B is to implement the previously adopted Bunker Hill Specific Plan for an integrated network of pedestrian linkages throughout the Bunker Hill area. Subarea B shows the general location of the pedestrian linkages. The network of linkages, and the provisions hereinafter set forth to implement such a network, shall be applicable to all Projects and to all properties within Subarea B.

Civic Center Subarea C

The purpose of Subarea C is to introduce affordable housing, ensure active frontages for commercial uses, and regulate the amount of development across the district and allow for floor area to be transferred between City-owned properties in the Civic Center Master Plan Area to support an active and world-class Civic Center environment.

Historic Resources Subarea D

The purpose of this Subarea, which includes neighborhoods that have an abundance of historically and architecturally significant buildings, is to guide the ongoing maintenance, and rehabilitation of these structures through an additional level of review.

I –IV. Section I-4. DEFINITIONS

"100 Percent Affordable Housing" shall mean a project in which 100 percent of the residential dwelling units, excluding any manager unit(s), are Restricted Affordable Units as defined by the LAMC Chapter 1A.

"At-Risk Affordable Unit" shall mean any residential dwelling unit that receives government assistance under prescribed federal, State, and/or local programs, or any combination of rental assistance and is eligible to convert to market rate due to termination (opt-out) of a rent subsidy contract, prepayment of a subsidized mortgage, or expiration of rental restrictions. These assistance programs include, but are not limited to, Housing Choice Vouchers [formerly Section 8], project-based rental assistance, subsidized mortgage programs (e.g., FHA), or expiring rent/deed restrictions with the use of State or local funding programs, including Community Redevelopment Agency Covenants.

"Community Land Trust" shall mean a California nonprofit corporation that: (1) has no part of its net earnings inuring to the benefit of any member, founder, contributor, or individual; (2) is neither sponsored by, controlled by, nor under the direction of a for-profit organization; (3) has a

corporate membership of adult residents of a particular geographic area as described in the bylaws of the corporation; (4) has a board of directors that: (A) includes a majority of members who are elected by the corporate membership; (B) includes representation by persons occupying and/or leasing any structural improvements on the land; and (C) includes representation by persons residing within the geographic area specified in the bylaws of the corporation who neither lease land from the corporation nor occupy structural improvements controlled by the corporation; (5) acquires and retains parcels of land, primarily for conveyance under long-term ground leases; (6) transfers ownership of many or all of the structural improvements located on such leased parcels to the lessees; and (7) retains a preemptive option to purchase such structural improvements at a price determined by formula that is designed to ensure that the improvements remain affordable to low and moderate income households in perpetuity.

Demolition. Throughout the CPIO, site activities that constitute Demolition are defined and determined by the Department of Building and Safety. For the purpose of implementing Section V-1.B.2.a, site activities that include the removal of building components, such that only exterior walls remain is considered Demolition.

“Eligible Historic Resources” shall mean a building, structure, object, site, landscape, or natural feature identified as an individual resource or as a contributor to a historic district under a local, state or federal designation program; or identified as a contributor to an eligible historic district through SurveyLA (The Los Angeles Historic Resources Survey), or another historical resource survey, completed subsequent to the effective date of the CPIO, and completed by a person meeting the Secretary of the Interior’s Professional Qualification Standards for Historic Preservation and accepted as complete by the Director, in consultation with the Office of Historic Resources (OHR). This term does not include a non-contributor to an eligible historic district.

“Mixed-income Housing” shall mean a project comprising a mix of market-rate and Restricted Affordable Units.

“Project” Within Subarea A, a “Project” shall mean any construction, erection, alteration of, or addition to a structure that would exceed the Base Floor Area and Base Height allowances authorized under the subject site’s Form District.

Within Subarea B, a “Project” shall mean any activity that would affect the operation, location, or vacation of any pedestrian easement subject to Chapter III of this CPIO, including, but not limited to, activities that require the issuance of a building, grading, demolition, or change of use permit; street vacation; or modification to a public easement.

Within Subarea C, a “Project” shall mean any construction, erection, alteration of, or addition to a structure that would exceed the Base Floor Area and Base Height allowances authorized under the subject site’s Form District using the transfer of floor area rights provisions within Subarea C.

Within Subarea D, a “Project” shall mean any activity that requires the issuance of a building, grading, demolition, or change of use permit on any site that is an Eligible Historic Resource, unless the work consists solely of interior work such as tenant improvements or interior rehabilitation/repair.

Within all Subareas, a “Project” shall also mean the demolition of any habitable structure pursuant to Section I-VI.C.4 of this CPIO.

“**Public Benefits**” shall mean improvements, facilities, resources, and services beyond affordable housing for the benefit and enjoyment of the general public, pursuant to LAMC Chapter 1A Section 9.3

“**Rehabilitation**” shall mean the act or process of returning a property to a state of utility, through repair or Alteration, which makes possible an efficient contemporary use while preserving those portions or features of the property which are significant to its Historical, architectural and Cultural values.

“**Restoration**” shall mean the act or process of accurately recovering the form, features and details of a property as it appeared at a particular period of time by means of the removal of later work or by the replacement of missing earlier work.

“**Restricted Affordable Unit**” shall mean a Dwelling Unit for which rental or mortgage amounts are restricted so as to be affordable to and occupied by Deeply Low, Extremely Low, Low, and Moderate households, as determined by the Los Angeles Housing and Community Investment Department or its successor agency.

I –V. Section I-5. RELATIONSHIP TO OTHER ZONING REGULATIONS

- A.** For properties within the boundaries of the Downtown Community Plan, where this CPIO applies, the Citywide Transit Oriented Communities Guidelines (TOC) shall be superseded by the provisions and requirements contained within this ordinance.
- B.** Nothing in the Downtown CPIO District is intended to override or conflict with any regulations in the LAMC or other ordinance establishing a park or Quimby fee or park or open space dedication requirement, including any provisions related to credits or fee and dedication calculations.
- C.** Projects providing Restricted Affordable Units to fully utilize the Affordable Housing Local Incentive Program pursuant to Chapter II, Section 2 or pursuant to the requirements of Chapter IV, Section I shall be considered exempt from the Affordable Housing Linkage Fee.

- D. Nothing in this Downtown CPIO District is intended to override or conflict with any regulations in the LAMC that would otherwise require a Conditional Use Permit.
- E. Nothing in this Downtown CPIO District is intended to override or conflict with any bicycle parking regulations.
- F. Nothing in this Downtown CPIO District is intended to override or conflict with the regulations set forth in LAMC Chapter 1A Section 9.B.1 that provide bonuses, waivers and incentives for certain affordable housing projects.
- G. Nothing in this Downtown CPIO District is intended to override or conflict with the regulations set forth in a Community Design Overlay or Sign District applicable to a subject site.
- H. Any reference to a section of the LAMC made in this CPIO shall be automatically updated in the event that the LAMC is re-numbered, or re-organized.

I –VI. Section I-6. REVIEW PROCEDURES

- A. **Prohibition of Issuance of DBS Permits Prior to CPIO Approval.** The Department of Building and Safety (DBS) shall not issue a permit for any Project as defined in this CPIO within a Downtown CPIO District Subarea (in whole or in part), unless the Project has been reviewed and approved in accordance with this Section I-6.
- B. **Filing Requirements for Multiple Approvals.** When an applicant applies for any discretionary approval for a property located (in whole or in part) in a CPIO District Subarea, the applicant shall also apply for a CPIO Approval pursuant to Subsection C, below. A CPIO Adjustment or a CPIO Exception shall be a project adjustment or project exception for purposes of LAMC Chapter 1A Section 13.6, and shall be processed pursuant to the procedures in LAMC Chapter 1A Section 13.6, if applicable.
- C. **CPIO Approval.** All projects subject to a discretionary approval within a Downtown CPIO District Subarea (in whole or in part), Projects seeking additional development rights within Subarea A, and all projects (ministerial and discretionary) within Subareas C and D shall obtain an Administrative Clearance to demonstrate compliance with the Downtown CPIO District, unless a Director’s Determination is required under subsection C.3. An application for a CPIO Approval shall be reviewed and approved pursuant to LAMC Chapter 1A Section 13.5.1, including as its requirements are modified and supplemented below:
 - 1. **Content of Application for a CPIO Approval.** In addition to any other information or documents required under LAMC Chapter 1A Section 13.5.1, an applicant shall provide, at a minimum, detailed permit drawings and any other exhibits deemed necessary to demonstrate compliance with all applicable provisions of the CPIO

District. Each application submitted for a CPIO Adjustment, or a CPIO Exception shall clearly identify and list all of the adjustments and exceptions requested.

2. Administrative Clearance. In addition to the requirements in LAMC Chapter 1A Section 13.5.1, the following shall apply:

- a. Director Approval.** The Director shall grant an Administrative Clearance after reviewing the Project and determining that it is in compliance with all applicable provisions of the Downtown CPIO District as indicated by a plan stamped by the Department of City Planning.
- b. Non-Appealable Ministerial Approval.** The approval of an Administrative Clearance is not subject to appeal and is not discretionary for purposes of CEQA Guidelines Sections 15060(c)(1) and 15268.
- c. Scope of Review and Non-Conforming Uses.**
 - i.** In reviewing a Project for an Administrative Clearance, the Director shall review the Project for compliance with those regulations that are applicable to the proposed scope of construction or use.
 - ii.** Non-conforming uses shall comply with LAMC Chapter 1A Section 12.6, except as noted in this ordinance.

3. Director's Determination. In addition to the requirements in Section I-6 C.2 above, and LAMC Chapter 1A Section 13.4.5, Projects seeking approval of Bonus FAR by providing Public Benefits under Chapter II-3.A (Transfer of Development Rights); Chapter II-4 B.1.b.i.g (Alternative Open Space Amenities); Chapter II-5 C.1.b.i. (Alternative Social Services); Chapter II-5 C.1.c.i. (Alternative Civic Facilities); Projects subject to Subarea B seeking to provide an alternative easement; and Projects subject to Subarea D shall file for a Director's Determination.

- a. Community Plan Implementation Overlay Director's Determination - Director Authority with Appeals to the Area Planning Commission.** The Director or the Director's designee shall have initial decision-making authority to grant a CPIO Director's Determination, with an appeal to the Area Planning Commission in accordance with the procedures set forth in LAMC Chapter 1A Section 13.4.5
- b. Findings.** The Director's Determination shall include written findings in support of the determination. In order to approve a proposed project pursuant to this subsection, the Director must find that:
 - i.** The project, as approved, is consistent with the purpose and intent of the CPIO and substantially complies with the applicable CPIO regulations;

- ii. Conditions have been incorporated into the Determination that will ensure the ongoing use or operation of the Public Benefit.
- iii. The facilities proposed by a project utilizing a Public Benefit Program under Chapter II-4 B.1.b.i.g (Alternative Open Space Amenities), Chapter II-5 C.1.b.i. (Alternative Social Services), or Chapter II-5 C.1.c.i. (Alternative Civic Facilities) serve the needs of the surrounding residents, employees, and visitors by providing a service or amenity not adequately available to the surrounding community or that contributes to the cultural or historic identity of the surrounding community; and do not result in an over-concentration of any one service or amenity.

c. **CEQA.** Approval of a CPIO Director’s Determination is a discretionary approval for purposes of CEQA Guidelines Section 15060(c)(1).

4. **CPIO Approval Compliance.** No demolition permit shall be issued for any Project unless building permits for a replacement development on the site have been issued, and any necessary land use entitlements have been granted.
- a. Notwithstanding the above this prohibition shall not apply to any structure deemed hazardous by the Department of Building and Safety.
 - b. Furthermore, this prohibition shall not apply to structures that are considered uninhabitable.

I –VII. Section I-7. ENVIRONMENTAL STANDARDS PROCEDURES

The Environmental Standards in Appendix A are included in the Downtown CPIO District to implement the Mitigation & Monitoring Program included as part of the Downtown Community Plan update and reviewed in the City of Los Angeles Downtown Community Plan Environmental Impact Report (Case No. ENV-2017-433-EIR), certified on XX, XX, XXXX.

Any Project subject to discretionary review within the CPIO Boundaries shall comply with all applicable Environmental Standards as set forth in Appendix A, subject to the following rules.

- A. Applicability of Environmental Standards.** A Project does not need to comply with any Environmental Standard that is not relevant to the scope of activities involved with the Project. For example, a Project that proposes only minor façade alterations and no grading shall not be subject to Environmental Standards that apply to grading activities (such as noise and vibration standards). The decision maker, in his or her reasonable discretion, shall determine those Environmental Standards that apply to a particular Project.
- B. Plans.** Compliance with all applicable Environmental Standards listed in Appendix A shall be demonstrated on the plans as project features (that is, features that are physically built into the Project such as an air filtration system) or as operational features

listed on a sheet within the plans (that is, features that are carried out either during the construction of the Project, or over the life of the project, such as the use of paints, sealants, and other building materials that yield low air pollutants).

- C. Modification of Environmental Standards.** Modifications of Environmental Standards do not require the processing of a CPIO Adjustment or CPIO Exception. The Director (or appeal body on appeal) may modify or not require an Environmental Standard listed in Appendix A for any Project when: (1) the Director finds in writing, based upon substantial evidence, the Environmental Standard is not necessary to mitigate an impact, including because of the existence of a similar or more effective regulation that applies to the Project; (2) the City complies with CEQA Guidelines, Section 15162, including by preparing an addendum or subsequent environmental clearance to the Downtown Community Plans EIR to analyze the impacts from the modifications to the Environmental Standards; or (3) the City prepares a new CEQA clearance for the Project. No CPIO Approval shall be issued for a Project with a modified Environmental Standard until this subsection has been complied with. The modification of an Environmental Standard is not independently appealable unless an appeal of an entitlement or CEQA determination is otherwise available through this CPIO District, the LAMC, or CEQA

I –VIII. Section I-8. DOWNTOWN STREET STANDARDS

Any Project within the CPIO Boundaries shall comply with all applicable standards as set forth in Appendix E. The provisions of the Downtown Street Standards, previously adopted under Ordinance 181,557, remain and are effectuated by this CPIO.

I –IX. Section I-9. USE OF BEST PRACTICE APPENDICES

The Best Practices in Appendices B, C, and D of this CPIO are not mandatory for Projects requiring an Administrative Clearance, Director’s Determination, CPIO Adjustment, or CPIO Exception pursuant to Section I-6.C of this CPIO, or any other Discretionary application filed within the CPIO Boundaries. The Best Practice Appendices provide resources that encourage livable and sustainable development in Downtown Los Angeles.

Nothing in this section, the Downtown CPIO District, or any other applicable citywide design guidelines, shall allow decision makers to approve, deny, or condition a discretionary approval based on these best practices.

I –X. Section I-10. CEQA CLEARANCE

For purposes of CEQA compliance for subsequent projects approved with a CPIO Approval, including, but not limited to, consideration of a CEQA clearance pursuant to Government Code Section 65457, Public Resources Code Section 21155.4; or CEQA Guidelines, Sections 15183 or 15183.3, the Downtown CPIO District shall operate and be treated as a specific plan, zoning ordinance, and a prior plan level decision for which an EIR was certified.

I –XI. Section 1-11 ADMINISTRATION

Nothing herein shall be construed to prohibit the Director from promulgating administrative guidelines to interpret and implement the Downtown CPIO District.

I–XII. Section I-12. SEVERABILITY

If any portion, subsection, sentence, clause or phrase of this ordinance is for any reason held by a court of competent jurisdiction to be invalid, such a decision shall not affect the validity of the remaining portions of this ordinance. The City Council hereby declares that it would have passed this ordinance and each portion or subsection, sentence, clause and phrase herein, irrespective of the fact that any one or more portions, subsections, sentences, clauses or phrases be declared invalid.

CHAPTER II – COMMUNITY BENEFITS STANDARDS SUBAREA A

COMMUNITY BENEFITS PROGRAM SUBAREA

A – DOWNTOWN COMMUNITY BENEFITS PROGRAM SUBAREA A

OVERVIEW

The Community Benefits Program (CBP) Subarea A strives to introduce more affordable housing development, provide access to public open space and community facilities, and facilitate the preservation and rehabilitation of historic resources in the Plan Area. This Subarea includes a tiered incentive structure that prioritizes Mixed-income and 100 Percent Affordable housing. Within the Subarea, there are three subsections that tailor the incentives to the surrounding context, offering greater intensities of FAR and height around fixed rail transit stations and bus corridors, and reinforcing the identity of neighborhoods.

Figure 2-1. - Downtown Community Benefits Program Subarea Map A.1¹

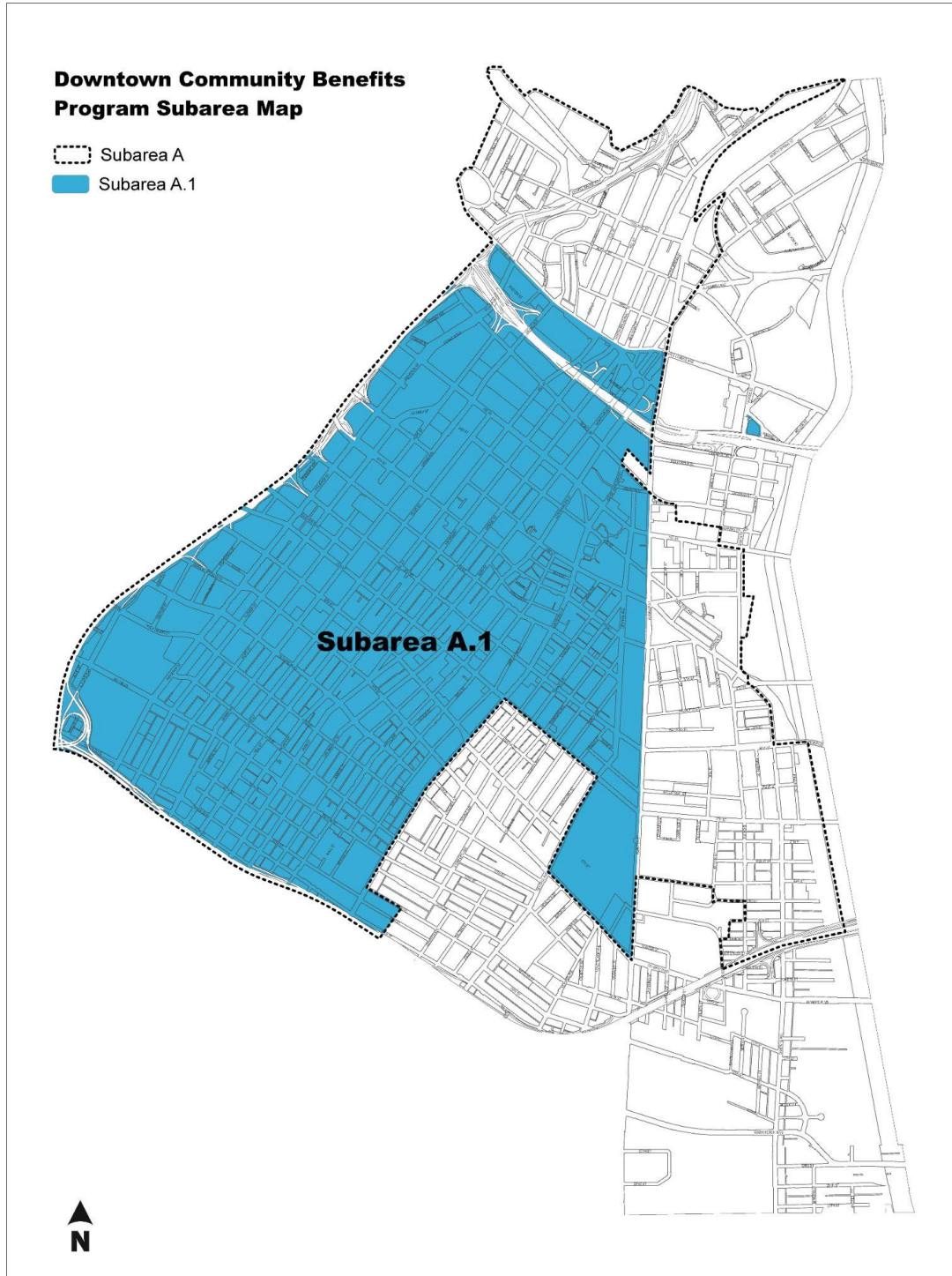

¹ For the purposes of LAMC Chapter 1A Section 1.4.4. this map shall be considered the Local Affordable Housing Incentive Map.

Figure 2-2. - Downtown Community Benefits Program Subarea Map A.2

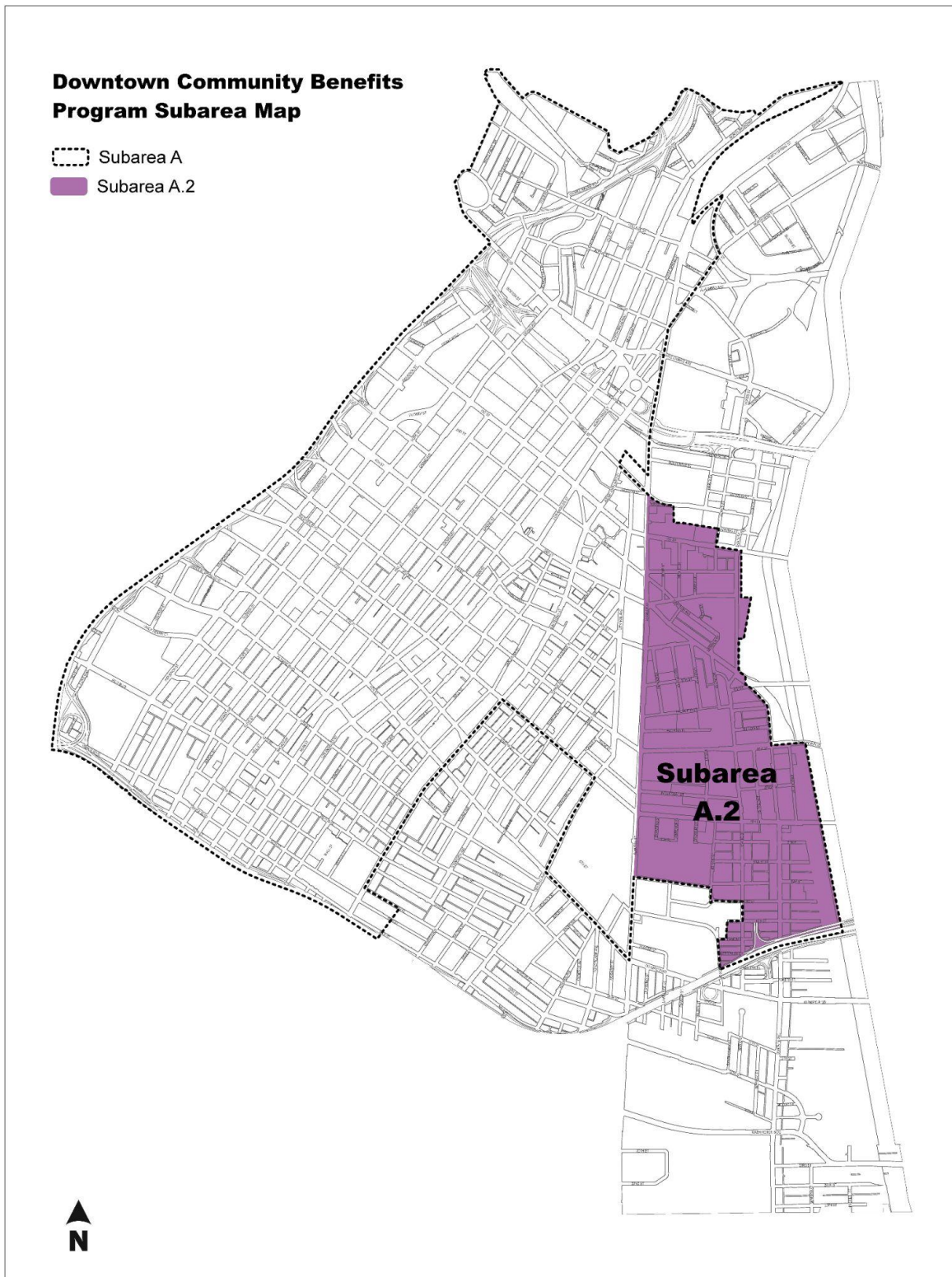

Figure 2-3. - Downtown Community Benefits Program Subarea Map A.3

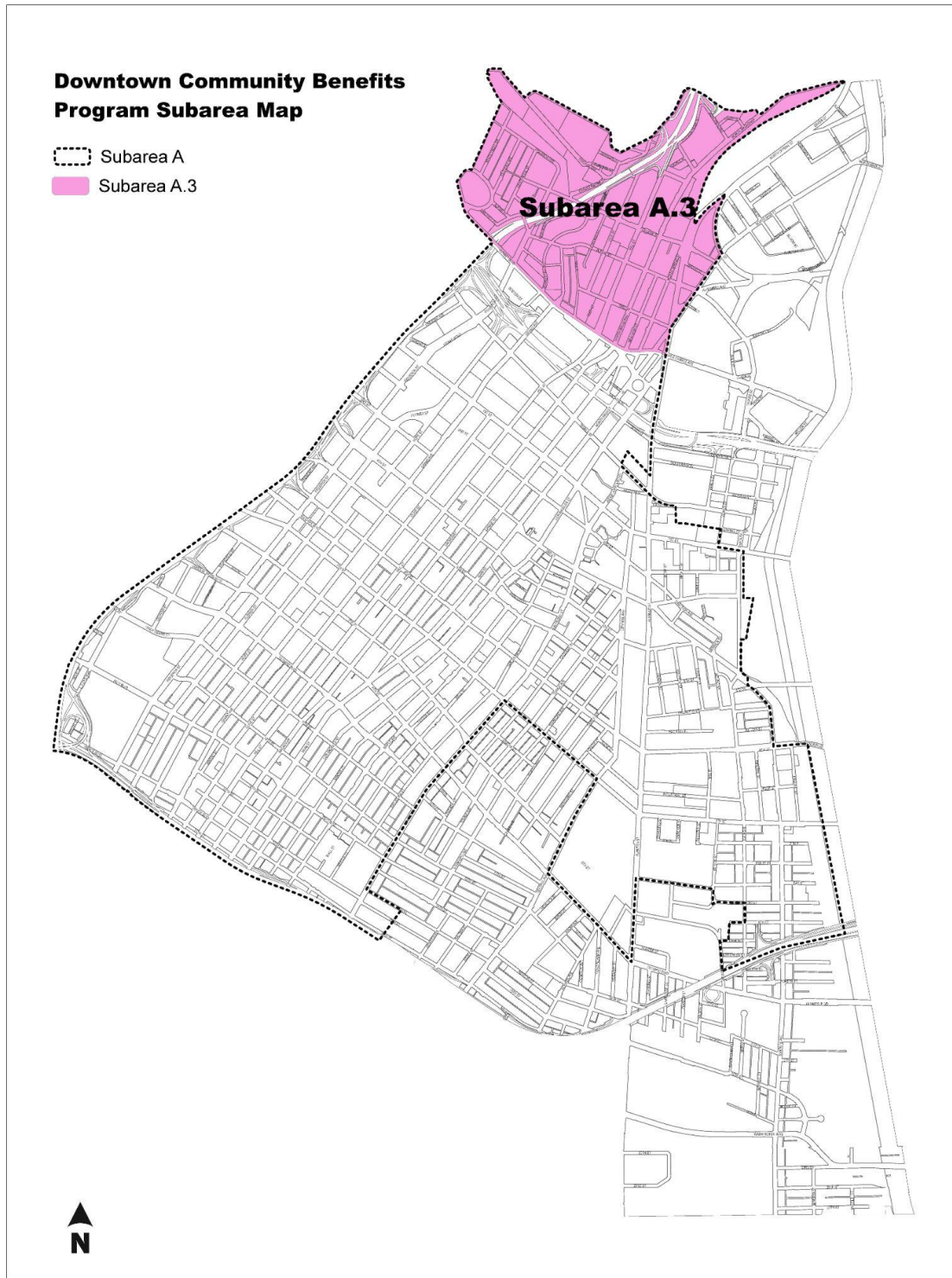
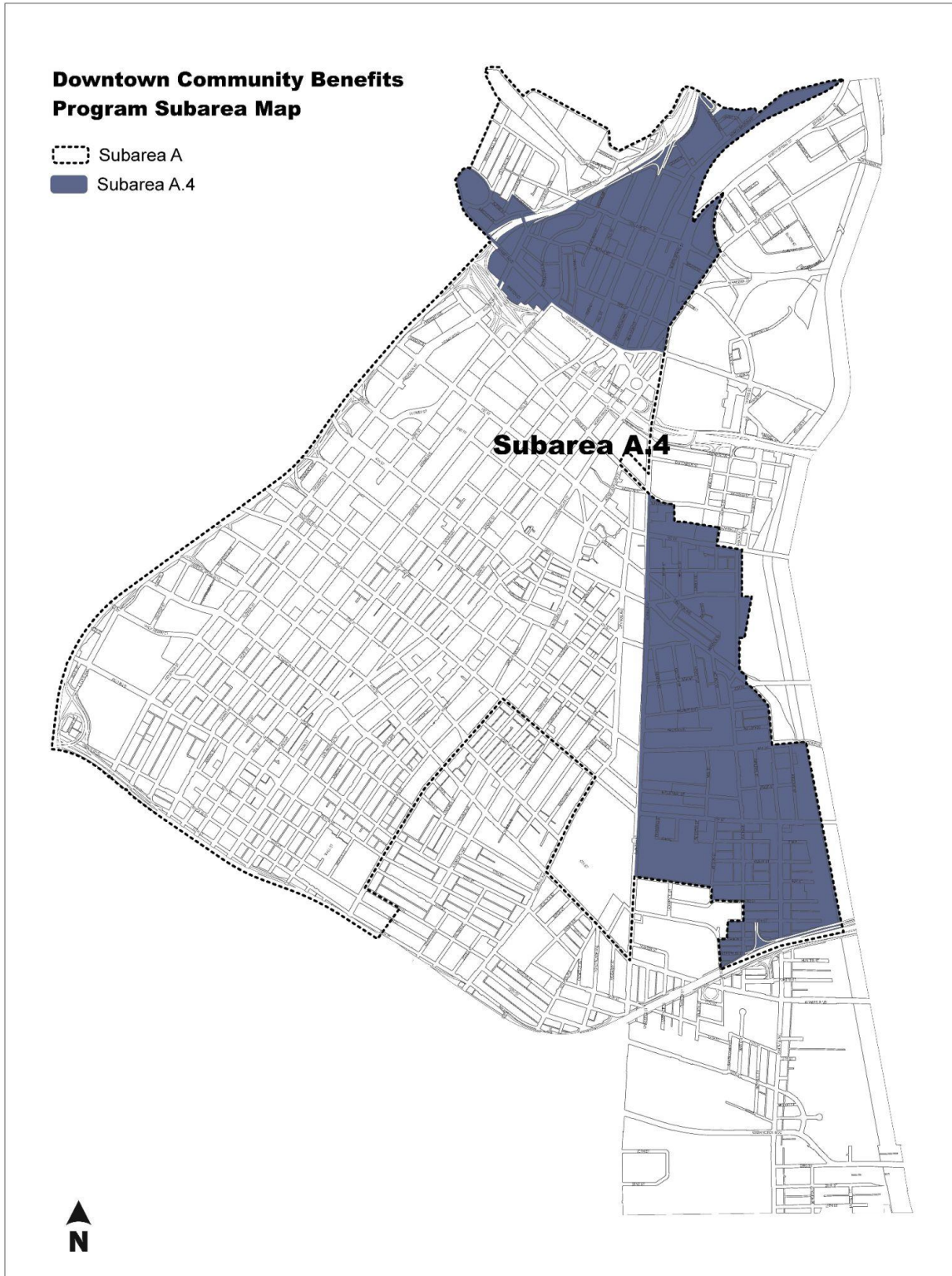

Figure 2-4. - Downtown Community Benefits Program Subarea Map A.4



II – I. 1. COMMUNITY BENEFITS STANDARDS

- A. Relief.** Requirements of this Chapter shall not be eligible for a Project Adjustment pursuant to LAMC Chapter 1A Section I3B.4.4 or a Project Exemption pursuant to LAMC Chapter 1A Section I3B.4.5.
- B. Pro Rata Share.** Projects may seek less than the full increment of FAR available through the incentives in this Chapter provided that they provide a proportional share of community benefits and meet the minimum requirements below.
- C. Administrative Guidelines.** The Director may prepare administrative guidelines for the implementation of the Community Benefits Program.

II – II. 2. LOCAL AFFORDABLE HOUSING INCENTIVE PROGRAM PURSUANT TO LAMC CHAPTER 1A 9.3.2

- A.** A Housing Development that meets the requirements below may obtain an additional 40% FAR above the subject site's base Maximum FAR.

B. Requirements

- 1. On-Site Restricted Affordable Units.** Within the boundaries of this CPIO Subarea, a Housing Development shall provide Restricted Affordable Units at rates outlined in Set G of LAMC Chapter 1A Section 9.3.2.B. The minimum number of Restricted Affordable Units shall be calculated based upon the total number of units in the final project.
- 2. Off-site Construction.** The affordability provisions of this Section may be satisfied by constructing off-site affordable units at the following rate:

No less than the same number of on-site affordable units, at the same or greater mix of unit type and affordability levels as provided in Section 11-2A, off-site units must be provided within the boundaries of the Downtown Community Plan Area. The off-site units created pursuant to this paragraph must be on a site that is zoned for residential development at a density to accommodate at least the number of otherwise required units; is suitable for development of the units in terms of configuration, physical characteristics, location, access, adjacent uses and other relevant planning and development criteria; and environmental review has been completed to the satisfaction of the City prior to acceptance of the site by the City. The development of off-site affordable units shall include integration of community space and services as required by the Housing and Community Investment Department for comparable affordable housing development. The first Certificate of Occupancy for the off-site units shall be issued prior to or concurrent with the first building permit for the original Project. In no event shall the Certificate of

Occupancy for the market rate units for the original project be issued prior to the Certificate of Occupancy for the affordable off-site units. Individual affordable units constructed as part of an off-site project under this Section shall not receive development subsidies from any Federal, State or local program established for the purpose of providing affordable housing, and shall not be counted to satisfy any affordable housing requirement for the off-site development. Other units in the same offsite project may receive such subsidies. In addition, subsidies may be used, only with the express written permission by the Department of Housing and Community Investment, to deepen the affordability of an affordable unit beyond the level of affordability required by this Section.

3. In-Lieu Fee. The affordability provisions of this Section may be satisfied by the payment of a fee to the City of Los Angeles Downtown Affordable Housing Trust Fund in lieu of constructing the affordable units within the Project. The in lieu fee shall be determined by the City based on the following:

The number of units equivalent to 1.1 times the required number of on-site affordable units pursuant to Section II-2B.1, in the same proportion of affordability, multiplied by the applicable Affordability Gap, as defined in LAMC Chapter 1A Section 13.3.1.E.4.

The fee is due and payable to the City of Los Angeles Downtown Affordable Housing Trust Fund at the time of and in no event later than issuance of the first building permit, concurrent with and proportional to project phases.

4. Dwelling Unit Mix and Location. For sites located in Subarea A.3, a minimum of 30% of the total dwelling units for an eligible Housing Development shall be two bedrooms or greater.

C. Additional Incentives. In addition to the FAR and height bonus identified in LAMC Chapter 1A Section 9.3.2.C, a Housing Development Project shall be granted two additional incentives and a Housing Development Project consisting of 100% on-site restricted affordable units, exclusive of a manager's unit or units, shall be granted three additional incentives. Projects shall not be granted an adjustment, pursuant to LAMC Chapter 1A Section 13.B.5.2, in addition to a selected incentive. This shall supersede LAMC Chapter 1A Section 9.3.2.D

Building Width. See LAMC Chapter 1A Section 2.C.6

- a. For all eligible Housing Development Projects, up to a 20% increase in maximum building width may be granted.

Lot Coverage. See LAMC Chapter 1A Section 2.C.2

- b. For all eligible Housing Development Projects, up to a 20% increase in maximum lot coverage may be granted.

Lot Width. See LAMC Chapter 1A Section 2.C.1

- c. For all eligible Housing Development Projects, up to a 20% decrease in required minimum lot width may be granted.

Averaging of Floor Area. See LAMC Chapter 1A Section 2.C.4.

- d. A Housing Development Project that is located on two or more adjacent parcels may average the Floor Area over the project site provided that:
 - i. The proposed use is permitted by the Use District of each parcel; and
 - ii. No further lot line adjustment or any other action that may cause the Housing Development Project site to be subdivided subsequent to this grant is permitted.

Ground Story Height. See LAMC Chapter 1A Section 3.C.6.1

- e. For all eligible Housing Development Projects zoned with a character frontage, up to a 10% decrease in the required minimum Ground Story Height may be granted.

Minimum Average Unit Size. See LAMC Chapter 1A Section 5.C.3.26

- f. For all eligible Housing Development Projects, up to a 25% decrease in the required minimum average unit size may be granted.

II – III. 3. PUBLIC BENEFITS INCENTIVE PROGRAMS PURSUANT TO LAMC CHAPTER 1A Section 9.3 to promote the production of improvements, facilities, resources, and services beyond affordable housing for the benefit and enjoyment of the general public.

A. Transfer of Development Rights for Historic Preservation pursuant to LAMC Chapter 1A Section 9.3.5

1. **For sites located in Subarea A.4,** a Receiver Site may receive all available unused Floor Area from the Donor Site, including the Donor Site’s Bonus FAR, at a 1:1 ratio (i.e., for every square-foot transferred from a Donor Site a Receiver Site gets one square-foot) up to the Receiver Site’s allotted Bonus FAR.
2. **Applicability.** The procedures contained in this subsection apply exclusively to properties within Subarea A.4 subject to the eligibility requirements and other regulations below.
3. **Eligibility.** A transfer of unused Floor Area, including Bonus FAR, from a Donor Site to a Receiver Site is permitted, provided the transfer is in conformance with the following rules for transfer:
 - a. The Donor Site is designated as a Los Angeles Historic-Cultural Monument, a Contributing Structure to a City Historic Preservation Overlay Zone, is listed in or formally determined eligible for the California Register of Historical Resources or the National Register of Historic Places, or is identified as a contributor to a historic district or individual resource by SurveyLA, or another historical resource survey completed, by a person meeting the Secretary of the Interior’s Professional Qualification Standards for Historic Preservation and accepted as complete by the Director, in consultation with the Office of Historic Resources (OHR).
 - b. The Donor Site has unused Floor Area under its Base FAR and/or Bonus FAR pursuant to Article 2 (Form).
 - c. The Receiver Site shall not demolish any structure qualifying as a donor site, as defined in Section II-III.A.3.b above.

- 4. Records and Agreements.** To utilize a Transfer of Development Rights, an application must be filed pursuant to LAMC Section 13.4.5 (Director Determination). In addition, the following requirements shall apply:
- a. The applicant shall consult with the Department of City Planning, Office of Historic resources to identify, with respect to the Donor Site, the significant historic features that are required to be maintained, and to identify any rehabilitation work required to be completed.
 - b. A Preservation Plan and easement, pursuant to Subdivision II-III.3.A.4.d below, shall be completed prior to the completion of the Director Determination process.
 - c. Following the issuance of a Director Determination, and prior to the issuance of building permits for a project utilizing a Transfer of Development Rights, all fee owners of the Donor Site(s) and receiver Site(s) involved shall execute a covenant and agreement in a form designed to run with the land and be binding on future owners, assigns and heirs and which is satisfactory to the Department of City Planning. The applicant shall record the covenant in the County Clerk Recorder's Office and shall file certified copies with the Departments of City Planning and Building and Safety.
 - i. Donor Site Covenant: The covenant on a Donor Site shall acknowledge the reduced Floor Area to the extent unused permitted Floor Area was transferred to a receiver Site(s), and the location of the receiver Site(s).
 - ii. Receiver Site Covenant: The covenant on a Receiver Site shall acknowledge the increased Floor Area to the extent unused permitted Floor Area was transferred from a Donor Site(s), and the location of the Donor Site(s).
 - iii. Covenant Applicability: The covenants shall apply as long as the transferred Floor Area is being utilized by the Receiver Site. If the Receiver Site is no longer utilizing the transferred Floor Area, the owner of the Receiver Site may apply to terminate the covenant.
 - d. Preservation Plan and Easement: The Donor Site shall execute a Preservation Plan and easement, with the following minimum standards:
 - i. The Preservation Plan and easement shall be executed with the Department of City Planning, Office of Historic resources or a qualified non-profit Historic Preservation Organization, or other entity of the city's choosing, and;
 - ii. The Preservation Plan and easement shall address, at a minimum:
 - 1) Maintenance of the resource, the property, and significant historic features;
 - 2) Additions and alterations to the resource and/or significant elements of any building and the property;
 - 3) Required rehabilitation work to any significant historic features;
 - 4) Required rehabilitation work must be completed within 10 years of the recordation of the Preservation easement;
 - 5) Inspections to ensure compliance with the Preservation easement. Inspections must occur at minimum once every 5 years, however the number of inspections may be increased as part of the Preservation Plan and easement;

- 6) Other standards and requirements as required by the Director of Planning;
- 7) Fines and penalties for violating any section of the Preservation Plan and easement. The Preservation Plan and easement shall apply as long as the transferred Floor Area is utilized on the Receiver Site. If the owners of the donor site that is the subject of the Preservation Plan and easement have violated the Plan and easement, the owners of the resource shall pay a fine equal to ten (10) times the value of the application fee and cumulative inspection fees paid.

B. Privately Owned Public Space pursuant to LAMC Chapter 1A 9.3.3.

1. For every additional four percent of buildable lot area dedicated as publicly accessible outdoor amenity space, above the subject site's required Lot Amenity Space, eligible projects may obtain an additional 1.0:1 FAR for either of the following:
 - a. Land dedicated for public open space, in consultation with the Department of Recreation and Parks.
 - b. On-site publicly accessible open space, constructed in accordance with the requirements listed below:
 - i. At least one public restroom and drinking water fountain shall be provided within, adjacent to, and/or and directly accessible from the publicly accessible open space. Public restrooms shall be made available during the operational hours of the publicly accessible open space, and shall not necessitate the need to enter secured or otherwise publicly inaccessible portions of a building or site. Signage viewable from within the publicly accessible open space shall indicate that the restroom and drinking water fountain is available for public use.
 - ii. At least one of the amenity options listed below, which shall occupy a minimum of 400 square feet with no horizontal dimension less than 15 feet, shall be provided within or adjacent to the publicly accessible open space:
 - a. Outdoor exercise equipment available for public use
 - b. Sport courts available for public use
 - c. Dog run available for public use
 - d. Children's play area available for public use
 - e. Community garden available for public use
 - f. Public art or historical interpretive element
 - g. Alternative Open Space Amenities deemed appropriate by the Director of Planning and approved under a Director's Determination
 - iii. At least 20% of the publicly accessible open space shall be shaded. Percentage shading shall be the shadow cast on the publicly accessible open space measured at noon (12:00 p.m.) on the summer solstice.

- iv. A minimum of three public charging stations for personal electronic devices, with features like power outlets and USB connections, shall be provided at no cost to users.

C. Community Facilities pursuant to LAMC Chapter 1A 9.3.4

1. Sites seeking to utilize the Community Facilities incentive must dedicate a minimum of 5,000 square feet to one of the eligible uses below. In addition to the minimum required space, for every 2.5% of bonus buildable floor area dedicated to one of the following, eligible projects may obtain an additional 1.0:1 FAR:
 - a. School and Library pursuant to LAMC Chapter 1A Section 9.3.4.C.5
 - b. Social Services pursuant to LAMC Chapter 1A Section 9.3.4.C.6
 - i. Alternative Social Services shall require the approval of a Director's Determination.
 - c. Civic Facility pursuant to LAMC Chapter 1A Section 9.3.4.C.7
 - i. Alternative Civic Facilities shall require the approval of a Director's Determination.
 - d. Daycare Facility pursuant to LAMC Chapter 1A Section 9.3.4.C.1
2. For sites located in Subarea A.2, projects in which a minimum of 50% of the total Floor Area, inclusive of any bonus floor area, contains non-residential uses, excluding uses in the Eating and Drinking Establishments, Personal Services, and Retail Sales use groups, may obtain additional floor area above the base FAR and up to 4.0:1 FAR pursuant to the Employment Incentive Area, LAMC Chapter 1A Section 9.3.4.C.4.
 - e. A Housing Development must fully utilize the Local Affordable Housing Incentive Program pursuant to LAMC Chapter 1A 9.3.2 before obtaining Floor Area through this incentive.

II – IV. 4. Additional On-Site Restricted Affordable Units.

- A. A Housing Development may exceed the bonus FAR received through the Local Affordable Housing Incentive Program up to the maximum bonus FAR by an additional 1.0:1 FAR for each increase in the amount of on-site restricted affordable units, calculated on the total number of units, according to the following percentages: 1.5% Deeply Low, Extremely Low Income, or Very Low Income; or 2.5% Low Income, or Moderate Income (for sale or rent).
 1. A Housing development may only obtain an additional 2.0:1 FAR by providing restricted affordable units for Moderate Income. Any additional bonus FAR must be obtained through the provision of restricted affordable units for Deeply Low, Extremely Low, Very Low, or Low Income or through the provision of other Public Benefits as specified in this CPIO.

- ### **II – V. 5. Height Incentives for non-residential projects.**
- A non-residential project receiving at least 1.0:1 FAR through any of the Public Benefits Incentive Programs above shall be eligible for the maximum bonus height in the Form District.

- ### **II – VI. 6. Community Benefits Fund pursuant to LAMC Chapter 1A 9.3.4.C.9.**
- Projects that have satisfied minimum onsite or commensurate benefits under Sections II-III through II-V, as

specified under II-VIII A and B below, may achieve additional floor area by submitting payment to a Community Benefits Fund as specified in Ordinance XXX,XXX.

- A. For Housing Development Projects, a project must meet the requirements of the Local Affordable Housing Incentive Program and provide Public Benefits as follows:
 - 1. Up to an FAR equivalent to one-half of the delta between 1.4 times the Base Maximum FAR, and the Bonus Maximum FAR.
- B. For non-residential projects, a project must provide Public Benefits up to an FAR equivalent to one-half of the delta between the Base Maximum FAR, and the Bonus Maximum FAR.
- C. Community Benefit Fund payments shall be collected from Project applicants and deposited into a Downtown Community Benefit Trust Fund prior to the issuance of an Administrative Clearance or other approval consistent with this CPIO. Fund payment collection and disbursement shall be consistent with the terms of the ordinance to establish the Downtown Community Benefit Trust Fund.

II – VII. 7. Buildable Area Calculation. For a project on a lot designated, in whole or in part, as Transit Core by the General Plan Land Use Map, the Maximum Bonus Floor Area Ratio shall be calculated by including the lot area plus the area between the exterior lot lines and the centerline of any abutting public right-of-way. For a development project to be eligible:

- A. A Housing Development must fully utilize the Local Affordable Housing Incentive Program pursuant to LAMC Chapter 1A 9.3.2 and the Public Benefits Incentives Programs above and up to the subject site's Maximum Bonus Floor Area Ratio.
- B. A non-residential project must fully utilize the Public Benefits Incentive Programs above up to the subject site's Maximum Bonus Floor Area Ratio.
- C. For the purposes of calculating required restricted affordable units and public benefits, floor area and lot area shall be calculated using the total buildable area, as defined above, including the area between the exterior lot lines and the enterline of any abutting public right-of-way.

II – VIII. 8. Project Review Threshold. For a Housing Development project fully utilizing the Local Affordable Housing Incentive Program pursuant to LAMC Chapter 1A 9.3.2 or a non-residential project receiving at least 1.0:1 FAR through any of the Public Benefits Incentive Programs above, the threshold for project review pursuant shall be Development Review Threshold Package 2 pursuant to LAMC Chapter 1A Section 4C.14.1.C.2.

CHAPTER III – BUNKER HILL DEVELOPMENT STANDARDS SUBAREA

BUNKER HILL DEVELOPMENT STANDARDS SUBAREA

B – BUNKER HILL DEVELOPMENT STANDARDS SUBAREA B

OVERVIEW

The purpose of this Subarea is to maintain an integrated network of pedestrian linkages throughout the Bunker Hill area, as initially established under Ordinance 182576. Figure 3 shows the general location of the pedestrian linkages. The network of linkages, and the provisions hereinafter set forth to implement such a network, shall be applicable to all projects and to all properties within the Subarea, as more particularly designated in Figure 1.

- III – I. Maintenance of Existing Easements for Pedestrian Walkways.** Existing public easements for Pedestrian Walkways, as shown in Figure 3, must be maintained unless an equivalent pedestrian easement is provided, pursuant to a Director's Determination. Existing public easements shall be maintained in accordance with the following:
- A.** The Pedestrian Walkway shall be open to the public between the hours of 5 a.m. and 10:30 p.m., but may be closed outside of such hours.
 - B.** The use of any components of the Pedestrian Walkway by the public shall not be revoked by the owner of any building or site without the prior written approval of the Director and the City Engineer. This Section does not supersede the City's right-of-way vacation process. Such approval shall be given only if (1) the buildings or other improvements to be served by such components have been demolished, or (2) a particular component presents a danger to public safety.
 - 1.** Any changes in the approximate location of the Pedestrian Walkway shall be subject to the Director's approval upon a finding that any such change will provide equal or better pedestrian access and safety.

Figure 3. – Bunker Hill Pedestrian Linkages²

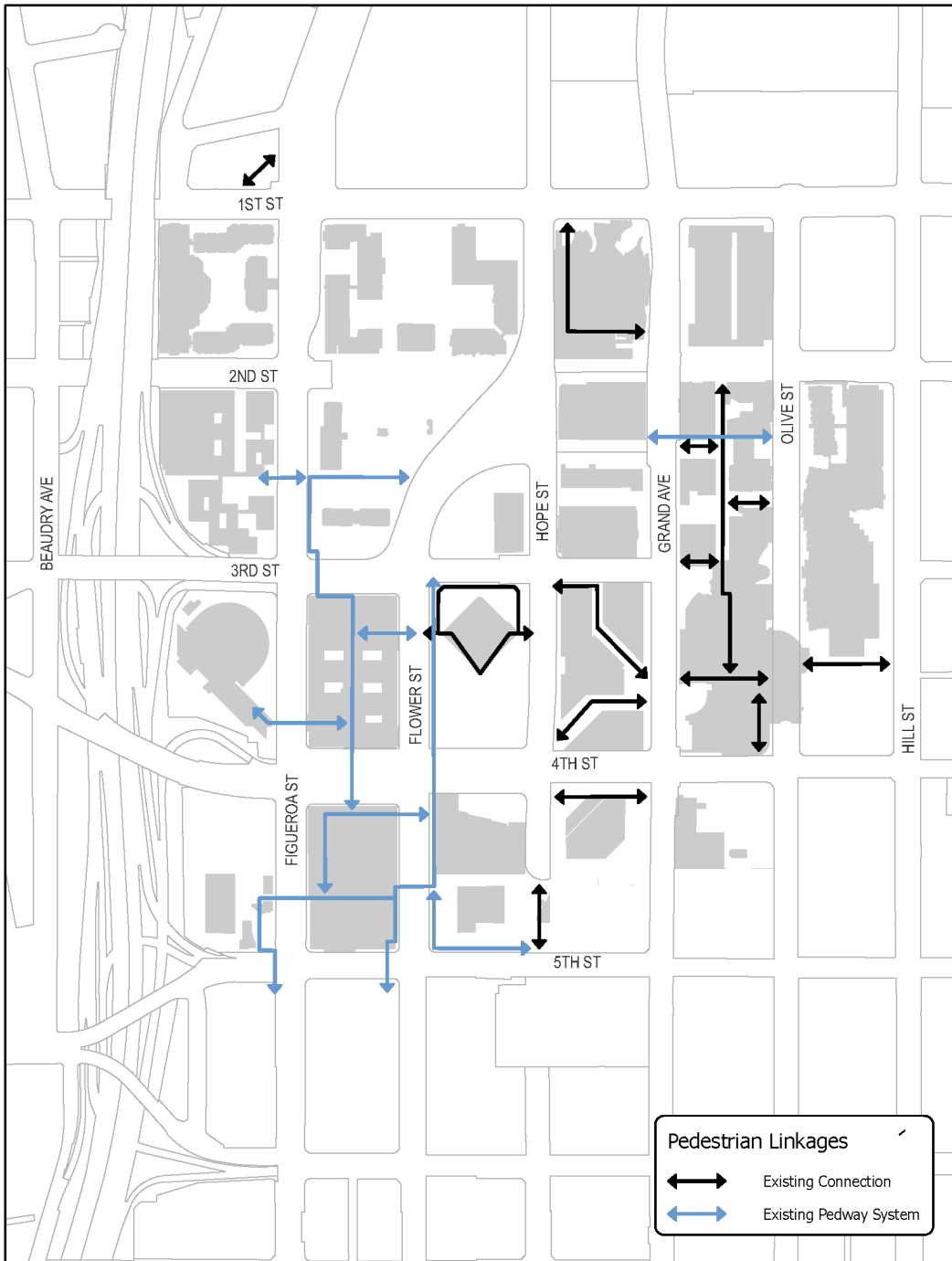

² This map is for illustrative purposes, for exact locations of pedestrian linkages see recorded easements on the subject sites.

CHAPTER IV – CIVIC CENTER SUBAREA

CIVIC CENTER DEVELOPMENT STANDARDS SUBAREA

C – CIVIC CENTER DEVELOPMENT STANDARDS SUBAREA C

OVERVIEW

The purpose of Subarea C is to introduce affordable housing, ensure active frontages for commercial uses, and regulate the amount of development across the district and allow for floor area to be transferred between City-owned properties in the Civic Center Master Plan Area to support an active and world-class Civic Center environment.

- V – I. On-Site Restricted Affordable Units.** Within the boundaries of this CPIO Subarea, a minimum of fifty percent of all permitted and constructed residential units shall be on-site Restricted Affordable Units in the Deeply Low, Extremely Low, Very Low, Low, or Moderate.
 - A.** Of these Restricted Affordable Units, a minimum of fifty percent shall be restricted to lower income households, in the Deeply Low, Extremely Low, Very Low, or Low income categories.
 - B.** The minimum percentage of Restricted Affordable Units shall be maintained across all residential development of this CPIO Subarea and shall be calculated based on the total number of dwelling units permitted within this Subarea.
 - C.** Any individual Housing Development shall provide on-site Restricted Affordable Units greater than or equal to the rates outlined in Set G of LAMC Chapter 1A Section 9.3.2.B. The minimum number of Restricted Affordable Units shall be calculated based on the total final project dwelling unit count. Projects developed in accordance with this section shall be eligible for the Project Review thresholds established under II-VIII.8
- V – II. Frontage Standards.** Within the boundaries of this CPIO Subarea, any development including uses specified as General Commercial Uses, pursuant to LAMC Chapter 1A Section 5C.1.5, located on the ground floor shall adhere to the Transparency and Entrances standards of the General 1 Frontage, pursuant to LAMC Chapter 1A Section 3B.3.1.
- V – III. Transfer of Floor Area.** Any owner(s) of a legally defined lot located within Subarea C may transfer unused permitted floor area to another legally defined lot within Subarea C, pursuant to the procedures of this section.
 - A. Floor Area.** Total floor area in the Civic Center Subarea shall not exceed a ratio of 6.5:1. Individual sites within the Subarea may exceed a floor area ratio of 6.5:1 through a transfer of floor area.
 - B. Limitation.** Any project constructed with transferred floor area must comply with all regulations set forth in this Subarea.
 - C. Procedures.** Projects seeking the transfer of unused permitted floor area, within the floor area cap, shall apply for an Administrative Clearance pursuant to the provisions of Section I-6 C.2 of this CPIO.

CHAPTER V – HISTORIC PRESERVATION SUBAREA

HISTORIC PRESERVATION SUBAREA

D – HISTORIC PRESERVATION SUBAREA D

OVERVIEW

The purpose of this subarea, which includes neighborhoods that have an abundance of historically and architecturally significant buildings, is to maintain the eligibility of individual historic resources and historic districts, and guide the ongoing maintenance and rehabilitation of these structures.

V – I. Eligible Historic Resource Evaluation. Prior to any other CPIO Approval being issued, a Project in this subarea that involves an Eligible Historic Resource shall comply with the following review procedures:

A. Non-Demolitions. For any Project that does not involve the demolition of an Eligible Historic Resource, no CPIO Approval shall be issued until one of the following occurs:

1. The Director, in consultation with the Office of Historic Resources, determines, based upon substantial evidence, that the Eligible Historic Resource is not an historical resource, as defined by Public Resources Code Section 21084.1; or,
2. The Director, in consultation with the Office of Historic Resources, determines, based upon substantial evidence, that the Project is consistent with the Secretary of Interior's Standards for the Treatment of Historic Properties with Guidelines for Preserving, Rehabilitating, Restoring, and Reconstructing Historic Buildings; or,
3. A Director's Determination pursuant to Section I.VI.C.3 of this CPIO, and Environmental review in compliance with CEQA was completed for the Project, including if necessary, the adoption of a statement of overriding considerations.

B. Demolitions. For any Project that involves the demolition of an Eligible Historic Resource, no CPIO Approval shall be issued until one of the following occurs:

1. The Director, in consultation with the Office of Historic Resources, determines, based upon substantial evidence, that the Eligible Historic Resource is not an historical resource, as defined by Public Resources Code Section 21084.1; or

2. A Director's Determination pursuant to Section I.VI.C.3 of this CPIO, and, Environmental review in compliance with CEQA was completed on the Project, including if necessary, the adoption of a statement of overriding considerations.
 - a) No Director's Determination shall be issued for Demolition or removal of any building or structure, within a National Register Historic District, within Subarea D, that is designated as a Contributing Element, and the application shall be denied unless the Owner can demonstrate to the Director that the owner would be deprived of all economically viable use of the property. In making its determination, the Director shall consider any evidence presented concerning the following:
 - (1) An opinion regarding the structural soundness of the structure and its suitability for continued use, renovation, Restoration or Rehabilitation from a licensed engineer or architect who meets the Secretary of the Interior's Professional Qualification Standards as established by the Code of Federal Regulation, 36 CFR Part 61. This opinion shall be based on the Secretary of the Interior's Standards for Architectural and Engineering Documentation with Guidelines;
 - (2) An estimate of the cost of the proposed, demolition, and replacement project and an estimate of the cost that would be incurred to execute a Secretary of the Interior's Standards for Rehabilitation alternative to the project, as identified in a Project Environmental Impact Report (EIR), or in the absence of an EIR, when appropriate under CEQA, as identified by the Director of Planning in consultation with the Cultural Heritage Commission or its designee.;
 - (3) An estimate of the market value of the property in its current condition; after completion of the proposed Demolition and replacement project; and after any expenditure necessary to execute a Secretary of the Interior's Standards for Rehabilitation alternative to the project, as identified in a Project Environmental Impact Report (EIR), or in the absence of an EIR, when appropriate under CEQA, as identified by the Director of Planning in consultation with the Cultural Heritage Commission or its designee;
 - (4) An estimate from architects, developers, real estate consultants, appraisers, or other real estate professionals experienced in Rehabilitation as to the economic feasibility of Restoration, renovation or Rehabilitation of any existing

structure or objects. This shall include tax incentives and any special funding sources, or government incentives which may be available.

- C. CEQA Review for Eligible Historic Resources.** In complying with this Section V-I., if at any time the Director, in consultation with the Office of Historic Resources, determines the Eligible Historic Resource is not a historical resource as defined by Public Resources Code Section 21084.1, approval of the Project (involving no other discretionary approvals) shall be a ministerial approval for purposes of CEQA, including CEQA Guidelines, Section 15268.

APPENDIX A – ENVIRONMENTAL STANDARDS

OVERVIEW

As described in Section I-7 of the CPIO District, these Environmental Standards are included to implement the Mitigation & Monitoring Program included as part of the Downtown Community Plan update and reviewed in the Downtown Environmental Impact Report (Case No. ENV-2017-433-EIR), certified by the City Council.

In addition to Projects in Subareas that are required to comply with these Environmental Standards, any other discretionary project in the boundaries of the Downtown Community Plan Area that seeks to rely on the Downtown EIR for its CEQA clearance (including through tiering, preparing an addendum, supplemental EIR or a statutory infill exemption), may incorporate or impose the following Environmental Standards on the project. Compliance may be achieved through covenant, conditions, plan notations, or other means determined reasonably effective by the Director of Planning or the decision-maker.

[MITIGATION MEASURES / ADDITIONAL ENVIRONMENTAL STANDARDS FORTHCOMING]

Downtown Community Plan Implementation Overlay Appendix B

Tall Buildings Best Practices



Source: Shutterstock

TALL BUILDING BEST PRACTICES

INTRODUCTION

Tower placement shall be strategically coordinated with neighboring properties in order to find a balance between maximizing views to the sky for pedestrians, minimizing conflicts with existing or potential future towers, and contributing to an attractive skyline. For the purposes of this document, a “tower” is defined as any building over 150 feet in height. Any portion of a building that is above 150 feet in height is subject to the tower standards and guidelines in this section. Final tower placement and spacing shall be subject to the regulations of all applicable codes, including the LAMC, in consultation with staff from the Department of City Planning, Department of Building and Safety and Fire Department. Renderings and elevations of the proposed project in relation to the massing and elevations of surrounding buildings are preferred.

ORIENTATION, SPACING & RELATIONSHIP TO SURROUNDING CONTEXT

Intent: To promote design and placement of towers that respond to the surrounding context through thoughtful scaling, floor plate sizing, spacing, and orientation. New towers that provide a seamless transition between surrounding buildings while providing definition for surrounding streets, parks, and open space areas, are highly encouraged.

The following section provides best practices on all aspects of the building, and should be considered in their entirety.

■ ■ ■ SITE PLANNING

When there is an adjacent Designated or an Eligible Historic Resource that is protected from development per historic preservation regulations, the tower may be spaced per recommendations of the Office of Historic Resources. Where appropriate, incorporate design features so as to not undermine historic resources.

For sites where the adjacent context is lower scale and not anticipated to change, provide a transition in the base building height down to the lower-scale neighbors or incorporate design features that meet the roof line of adjacent structures.

When multiple towers are located within a block or site, vary heights and coordinate placement to create visual interest within the skyline, mitigate wind, and improve access to sunlight and sky view within the public realm. If a project has more than one tower, employ a cohesive design approach and design towers that complement each other.



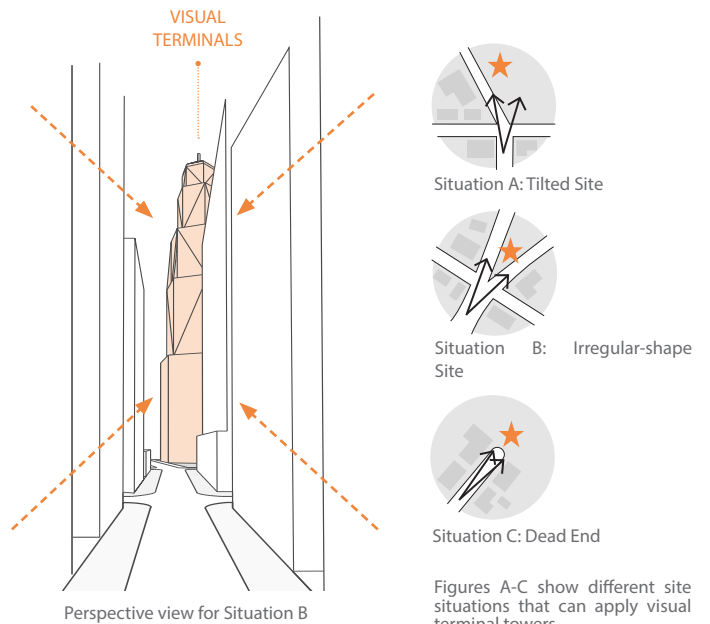
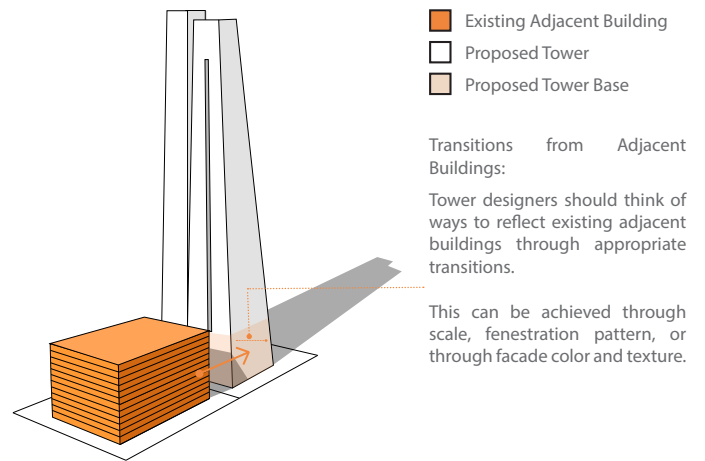

Situate towers and shape its massing so as to frame and highlight noteworthy natural and built environment features.

Locate and design towers to appropriately frame or terminate visual axes.

When towers are located adjacent to an open space such as a park, consider placement of towers and other techniques to frame and define the open space. Tower placement can enhance the quality of the open space by creating a mix of shade and sunlight areas.



These graphics demonstrate ways in which tall buildings can be located on a site in order to define a visual terminus, form landmarks, and define a sense of space.

-  Visual Access
-  Proposed Tower (Visual Terminal)
-  Proposed Tower (Visual Terminal)
-  Existing Contextual Building

■ ■ ■ BUILDING DESIGN AND ARTICULATION

Design the base building to fit harmoniously within the existing context of neighboring building heights.

Towers that extend directly upwards from the property line at the street are often appropriate, and are not required to be set back. Curtain walls for towers may also extend vertically from the tower crown to the ground floor to accentuate the tower presence along the street front. Consider innovative techniques to mitigate wind flow such as variation of street wall articulation and material choice, building orientation, softened corners, or modifying the core through twisting and tapering.

Towers designed to taper upwards, in order to reduce overall bulk and appear slender are generally desirable. Towers in Downtown greatly affect the appearance of the overall city skyline. Evaluations in other cities suggest that towers are most attractive when they have a ratio of height to width of about 3.5:1 (for example, 350 feet tall and 100 feet wide). Consideration of this ratio is a good starting point. Reducing the bulk of a tower's top half, through a process of "sculpting", it can be made more appealing. Consider designing towers that have slender massing and sound proportions.

COMMON TOWER FORMS

These diagrams illustrate different relationships between the tower, the tower-base and any adjacent street wall.

A. TOWERS AT STREET CORNERS

B. TOWERS ALONG STREET SIDES

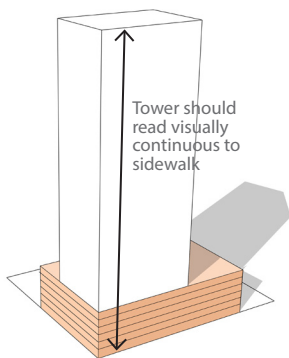

- Proposed Tower
- Proposed Tower Base

1. Tower with Projected Base:

Base (or podium) with the tower set flush to a street corner. The tower massing and detail reads visually continuous to the sidewalk. A curtain wall that extends to the ground floor can be used to reinforce continuity.

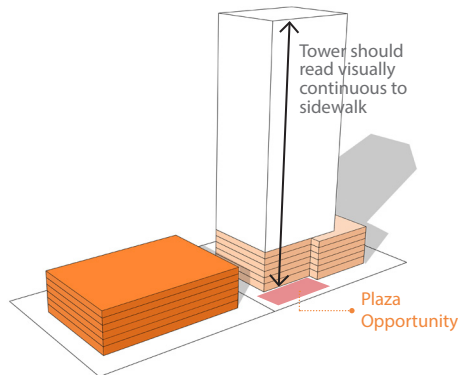

- Existing Adjacent Building
- Proposed Tower
- Proposed Tower Base

3. Tower Engaged with Base:

Base and tower forms are engaged. The tower massing and detail reads visually continuous to the sidewalk.

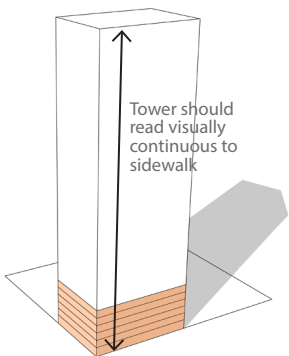

2. Tower without Projected Base:

Tower form without a base.

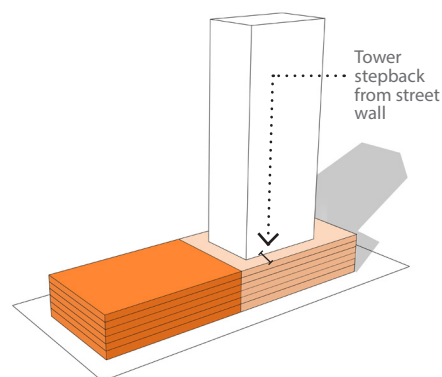

4. Tower Set onto a Base:

Usually the tower rises above the base and steps back from the street wall 20 feet or more. This form is not generally allowed, except for projects within the Historic Core or within a property within a block contiguous to a freeway or freeway ramp.

ARCHITECTURAL DETAILS, MATERIALS AND LIGHTING

Choice of materials, architectural detailing and lighting of exterior facades, when thoughtfully incorporated can strengthen the vertical connection between the base and tower portion of a development. Employ building features that contribute to an active street life and provide visual interest from ground level and elevated vantage points.

Where appropriate, inset balconies to avoid arrangements that increase the physical and visual building mass.

Employ color, lighting and material choices in a way that complements surrounding buildings to create a visually appealing composition of solid and transparent materials.

Seamlessly integrate new buildings into the surrounding context while offering variation in material and texture choice, to avoid over-concentration of materials within an area.

Consider providing variety among buildings through subtle details in the curtain wall, and the articulation of a human-scaled base at the street level.



Source: Shutterstock
Prominent or focal building entrances can be incorporated into tower design, to support access and wayfinding, and enhance articulation.



Source: Shutterstock

SHAPING THE SKYLINE

When a tower is proposed for a particularly prominent site, consider design and orientation of buildings that respond to its heightened level of importance. Not all towers warrant a signature feature and individual projects should be evaluated for their potential to function as iconic buildings within the larger Downtown skyline. Generally, iconic buildings transform the composition of the skyline and are located on more prominent sites, providing points of orientation and visual interest within the region. Iconic buildings function as gateways into the district and contribute to a lasting and meaningful public legacy. In most cases, these buildings are the tallest in the district, but may also be lower scale buildings recognizable for architectural creativity and excellence.

Iconic buildings warrant a comprehensive level of review and project applicants are highly encouraged to consult with the Department of City Planning at the conceptual and final design phases of the project. When an iconic building is proposed consider the following guidance:

Highlight the importance of an iconic building's primary entrance with appropriate scale and design. Consider ground floor treatments that contribute to a strong sense of arrival and incorporate unique and recognizable design features.

Delineate a building's top with a change in detail and meet the sky with a narrower form, or tapered overhang. Shape iconic towers with tapered sculptural crowns so as to contribute to the quality and character of the overall Downtown skyline. A flat roof is not recommended.

Consider tower forms that appear simple yet elegant and add an endearing sculptural form to the skyline.

Use simple forms for the building crown to create timeless design that subtly integrates with the overall tower design.

In the same way that iconic towers define and strengthen the skyline during the daytime, thoughtful use of decorative lighting can be used to reinforce the presence of the building at night. Not all buildings warrant decorative lighting. Reserve these features for iconic towers to create a consistent sense of rhythm and identity between day and night.

Integrate lighting with the shape of tower crowns to enhance the tower's presence in the skyline. Residential towers are not required to have crown lighting.

Appendix C

Historic Cultural Neighborhoods Best Practices



Source: Shutterstock

CHINATOWN

INTRODUCTION

Chinatown is characterized by low- to mid-scale residential uses, and commercial and retail services oriented around a system of interior pedestrian streets and plazas. The architecture is predominantly mid-century, although a substantial number of Historic Cultural Resources with architectural features that are common to traditional styles are embedded within this neighborhood. Consequently, architectural features such as complex roof-lines, flared eaves, rafter tails, decoratively carved brackets and projecting balconies stand out against a more subtle mid-century context. The residential component of Chinatown predominantly consists of multi-family units and are present in the form of townhomes, garden courts, or apartments interspersed with single family homes. The urban form includes a variety of building heights ranging from one-story single family homes and retail establishments to multi-family mid-rise buildings.

More recent developments are taller in height and generally line the boundaries of Chinatown. Design elements such as plazas, water features, and public art and murals contribute to the overall character of Chinatown. Guidelines for Chinatown are intended to ensure new infill buildings are compatible with the existing context and complement its historic and cultural identity, while incorporating design, details and materials to form an integrated and interconnected neighborhood. In order to guide new construction and changes to existing buildings which contribute to this condition in a compatible manner, designers can look to traditional Chinese architectural styles and approaches. There are multiple branches of Chinese architectural styles, each with unique design rules that evoke distinct cultural context and connotation. Appendix B provides an overview of these architectural themes, with recommendations and examples of how to pair and apply traditional design elements within a modern context.

■ ■ ■ SITE PLANNING

Intent: An integrated relationship between buildings, streets, and open spaces that contribute to and conserve the prominence of historic and cultural structures.

When located adjacent to buildings of significance, acknowledge their presence through appropriate building setbacks and stepbacks, so as to not overwhelm their importance.

Development along major commercial streets such as North Broadway, North Spring Street and North Hill Street can provide public plazas, interior atriums, and pedestrian passageways to break up large blocks and promote pedestrian circulation through a network of interconnected shops.

Where buildings are set back from the property line, consider designing these areas to accommodate seating or open display of products associated with businesses lining the streets.

Recognize the importance of plazas and similar gathering spaces in this neighborhood. Integrate public pedestrian pathways into new development to create a porous built environment that contributes to further enhancing this neighborhood.

When a project is sited at a strategic location such as at a prominent node or gateway, explore making the site serve as an identifiable icon, landmark, or gateway to the neighborhood.

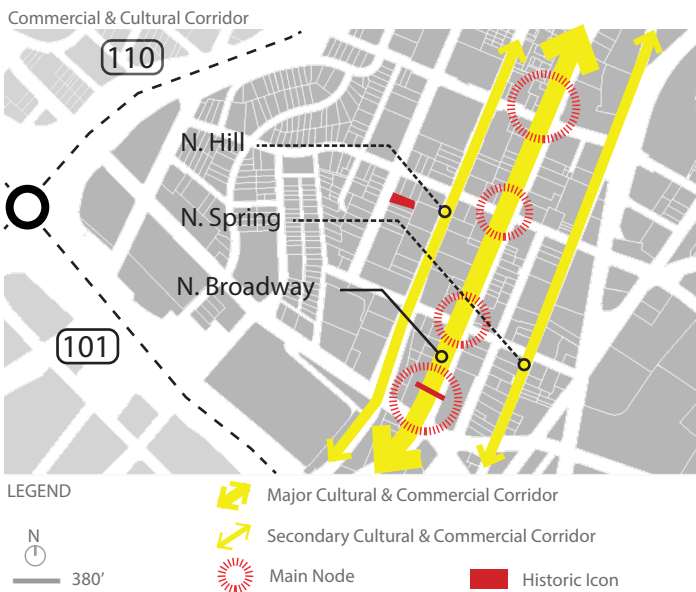

1. N. Broadway serves as the cultural heart of Chinatown with unique local businesses, legacy organizations, and iconic landmarks. Design buildings along N. Broadway to reinforce its identity as a main "Cultural & Commercial Corridor", with a variety of uses and facilitate a network of gathering spaces during cultural and community celebrations.
2. To help promote a vibrant street and neighborhood, N. Hill and N. Spring streets are envisioned to serve as secondary "Cultural Corridors", with more mixed uses.
3. Celebrate buildings and structures at key intersections and corner sites, and utilize opportunities to create visual focus.



The Figure shows a pedestrian oriented cultural commercial corridor in Beijing, China. Features such as clear signage, seating, window displays, and shade have been incorporated to enhance the pedestrian experience.



The Figure shows a vibrant mixed use neighborhood. This image demonstrates how building setbacks can be activated with uses such as outdoor dining, display, and seating.

The image on the right shows design gestures that respond to the prevalent architectural styles in Chinatown.

Projects are encouraged to provide a porous ground floor design with space for open display of products and seating along the sidewalk.



■■■ BUILDING DESIGN AND ARTICULATION

Orient active uses, common gathering spaces, and balconies away from adjacent freeways in order to minimize exposure to sound and air pollution.

Place, orient, and shape building facades to enhance and complement adjacent open spaces.

Incorporate a variety of gathering spaces that meet the needs of a broad range of users, including families with children, seniors, and pet owners.

Design open spaces to include playground, facilities for children, as well as amenities and seating for adults and seniors to promote informal guardianship.

Employ a variety of high quality materials in public spaces that can support a range of activities.

Oriental Activities

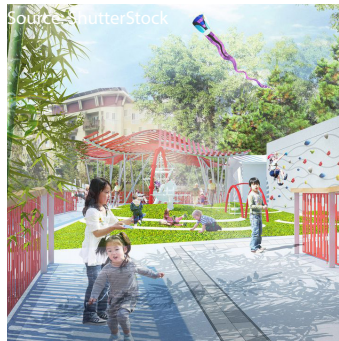

The images above show some common activities, especially popular among seniors: exercising, kite flying, chess, Tai Chi, plaza dancing etc.

Figures A-C show various paving materials. These public places do not need to be large; small to medium sizes are more desirable. Spaces that encourage multi-use spaces through variety in paving material/paving pattern, areas with shade and sunlight, and active play zones for children alongside passive seating areas for adults that support guardianship, are generally preferred.

Intent: Overall building design, articulation, and massing contribute to and strengthen Chinatown's role as a cultural heart of Los Angeles, characterized by buildings which contribute to a memorable and cohesive corridor.

Incorporate prominent entryways, outdoor dining, outdoor display, street furniture, or unique facade treatments to enliven the street along North Broadway.

Utilize architecturally integrated overhangs and canopies, as well as conventional and unconventional landscaping installations to provide shade and reduce heat island effect.

Highlight visibility of small neighborhood serving retail uses when adjacent to residential uses by incorporating identifiable entrances and maximum transparency along street facades.

Visually display public history or background through imagery, text, or plaque displays visible from the public right-of-way.

Create linear continuation, such as a strong cornice line or upper-level step back, to respect similarities with nearby existing structures.

Prominent architecture as landmark - Chongqing Guotai Arts Center



Figure above shows an example of having a prominent building as the landmark. These kind of buildings, as well as Chinese Gardens, that appear at key intersections or street corners, help to form strong mental maps. These buildings serving different uses celebrate aesthetic/cultural features.

Figures D - G show various ways of public display to emphasize historic and cultural identities; Elements like traditional Chinese stone/metal engraving and calligraphy are incorporated into plaques.

Image A source from Shutterstock; Images B - E and G sources from Getty; Image F source: Mafengwo.

ARCHITECTURAL DETAILS AND MATERIALS

Intent: Architectural details and materials echo traditional and modern building function and design in harmony with the existing built environment.

Incorporate thoughtful expression of Chinese architectural design, through the use of varied materials and textures to create patterns and dimension, rather than overt gestures. Building design and material that are internally coherent, and have minimal focal points are appropriate.

Incorporate natural materials, or natural material substitute, such as wood, stone, tile, terracotta, ceramic, and clay brick to add texture.

Consider employing a color scheme that utilizes prominent colors like red as accent colors, rather than as primary facade colors.

Provide paving materials such as tile or stones to create distinctive open spaces and building entrances.

The roof, cornice, or parapet that are visually distinctive and well integrated into the overall design of the building are desirable.

Consider employing signage that has dimensional qualities, to create a layered or stacked effect.

Retain historic signs to help preserve the district's character.

Explore making signage that is multilingual and incorporates locally spoken languages.

Incorporate existing neon signage as part of new buildings to retain this character defining feature of Chinatown.

The figure shows the lighting design in Chongqing, China. Good lighting reinforces the architectural features of a building, improves the district's safety and avoids light pollution. Consider applying lighting along distinctive roof lines, cornices, columns and balconies; to achieve design coherence especially along cultural-commercial corridors like N. Broadway.



Source: Shutterstock
Sino-Ocean Taikoo Li

This figure shows a cultural commercial corridor in Chengdu, China which successfully combines modern and historic design elements.



Source: Shutterstock

Source: Getty

Figure A & B shows durable, three-dimensional signage that incorporates local languages and adds visual interest to the building facade. Use of Chinese calligraphy, as shown in Figure A is also encouraged.

An Ancient Town in Suzhou



Source: Getty

Source: Shutterstock

Source: Shutterstock

The figure shows a color scheme in a traditional village in China: using unsaturated and calm color as basic tone, and darker color for roofs and window frames to create contrast. Note that bright colors are used sparingly and the red color is used only as a highlight to emphasize entrances and direct views. Figures C and D shows the application of red color on street furniture and decorations.





Source: Shutterstock

Image source: bj.wenming.cn

Color and Material Palette

A key component of traditional Chinese design is the selection of building colors and materials, which are often paired together to signify particular meanings or occasions. The application of these elements in contemporary construction can help new buildings integrate harmoniously into Chinatown's existing fabric.

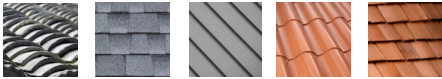
Color & Material Palette

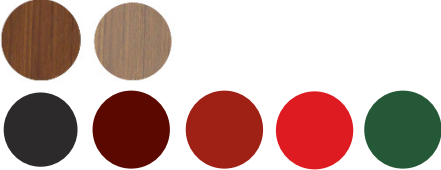
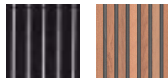
	Color	Material
Roof	 <p>It is customary to use dark colors for roof or ridges, and are often the same color tone as the facade color, but in a different shade. Roof color can include black; Dai (黛, a bluish-black color); dark and light grey; or burgundy, similar to the color of a brick.</p>	 <p>Roof materials can include tile, composed of clay, concrete, glazed, solar, or ceramic tile; asphalt shingles; slate; wood; brick; metal; or a green roof; or similar texture substitutes.</p>
Facade	 <p>The facade is often a soft or tranquil tone, such as white, grey, beige, light yellow, brown, or burgundy, similar to the color of a brick.</p>	 <p>While the facade color is subtle, the facade material can include texture or patterns to create visual interest. This can be achieved through textured concrete; wood or its substitute; masonry veneer, comprised of stone, brick, or tile, or its substitute; metal panels; or glass and its substitutes, which can serve as a good transitional material between modern and ancient architecture styles.</p>
Window & Door Frames	 <p>Dark tones such as a deep red, burgundy, or black can be applied to windows and door frames. New development should avoid applying white to window and door frames.</p>	 <p>Window and door frames can utilize wood, fibrex, aluminum, composite, fiberglass.</p>

Accentuate Color



Minimal but consistent use of color. The color can be used prudently as a method to highlight components of a building or district. Examples of this include red lanterns or other decorations at the entrances to a building, alley, or district; street furniture; and some window frames. Judicious application of the color red can also support other objectives such as pedestrian wayfinding and visual connection.

Transitional Color



Avoid abrupt color combinations. Transitional color and tones such as murals between the roof and primary facade material are used as a strategy in traditional Chinese architecture to avoid jarring transitions.

Texture



Texture is the key to success. Appropriate texture/material can play an important role in linking both traditional and modern identities. For more information, please see Material section on the left and Appendix A for application examples.

Image sources: Getty.

Iconic Chinese Features

Detailed descriptions and application see Appendix A, on following pages.

1. Dou Gong

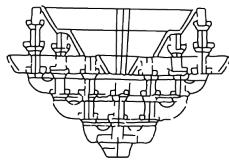

2. Mei Ren Kao

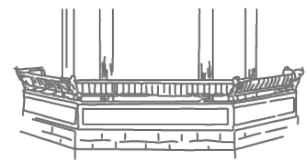

3. Sloped Roofs & Tile Ridges

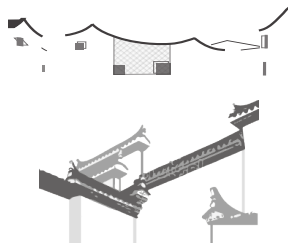

4. Lattice Pattern Windows & Screen Walls

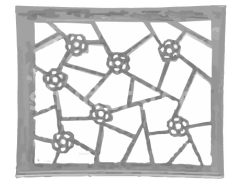

5. Gate House (Men Lou)



6. Moon Gate

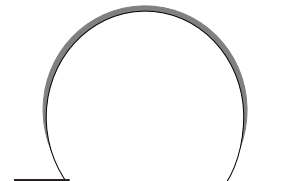

APPENDIX A

Iconic Chinese Architecture Design Features For Inspiration

Applying Identifiable Traditional Chinese Architecture Elements into Modern Architecture (referencing Neo-Chinese/Contemporary Chinese Style: Xinzhongshi (新中式建筑))

Below are traditional Chinese architectural approaches that cohesively integrate traditional elements with modern building design, to achieve both functionality and aesthetic beauty.

Contemporary structures which have incorporated these traditional elements successfully (新中式建筑) have done so through simplified and appropriately abstracted building structures, allowing the traditional elements to shine, as the main accentuating feature of the building. The following sections provide a selection of precedents and best practices.

1. Dougong

Dougong is an interlocking set of wooden brackets, traditionally utilized as supportive and decorative structure. The use of Dougong first appeared in buildings of the late centuries BC and evolved into a structural network that joined pillars and columns to the frame of the roof. As an iconic and identifiable structure in traditional Chinese architecture, it can be innovatively adapted to modern buildings.

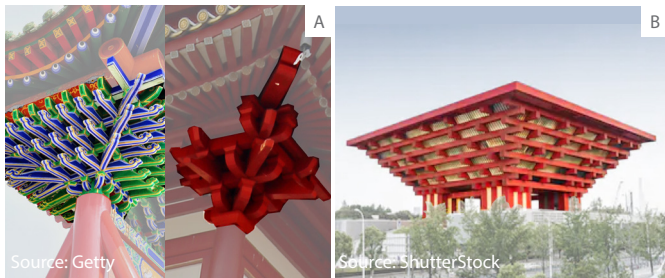

Figure A shows two examples of traditional Dougong structure, one with intricate colors and layering and the other more simplified.

Figure B is the China Pavilion Exhibition Hall, constructed in 2010 during Expo in Shanghai. This is an example of Dougong inspired architecture, which combine both the iconic geometry and rhythm of Dougong, with modernism. However, consider the building mass and surrounding environment to contextualize the application of such features.

As demonstrated in image B above, designers are encouraged to reinterpret Chinese architectural elements to a modern architectural vernacular.

2. Mei Ren Kao

Mei Ren Kao (“beauty leans on”), a long linear bench that functions as both seating and parapet. It is commonly seen in the upper floor hallway, pavilion and corridor of traditional Chinese buildings. It can be appropriately modified and applied to new buildings to better connect the interior and exterior space transitions, provide resting spaces for elderly users, and offer views of the cityscape.



Figure C & D show different ways of applying Mei Ren Kao, a kind of bench, in traditional Chinese architecture. In some cases, the benches can also combine with a low retaining wall.

Mei Ren Kao can be incorporated into new buildings to function as a balcony and support businesses like bars, tea houses and restaurants. This design element also helps connect the indoor and outdoor spaces, and the upper floors to the street.

Image sources from Shutterstock.

3. Sloped roofs & tile ridge

List A below identifies four of the more common types of traditional Chinese roofs. Although sloped roofs are not necessary in Los Angeles due to dry climate, and minimal rain and snow, they are an identifiable feature due for their unique rhythm and can easily evoke the identity of Chinese design. Designers may consider incorporating a variation of the sloped roof to fit a contemporary building's overall design.

The eave is another common characteristic of Chinese architecture, which is applied as a linear cap on walls and screen walls. These can be utilized in contemporary design to define the shape of a building and function as an accent.

Below images show several ways of reinterpreting the sloped roofs and eaves in modern architecture design.



Figure A shows a modern cultural commercial corridor project. Asymmetrical, slightly sloped roofs reflect the rhythm of traditional precedents, complement the variation in window shapes and facade texture and add visual interest.



Source: Yingshi Huang.

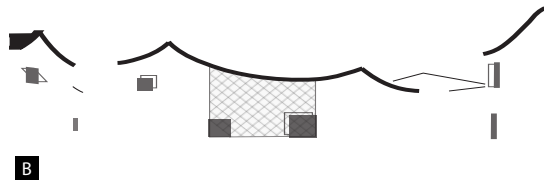

Figure B. The sloped roof is slightly curved to create a modern expression of a traditional design feature.

4. Lattice Pattern Windows & Screen Walls

Decorative window frames and screen walls are used throughout traditional Chinese architectural and landscape design to separate interior and exterior environments.

Contemporary buildings can incorporate lattice pattern windows and walls in numerous functional ways: 1) to articulate building facade and break up blank walls (Figure C); 2) bring in daylight to the interiors through semi-permeable walls (Figure D); 3) to create separation or sense of privacy between indoor and outdoor spaces, or to screen patio areas (Figure E); 4) to frame focal points (Figure F).

Chinese screen wall patterns typically employ cultural meanings. Thus, precedent study in advance is necessary.



Source: Shutterstock

Source: Shutterstock

Wood panel on facades

Wood lattice for passive design



Source: Shutterstock

Source: Shutterstock

Wood lattice to separate spaces

Screen walls to guide views

List B: some traditional lattice pattern categories include:

- Square (grid, diamond, overlapping-diamond)
- Circle (round mirror, moon, coin, fan)
- Chinese Characters (ten (十), secondary (亚), relates to sacrifice ceremony & means noble, field (田), work (工),
- MISC (foliage, animals, etc.)

5. Gate House (Men Lou)

Gate House elements are commonly used in Chinese traditional design. It originated from the Han dynasty and has evolved for thousands of years. It can be placed on the wall of a garden, a temple, or at the entrance of a street.

Gate house is usually viewed as the “face” of the family or the owner, thus varies largely based on size, height, structure, style, decoration, and material etc. Some modern Chinese-inspired architecture use Gate House element directly on the building facade to create focal point, add visual interest or indicate an entrance. Most of these buildings function as restaurants or commercial uses.



Figure A & B give examples of a Gate House.

6. Moon Gate

In Chinese tradition, the full moon is a symbol of peace, prosperity, and family reunion. The moon gate is a common element used in Southern Chinese Garden design. The gate is often used to connect two adjacent spaces; it functions as a frame, to mediate and guide one’s attention toward a particular view, such as a focal point in the garden. The circular moon can be sometimes substituted by a similar shape, such as an octagon.

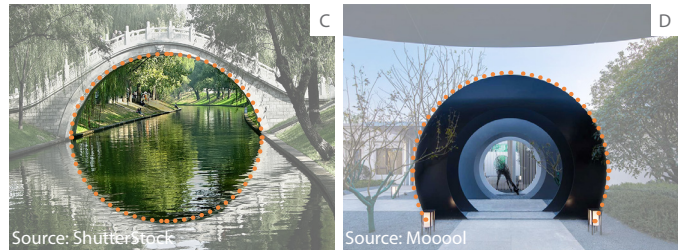

Figure C & D shows the full moon shape in traditional Chinese design. In modern design, the shape can be used creatively in various locations.

Figure C shows an example of a moon gate simulated using a reflective surface.

Texture Application Examples



Image sources: Shutterstock.

Incorporating appropriate textures and architectural details can reinforce the identity and enhance the visual quality of this neighborhood.

These examples show Chinese Embossments: Metal panel on wall; stone lions at entrances; carved wood cornices.



Image sources: Shutterstock.

Texture & Identity: Two examples demonstrate the use of different textures to reflect both traditional and modern identities.

■ ■ ■ APPENDIX B
Interpreting Modern Precedents

Case Study: Sino-Ocean Taikoo Li, Chengdu, China



Source: Shutterstock
 Sino-Ocean Taikoo Li



Source: Shutterstock
 Sino-Ocean Taikoo Li

The Sino-Ocean development, completed in 2014, is an example of Neo-Chinese Architecture, a winner of ULI’s 2015 Global Award for Excellence, and a LEED ND Gold–Certified development. The large-scale retail heavy development is located between a thousand-year old structure, the Daci Temple, and the most prosperous commercial and financial district in Chengdu, Chunxi Road. The development meets sustainability objectives by applying architectural fins on the facade and roof eaves for solar shading, and by employing computational fluid dynamics (CFD) analysis to inform the building orientation study and improve its surrounding micro-climate.

The development also bridges the cultural and aesthetic gaps between ancient Chinese architecture and modern skyscrapers, by selecting and thoughtfully abstracting traditional design elements into the development’s design. The development simplifies Southeastern Chinese roof designs, to visibly reflect traditional roof rhythms, where roofs sit at varying elevations and setbacks. The development also reflects local texture and color theme, through the use of materials such as wood panels, bricks, tile roofs, and subdued colors such as the lime wall.

In sections of the development with more active commercial and retail activity, the designers have incorporated contemporary glass walls. These establish high levels of transparency on the ground floor, allowing for more natural light (Chengdu is famous for its gloomy climate), which reflect the modern characteristic of the context accurately while also providing each business more opportunity to play with interior designs and lighting. This modern innovation is viewed as successful, due to the traditional roof lines and materials throughout the rest of the development.



Source: Shutterstock

Modern material: contributes to a modern identity; responds to surrounding tall building context; activates street frontages and highlights commercial use.



Source: Shutterstock

Cultural identity is reflected through material and shapes; eaves in different elevations mimic ancient towns and adds visual interest.

Interpreting Traditional Precedents: Three Architecture Classes

There are mainly three classes in traditional Chinese architecture. Though new buildings are not encouraged to mimic traditional buildings, an understanding of the underlying theories and correlated elements are important to avoid meaningless and extravagant designs.

New building designs are encouraged to reflect Chinese identities, however, also consider sustainability, durability and functionality to avoid designs that are economically and environmentally inefficient.



Northern Vernacular Style

Northern Vernacular Style

This image shows an example of the Northern vernacular architecture, where the building has been designed with a dark grey tile roof, a light grey brick facade, and a white lime facade for the overall color tone. Northern China has extreme winters, resulting in a natural landscape that is often barren. To infuse color and vibrancy into this context, the Northern vernacular architecture includes wooden windows and doors that are often painted in dark red or green, and sometimes the wood frames remain unpainted. Many buildings in the Northern Vernacular Style also include murals, featuring scenes or landscapes with cultural meanings. These murals are oftentimes green or blue in general, and located under the roof or cornice.



Southern Vernacular Style

Southern Vernacular Style

An iconic example of Southern vernacular architecture is Hui Style (徽派). This style incorporates dark grey tile and white lime facade to establish a muted tone. The windows and doors are traditionally made from wood, which are left unpainted or painted with dark red or grey. Careful introduction of color and texture forms a clean and neat aesthetic.



Royal Architecture Design

Royal & Religious Architectural Design

In ancient China, only royal palaces included yellow roofs. Other royal related and religious structures could use yellow-green, green, or green-grey roofs. This is in contrast to other types of buildings, which were limited to grey roofs. The facade of Royal or Religious structures were typically red, and in particular instances were painted green. Similar to those murals found in the Northern Vernacular Style, royal and religious structures would often feature murals under roofs and upon the cornice. These mural paintings are typically a green or blue tone. Royal & Religious structures were traditionally the only buildings that include dragons in the mural design.

Chinese Architecture Spirit

When all elements and components of a building tell a cohesive story, demonstrate a fluent rhythm and express a unified spirit, they are often successful. If intending to reflect traditional Chinese Architecture spirit, here are a few references to choose from:

- "Harmony between universe and human" (天人合一,因地制宜)
- Sense of ordinance: stately and magnificent (Northern Royal theme)
- Sense of relaxation, romance, freedom and philosophy (Southern Chinese Garden style)
- Sense of prosperity, auspicious and lively (vernacular theme)



ARTS DISTRICT

INTRODUCTION

The built environment of the Arts District reflects its history as a terminus of three major railroads and a center of industrial activity. High ceilings, large openings and open interior spaces later lent themselves for the reuse of these structures as live-work units, artist lofts and production uses. The predominant character in the Arts District is an industrial structure generally built prior to the 1930's. Features such as unrefined façades, durable materials such as concrete, steel and brick, large glass openings and exposed building structures, provide a visual continuity throughout the neighborhood. Large, open, unpolished and flexible interiors found throughout the district have accommodated the artisan and manufacturing uses which make the community distinct. Elements such as abruptly ending streets, and occasional loading docks in place of sidewalks, define the neighborhood's streetscape. The guidelines below are intended to direct new buildings to adopt site planning and building design principles that would help retain the unique industrial character and urban form of this neighborhood, while facilitating the reuse of old structures. It is the goal of these guidelines to foster buildings that respect and respond to the building typology in the District, but not mimic them.

■ ■ ■ SITE PLANNING

Intent: Retain the unique industrial character of this neighborhood by incorporating narrow non-vehicular pathways, consistent street walls and large floor plates to ensure the massing of new buildings are compatible with the prevailing historical building pattern. Consider the following best practices to reinforce the character of this neighborhood and highlight its industrial period:

Sites with significant remnants of the neighborhood’s past such as rail spurs are encouraged to incorporate them into site planning to express a narrative of the site’s history.

Lots that are located around the 6th Street Viaduct to the east of Mateo Street and bounded by 4th Street to the north and 7th Street to the south, can signal their proximity to the Los Angeles River through appropriate building orientation.

River adjacent properties can engage the riverfront by orienting the site’s open spaces to the river. During site plan development, also consider orienting primary active uses towards the river to allow for a permeable relationship with the riverfront.

Provide paseos and passageways that connect with adjacent streets and alleys to break up large blocks and promote pedestrian circulation.

Placement of buildings that support public views to the River, are encouraged, so that east-west streets continue to provide visual connections to the River.

Where an adjacent street intersects with the building’s property line, align paseos and building breaks to extend the path of travel.

When locating a tall building next to a historic structure, consider employing architectural massing strategies such as step-backs to respect the prominence of the historic structure.

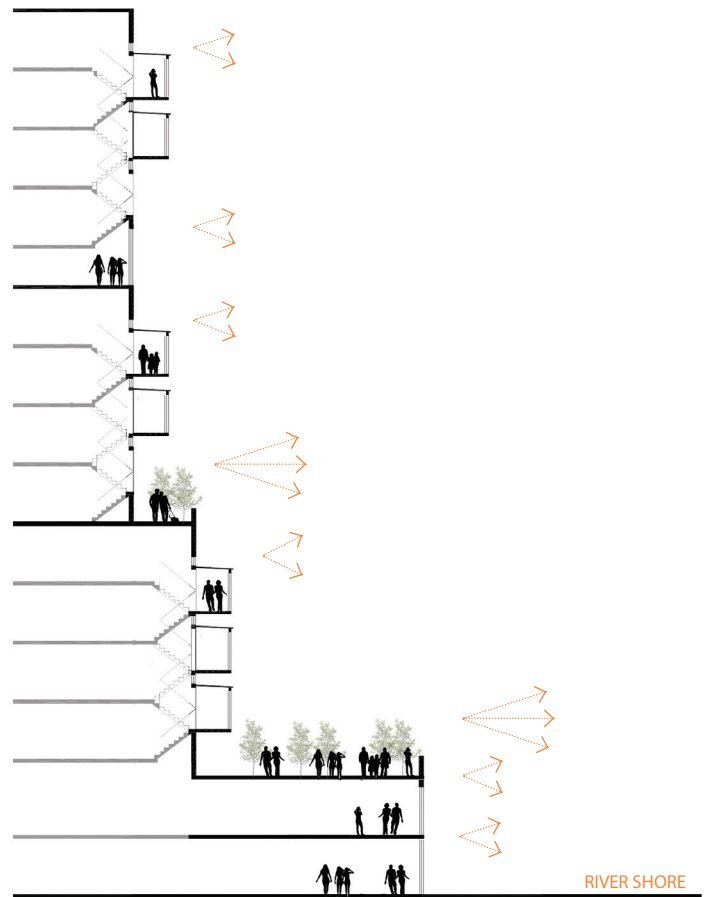

Tall buildings' visual access to river

The diagram illustrates how buildings can maximize visual access to the river. Visual connections can be achieved through innovative massing techniques, higher levels of transparency, or commonly accessible patios.

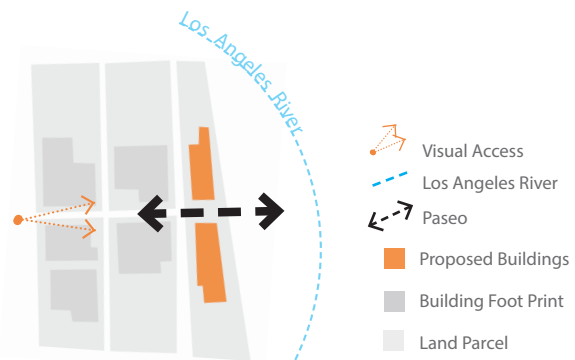

Site planning to guarantee visual access to river

This diagram shows how site planning can ensure visual access to the river. Paseos are encouraged to break-up long buildings and avoid visual barriers. Paseos should align with existing street grids to extend public views and offer visual connections to the river.

■ ■ ■ BUILDING DESIGN AND ARTICULATION

DESIGN CONFIGURATIONS

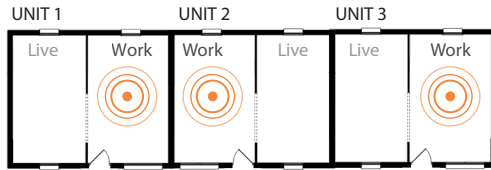

Floor plan example for live/work units

This configuration locates work spaces of adjacent units next to each other, minimizing noise from work spaces to the quieter living areas of a live/work unit.



Floor plan example for live/work units

This configuration reduces sound transfer between units by buffering work spaces with bathrooms, closets, and kitchens.

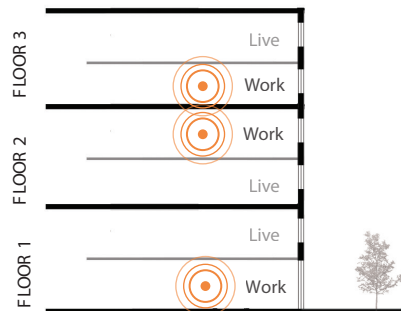

Configuration example for Loft units

This configuration illustrates vertical placement of live/work units. The work spaces share a common floor plate and act as a buffer between living spaces.

Intent: Ensure new developments retain the industrial character of the neighborhood that are typically expressed in two parts - large windows to allow daylight to the interiors and wide openings to allow for handling equipment. Including character defining features such as high ceilings, large doors and windows, high-quality durable materials and minimalist exterior facades is generally appropriate. Design spaces for vertically integrated businesses where possible, to support coexistence of onsite production, manufacturing and retail. Consider the following best practices:

Properties along the Los Angeles River that incorporate engaging facade treatments such as balconies and large transparent openings are desirable.

Design interior spaces with minimal structural walls to create flexible open spaces and allow for changing uses over time.

Where awnings are proposed, utilize sturdy materials and integrate them with the overall building design.

Incorporate windows, doors, and openings that are larger than typical standard sizes, particularly along the first two floors to maximize daylight access and facilitate movement of goods and equipment.

Transom windows are encouraged, where appropriate.

Considering design and configuration strategies to minimize sound transfer between live/work units.

1. Thoughtful design and activity configurations can help reduce transfer of sound between adjacent units.

2. Sound transfer can also be minimized through material choice and appropriate design of windows, doors, walls, ceilings and floors.



This image shows an example of large transom windows and doors, which reflect the district characteristics.



These images illustrate how historic rail features can be incorporated into the design of both active and passive spaces. These features can serve many functions such as wayfinding or public art.

■■■ ARCHITECTURAL DETAILS AND MATERIALS

Intent: Promote the use of high-quality materials and bare ornamentation that allow for a clear expression of the structural elements on exterior facades and contribute to the industrial character of the neighborhood.

Buildings are encouraged to avoid nostalgic ornamentation, “tacked-on” materials, and fake reproductions.

Expose the structural elements of a building to allow for a visual expression of the building’s composition on the exterior facades.

Utilize robust non-residential finishes on the interior spaces that can also withstand manufacturing uses.

Consider incorporating public art, murals, and greenery along the exteriors of a building.

Design roofs, cornices, or parapets to be visually distinctive and integrate these features into the overall design of a building.

Consider incorporating lighting that is responsive to human scale in addition to those that highlight architectural features.

Appendix D

Public Realm Best Practices

TABLE OF CONTENTS

01 INTRODUCTION AND OVERVIEW	2
02 LIVABLE AND SUSTAINABLE DOWNTOWN	3
03 SIDEWALKS	4
04 ALLEYS	9
05 ON-SITE OPEN SPACE AND LANDSCAPING	11
06 STREETScape IMPROVEMENTS	14
07 PUBLIC ART	19
DEFINITIONS	21
APPENDICES	22

SECTION 1

INTRODUCTION

Downtown Los Angeles is developing as a more livable and resilient community. To sustain this growth, good choices must be made at all levels of planning and design - from land use and development decisions to building massing and materials choices - with an emphasis on walkability and the making of great streets, districts, and neighborhoods.

This document supplements the provisions of the Los Angeles Municipal Code as well as the Urban Design and Neighborhood Character chapters of the General Plan Framework and Downtown landscape, open space, and public space. It also stipulates that future development respect and complement those distinct physical characteristics present throughout Downtown's neighborhoods. These best practices also emphasize designing for pedestrian orientation and multi-modal development. To this end, the document has been created to carry out the common design objectives that maintain neighborhood livability while promoting design excellence, and creative and sustainable infill development solutions.

The content outlined in this document builds upon the goals of the City's General Plan, the Downtown Community Plan, and augments the zoning code regulations, and helps to shape the relationship between built form, land use, and the public realm. It also supports sustainable development practices and innovations, including the utilization of solar power and electric vehicle charging capabilities, particularly as technology supporting such uses improves over time.

SECTION 2

GOALS FOR A LIVABLE AND SUSTAINABLE DOWNTOWN

To promote a more livable Downtown, projects must address a mix of housing, employment, retail, and entertainment opportunities supplemented by a rich network of transit options, gathering spaces, and recreation areas, and address sustainability at multiple levels. The design of the street, buildings, and landscape must work in tandem to achieve the most effective results.

This begins with the design of the built environment, which guides the way that pedestrians and users experience their communities. Individual projects should be recognized as the building blocks of great streets and neighborhoods; this requires particular attention to the way the buildings meet the sidewalk. New development must engage the public realm to ensure that the built environment can support a dynamic and safe urban street life in Downtown.

As a counterpart to the Downtown Community Plan policies and zoning regulations for each site, this Best Practice Document provides direction for building design to achieve this vision.

BUILDING DESIGN PRINCIPLES

The following Building Design Principles are intended to help shape public and private development, and promote sustainable design, connectivity, and placemaking.

1. **Pedestrian First.** As the most intense and dense part of the City, Downtown's greatest assets are its streets and public spaces. Buildings are designed to contribute to a safe, inviting, and human-scaled public realm that prioritizes walkability.

2. **Transit Oriented and Accessible.** Downtown is at the center of a regional serving transportation system with investment planned for future additional infrastructure. The built environment signals this asset with buildings and streets that support a broad range of transit riders, including commuters, the disabled, youth, and elderly populations, to easily access the system.

3. **A Place Where All Spaces Matter.** Every new development is an opportunity to contribute to a more dynamic and inviting place. As such, all spaces matter. Whether facing a street, alley, river, freeway, or in a historic setting, all building elements, including placement, massing, and facade, are thoughtfully designed.

4. **Adaptable.** The built environment should be sustainable and adaptable over time. New development exhibits effective and creative solutions to move toward zero-carbon buildings, utilizing renewable materials, alternative energy sources, and stormwater management strategies

5. **Identifiable Neighborhoods.** There are a range of distinct neighborhoods and districts that are identifiable because of a distinct built environment, mix of land use, or historic legacy. New buildings and thoughtfully adapted structures are welcomed into an existing built environment in a manner that respects local development patterns.

6. **Healthy Urban Environment.** As the area grows and development intensifies, it is increasingly important to maintain a balance between the urban environment and wellbeing. All development, including buildings, streets, landscaping, and infrastructure is designed to promote health and comfort for all individuals.

7. **Comfortable Spaces to Move Through and Stay In.** Streets and open spaces, such as plazas, parks, and roof decks, are integrated into the built environment so that they function as one seamless network for individuals to move through and stay in.

8. **Dynamic and Recognizable Skyline.** Downtown is located in the heart of the City, and framed by two significant topographic features; the Los Angeles River and the San Gabriel Mountains. Downtown's skyline continues to evolve and coalesce into a rhythm that builds upon its surrounding topography and is recognizable from any vantage point

SECTION 3 SIDEWALKS

A. SIDEWALKS

In accordance with the Complete Streets Design Guide of the Mobility Plan 2035, the Sidewalk Zone is divided into two primary zones:

- The Walkway Zone, which is located adjacent to the property line and provides a clear path of travel for pedestrians and may accommodate outdoor dining and other commercial activity if there is adequate width.
- The Parkway Zone, which is located between the Walkway Zone and the face of curb, and may include the parkway, convenience strip, and the curb itself.

The Downtown Street Standards establish required sidewalk widths for all Downtown streets. On many streets, the required sidewalk width is a combination of public right-of-way (dedication) and easement for sidewalk purposes.

Design sidewalks that are walkable and accommodate a variety of uses in the Walkway Zone.

1. Provide the sidewalk width required by the Downtown Street Standards through sidewalk easements.

To provide flexibility in building design and at the same time provide space for sidewalk activity, the required sidewalk easement may be averaged. The easement provided on any section of the project frontage may range from zero feet to 3 times the required easement width, provided that the total area of the easement divided by the length of the property frontage equals the required average. The area of an easement beyond 3 times the required easement width may not be counted towards the required square footage of the average easement area.

2. A building may project horizontally up to a maximum of 5 feet over the required sidewalk easement at a minimum vertical height of 40 feet above the sidewalk to accommodate street trees. Projections, which are permitted in the public right-of-way (ROW) by the LAMC (Section 91.3202), such as signs, canopies and awnings, are permitted over the required easement, subject to the same approvals. In areas with taller tree canopies, portions of the building may only project above a height of 100 feet. See IMAGE A below.
3. Provide a Walkway Zone with a 4foot wide continuous path of travel pursuant to California Code of Regulations, Title 24, for compliance with Americans with Disabilities Act (ADA) accessibility requirements. See IMAGE B below.
4. Outdoor dining may occur on any portion of the paved sidewalk provided it does not obstruct the minimum required continuous path of travel. Any dining within the right-of-way will require approval of a revocable permit from the Bureau of Engineering. See IMAGE B below.

IMAGE A: Example of building overhang that does not interfere with street tree growth.



IMAGE B: Example showing the parkway along the curb, the clear path of travel and use of the remaining sidewalk for outdoor dining.



Design sidewalks that incorporate green elements and collect stormwater through the Parkway Zone.

5. Sidewalks should provide both minimum Walkway Zone and Parkway Zone widths as listed in Table 3-1.

Table 3-1. SIDEWALK WIDTH REQUIREMENTS (in feet)		
SIDEWALK WIDTH	WALKWAY ZONE (minimum)	PARKWAY ZONE* (minimum, includes curb)
8	4	4
9	5	4
10	6	4
11	6	5
12	6	5
13	6	5
14	6	7
15 or wider	6	7

*Parkway Zones may contain tree wells or parkways. As defined by DPW, a tree well is 12 feet or less in length, and a parkway is any landscaping longer than 12 feet in length. Parkways must be planted, and tree wells must be either planted or include a walkable surface.

6. Directly adjacent to curbside parking, provide an 18-inch wide convenience strip with a walkable surface next to the 6-inch curb. Walkable surfaces include, but are not limited to, decomposed granite, permeable pavers, and plants that can withstand pedestrian traffic (see Section 9.H.7. for example plants). If no curbside parking or loading is provided, the convenience strip is not required. The convenience strip is not required to wrap around parkways or tree wells, but must be provided through driveways and should end at the edge of the “detectable warning dome” mat in the ADA ramp area.

Design continuous parkways to accommodate and support large street trees and to collect stormwater, where feasible.

7. Provide continuous landscaped parkways, except in locations determined to be inappropriate for parkways, such as in the Historic Downtown or adjacent to bus stops. The continuous landscaped parkways should be designed to collect and retain or treat runoff from, at a minimum, the sidewalk and, if approved by BOE, adjacent on-site, ground level open space in accordance with Low Impact Development (LID) Ordinance requirements. See IMAGE A below.
8. Where there is curbside parking, provide one 3-foot wide walkway or walkable surface for every two parking spaces. The walkway should provide pedestrian access from the sidewalk through the parkway to curbside parking.
9. Parkways should be sloped downward to the center of the parkway to form a shallow swale to collect sidewalk stormwater. Alternative means of storing runoff, such as gravel sumps within the parkway, may be provided. A vertical drop of 4 inches or greater is not permitted.
10. The roots of trees planted in the parkway should not be restricted by concrete curbs, root barriers or other means within the parkway, so that roots may extend throughout the parkway and support a large, healthy tree canopy. As such, street light conduit, meter boxes, and other subsurface utilities should be located either 1) in the walkway zone, or 2) adjacent to back of curb within the parkway.
11. All plantings should be installed per BOE standards. If parkways are designed to collect stormwater from the street as well as from the sidewalk, they should be designed according to the BOE Green Streets guidelines or standards.

See IMAGE B below.

IMAGE A: All continuous landscaped parkways should collect stormwater runoff from the sidewalk.



IMAGE B: Parkway can be designed to filter stormwater runoff from the street. If there is a raised curb around the parkway as in this example, the convenience strip next to the curb must be wider than 18 inches.



Where continuous parkways are not feasible, provide large street tree wells with gap-graded soil beneath the sidewalk.

12. If trees are not planted in continuous landscaped parkways, they should be planted in large tree wells and either planted or covered in decomposed granite. The tree well should meet the minimum size requirements from the BSS Urban Forestry Division (UFD), with minimum Parkway Zone widths provided as listed in Table 3-1 and at least 10 feet in length.
13. For each tree well having less than 100 square feet of surface area, gap-graded or other means of uncompacted soil should be provided within 20 feet of any street tree under the entire sidewalk from back of curb to the property line to allow for tree root growth. See IMAGE A below.
14. Where average 24-foot wide sidewalks are required by the Downtown Street Standards, at least 50% of a project's frontage should have sidewalks at least 22 feet wide and a second row of street trees should be provided. The interior row of trees should generally be in large tree wells, and each tree should be spaced 20 feet from any tree in the Parkway Zone. See IMAGE B below.
15. Where tree wells and parkways would conflict with existing basements, underground vaults, historic paving materials, or other existing features that cannot be easily relocated, the tree well and parkway design should be modified to eliminate such conflicts. See IMAGE C below. Parking meters and signs are examples of existing features that can be easily relocated. Digital copies of maps showing existing basements in the public ROW are available from BOE.
16. Slope tree wells downward to the center as specified in BOE Standard Plan S-450.

IMAGE A: Tree with large tree well surrounded by permeable paving with gap graded soil to store and infiltrate stormwater beneath.



IMAGE B: Where average 24-foot wide sidewalks are required, as on Grand Avenue in South Park, a double row of trees is also encouraged



IMAGE C: Where narrow sidewalks or basements prohibit in-ground trees, planters may be used.

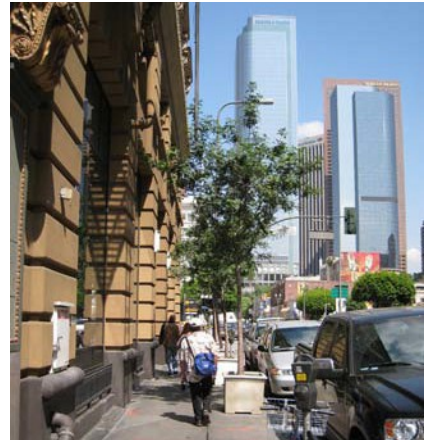
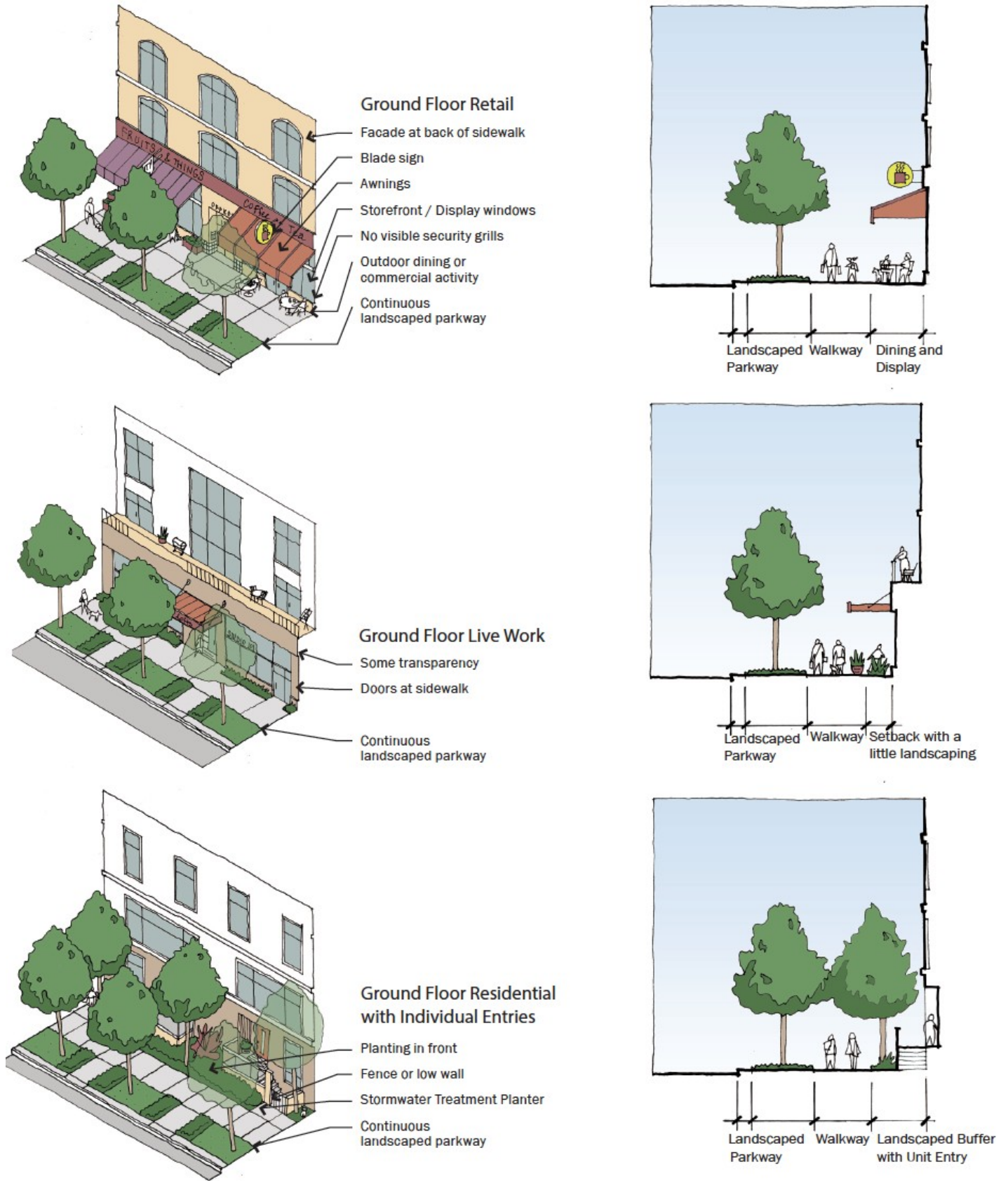

Figure 3-1 Sidewalk treatment varies with ground floor treatment. Images are for illustrative purposes only to show relationship between sidewalk treatment and elements.



SECTION 4

ALLEYS

A. ALLEYS AND BUILDING WALLS FACING ALLEYS

Maintain and enhance alleys.

1. All alleys should be open to the public at all times. To maintain public access and activity, Downtown alleys should not be gated. Existing gates should be removed where feasible. Alley vacations should be avoided unless:
 - Vehicular access to the project is provided only at the former intersection of the alley with the street;
 - Vacating the alley will not result in the need for additional curb cuts for other parcels on the same block;
 - An easement is provided along the alley width that allows for an enhanced alley improved and maintained by the Applicant.

Use alleys primarily for vehicular access, loading and service. See IMAGE A on the following page.

2. Where an alley exists or can be provided, primary access to parking should be from that alley, with minimal curb cuts from the street frontage.

Where appropriate and in accordance with City Low Impact Development (LID) requirements, projects should enhance existing alleys with green elements in mind to assist in stormwater capture, retention, and infiltration.

3. Alleys should be surfaced with high-albedo paving or surface treatments, recycled and/or locally manufactured “green” paving surfaces in lieu of asphalt to reduce the heat island effect.
4. To eliminate standing water and infiltrate stormwater, projects should install permeable paving surfaces along the centerline of the alley, or along the perimeters of the alley (depending on existing water flow). See IMAGE B on the following page.
5. For stormwater capture and infiltration, projects should incorporate one drywell minimum with a grease interceptor downstream at the lowest point of the alley. Additional drywells are recommended for every 100 linear feet of upstream drainage area, and may be interspersed along the central drainage swale of the alley.
6. To treat stormwater, incorporate a biofiltration system such as bioswales into the alley design.

Where appropriate, enhance existing alleys with pedestrian orientation in mind. Alleys can be enhanced as “shared” alleys for both pedestrian and vehicular use, or as “pedestrian-priority” alleys for pedestrian-only use. See IMAGES C and D on the following page.

7. Provide enhanced smooth-surface paving treatments within pedestrian pathways along shared alleys to create pedestrian-friendly scale.
8. Where enhanced alleys intersect the sidewalk, provide a combination of raised, above-ground, or at-grade planters on either side of alley entrance to soften the alley entrance from vehicular traffic and sound.
9. Provide a combination of permeable pavers or raised planters to define the entrance of any residences, businesses, or other active uses along the alley.
10. Provide ornamental or pedestrian lighting in the form of pole-mounted lighting fixtures or building-affixed sconces to illuminate the alley walkway, focal features, building entrances, and other amenities and add security.
11. Provide enhanced articulation, building entrances, and primary internal circulation cores along facades facing the alley.
12. Where alleys are intended as “pedestrian-priority” alleys, they should be enhanced further with pedestrian

orientation in mind, such as:

- ADA-compliant walkways with the required minimum path of travel and delineated with smooth-surface permeable pavers;
- Connection to at least one gathering space or focal point; and
- Clear line of sight to the back of the alley, gathering space, or focal point.

13. Provide pedestrian furniture or placemaking elements including but not limited to murals, art installations, gardens, green space, and other enhancements to improve the functionality of the alley

Provide access to utilities and mechanical equipment from alleys.

14. Electrical transformers should be located to be accessible from an alley where one exists or can be provided. If located adjacent to a sidewalk, they should be screened and incorporated into the building to read as a storefront or office.

Design building walls that face alleys to be attractive.

15. Building walls that face alleys should be visually attractive with well-maintained articulated facades and durable building materials. Stucco should be avoided on the ground level of abutting walls.

16. Residential units should not be located on the ground floor adjacent to alleys except along shared or pedestrian-priority alleys in order to reduce light, glare, and noise concerns from the use of alleys for parking access, service, and loading.

IMAGE A: A typical Downtown alley is primarily used for vehicular access and loading.



IMAGE B: Typical alley with permeable paving along the center flowline to infiltrate runoff and eliminate standing water.



IMAGE C: Santee Alley is a pedestrian-priority alley.



IMAGE D: Shared alley that is primarily pedestrian with resident/delivery vehicular access.



SECTION 5

ON-SITE OPEN SPACE AND LANDSCAPING

Downtown's open space network is comprised of a series of smaller interconnected open spaces distinguished by design and function to create a connected pedestrian realm. These open spaces range from public and private uses, including public amenity spaces, common open spaces, and private open spaces, and are collectively conducive to both active and passive uses. Determinations of open space and floor area should be implemented in a manner that maximizes opportunities for resident and public-serving open space, such as on rooftops, balconies, and building cutout areas, taking into account limitations on developable space that constrain many downtown development projects.

A. OPEN SPACE NETWORK

1. Establish a clear hierarchy of open spaces which may include the following typologies:

- **Streets.** Streets, pedestrian-oriented alleys, and enhanced driveways are the most public of all open spaces. When enhanced for multi-modal connections and designed as livable spaces, they communicate the quality of the public environment and the care a city has for its residents.
- **Paseos.** Paseos are extensions of the street grid located on private property. As outdoor passages devoted exclusively to pedestrians, they establish clear connections among streets, plazas and courtyards, building entrances, parking and transit facilities.
- **Entry forecourts.** Entry forecourts announce the function and importance of primary building entrances. They should provide a clear, comfortable transition between exterior and interior space.
- **Courtyards.** Courtyards are common open space areas of a scale and enclosure that is conducive to social interaction at a smaller scale.
- **Plazas.** Plazas are common open space areas typically amenable to larger public gatherings. They are readily accessible from the street, as well as active building uses.
- **Corner Plazas.** Corner plazas should be an appropriate in scale (intimate for residential, larger for commercial) and be programmed with specific uses (to provide outdoor dining for an adjacent restaurant, or small neighborhood gathering place featuring a public amenity). Unprogrammed or over-scaled corner plazas are discouraged.
- **Roof and Podium Terraces.** Roof terraces and gardens can augment open space and are especially encouraged in conjunction with hotels or residential uses.
- **Atriums.** Atriums are central open spaces in the interior of larger buildings, generally covered or enclosed by glass and used for passive recreation and social interaction.
- **Arcades.** Arcades and through-building paseos should be an appropriate scale (at minimum with double height ceilings) and be partially open to the sky or transparent.
- **Building cut-outs.** Often used to create sky gardens, cut-outs and openings should be designed to create visual interest in the building massing and provide a comfortable, usable open space.

2. Design flexible public amenity spaces that can support a range of uses including seating, lounging, conversing, window-shopping and dining, playing, or special events programming such as farmers markets and art exhibits.

B. GUIDELINES FOR ALL OPEN SPACES

3. All open spaces should provide ADA-compliant walkways to ensure ease of access for all users.
4. All open spaces should include or connect to at least one gathering space or focal element. Additional gathering spaces and focal elements are encouraged for larger open spaces or open spaces with meandering walkways.
5. Non-movable or fixed seating should be placed with consideration to noontime sun and shade; deciduous trees should be planted as the most effective means of providing comfortable access to sun and shade.
6. On above-grade open spaces including roof or podium terraces, building cut-outs, or residential courtyards, incorporate trees and other plantings in permanent and temporary planters that will shade, reduce reflective glare, and add interest to the space.
7. Landscape elements should support an easy transition between indoor and outdoor space through such means as well-sited and comfortable steps, shading devices and/or planters that mark building entrances, etc.
8. Landscape elements should establish scale and reinforce continuity between indoor and outdoor space. Mature canopy trees should be provided within open spaces, especially along streets and required setbacks.
9. Landscape elements should provide scale, texture and color. A rich, coordinated palette of landscape elements that enhances the Development Site's identity is encouraged.
10. Landscaping should be used to screen or break up the mass of blank walls. For example, trees and shrubs may be planted in front of a blank wall where there is room or vines may be trained on the wall where space is limited.
11. Open spaces should be designed with the character of outdoor rooms contained by buildings by providing architectural features on any adjacent building walls.

IMAGE: On-site open space should be designed to serve a building's residents.



IMAGE: Projects that provide publicly accessible open space at-grade may receive a reduction in the on-site open space requirement.



IMAGE: Good example of a commercial corner plaza.



IMAGE: Good example of a roof terrace.



IMAGE: Seating is an essential element in most open spaces.



IMAGES: Landscaping can take a variety of forms.



IMAGE: Open space and streets should be designed to accommodate a variety of activities and events.



SECTION 6

STREETSCAPE IMPROVEMENTS

Streets are a defining feature of the public realm, serving a suite of benefits that allow for travel, commercial activity, and social interaction. As the City continues to expand and invest in its infrastructure, city agencies must coordinate with Applicants and property owners to enhance the streetscape realm, create attractive environments for walking, biking, and transit, and ultimately foster a vibrant public realm in Downtown Los Angeles.

A. RESPONSIBILITIES OF THE CITY AND OTHER PUBLIC AGENCIES

- Recognize the shared use of streets not just for moving traffic, but equally as 1) the front door to businesses that are the economic and fiscal foundation of the City and 2) outdoor open space for residents and workers in a city that is severely lacking in public open space. That is, recognize that all streets on which residential or commercial development is located are “pedestrian-oriented streets” and design and improve them accordingly.
- Implement the standards and guidelines in this document that pertain to improvements within street rights-of-way, including sidewalk configuration and streetscape improvements.
- For improvement projects undertaken by public agencies, comply with the Downtown Street Standards and all standards and guidelines in this document, including sidewalk width, sidewalk configuration and streetscape improvements. In the case of sidewalk width, acquisition of rights-of-way or easements from adjacent property may be required.
- Do not unreasonably burden property owners, developers and business owners with complicated regulations and protracted processes.

B. RESPONSIBILITIES OF THE APPLICANT

- Provide sidewalks, parkways and walkways as specified in Section 3.
- Install and maintain the improvements specified in this section. Street trees should be provided in conjunction with each project.
- Execute a Maintenance Agreement per Revocable Permit process requirements with the City by which the Applicant agrees to maintain the streetscape improvements and accepts liability for them. For improvements abutting other properties other than the project site, consent from the abutting property owner may be required by DPW.
- If providing pedestrian lighting, install the pedestrian lighting as specified in Section 6 and agree to an on-going assessment by the City to maintain and operate the lights.

C. IMPROVEMENT TYPES AND GUIDING DOCUMENTS

There are several policy documents that propose streetscape and public realm improvements for the Downtown area including the Broadway Streetscape Master Plan, Little Tokyo Community Design Overlay, and the Los Angeles Sports and Entertainment District. Another such document is the ConnectUS Action Plan. The ConnectUS Action Plan is a conceptual policy document prepared by the Los Angeles County Metropolitan Transportation Authority, in partnership with Downtown communities, which identifies types of potential streetscape improvements with the goals of improving access and mobility between districts, enhancing pedestrian and cyclist safety, and better connecting Union Station to surrounding areas.

The ConnectUS document serves as a guide for improving the public right-of-way, including the sidewalk and roadway, in these areas. Streetscape projects and/or private development projects in this area should refer to the plan for public realm improvement ideas for incorporation into changes in the public realm. The plan identifies three types of

improved streets for the area, mapped in IMAGE A below. These improvement types are: esplanades, walk bike streets, and walk streets and include different pedestrian and bicycle improvements.

1. Esplanades are comprised of a buffered path at sidewalk level with physical separation of pedestrians, bikes, and cars.
2. Walk Bike Streets provide a physical barrier between a bicyclist and moving vehicles as well as enhanced pedestrian features.
3. Walk Streets consist of enhancements mainly for safety and comfort of pedestrians.

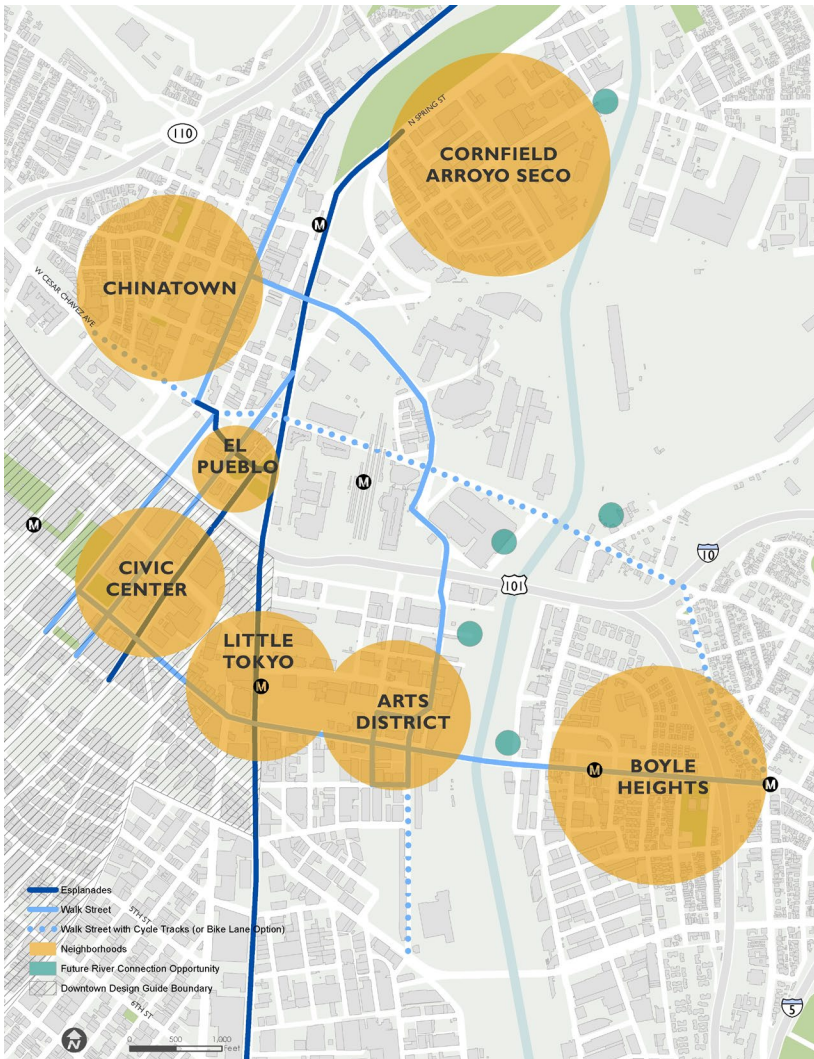

IMAGE A: ConnectUS within the Downtown Community Plan area.

D. STREETSCAPE PROJECT APPROVAL AND PERMITS

Streetscape project approval results in the issuance of a permit by the Department of Public Works. Three different types of permits are issued for streetscape projects, each with varying levels of review. Projects are reviewed for consistency with general City standards and specifications for projects in the public right-of-way. The following is a description of the types of permits required for Streetscape projects.

- **A-permit.** The A-Permit is the first level of street improvement permits and is issued over the counter with no project plans. Items typically permitted through this type of review are new or improved driveways and sidewalks. A nominal fee may be charged for plan check, filing, and inspection.

- **Revocable Permit.** Revocable Permits are the second or mid-level of street improvement permits. Projects requiring approval through the Revocable Permit process include improvements within the public right-of-way that do not change the configuration of the street. Revocable permit applications require the submittal of professionally prepared drawings on standard City (Bureau of Engineering) drawing sheets and are reviewed by the various Bureaus within the Department of Public Works for safety and liability issues. Improvements approved through the Revocable Permit process are maintained by the permittee. Failure by the permittee to keep the improvement in a safe and maintained condition allows the City to revoke the permitting rights at which point a permittee is requested to restore the street to its original condition. A moderate fee is assessed for plan check, administrative filing, and inspection and the Applicant is typically required to provide proof of liability insurance.
- **B-Permit.** The B-Permit is reserved for streetscape projects requiring the highest level of review. A B-Permit is usually issued for improvements that change the configuration of the street, traffic patterns, or other substantial permanent changes to the streetscape. Approval through the B-Permit process is required for projects that are permanent in nature and developed to a level that allows the City to maintain the improvement permanently. Projects subject to the B-Permit review process require professionally prepared drawings submitted on standard City (Bureau of Engineering) drawing sheets and are reviewed by all public agencies affected by the improvements. A fee commensurate with development is assessed for plan check, administration, and inspection. Construction bonding is required to ensure that the improvements are installed, and various levels of insurance are required.

E. CONSISTENCY BETWEEN OLD ENTITLEMENTS AND CURRENT STANDARDS

1. Where previous entitlements differ from current Streetscape standards, compliance with current standards should be flexible but meet the overall intent. When applying this guideline, the City shall take into account the existence of any vested rights pursuant to vested entitlements, such as a vesting tentative tract map and/or a development agreement.
2. Required sidewalk widths must be provided by sidewalk easements, which must be designed as needed to match the improvements on the remaining sidewalk.

F. STREET TREES

Tree Species and Spacing

1. Street tree species should be selected per the Master Street Tree List in Appendix A unless otherwise approved by UFD.
2. Street trees should be spaced not more than an average of 30 feet on center to provide a more-or-less continuous canopy along the sidewalk.
3. Spacing from other elements should be as specified by the UFD.
4. Interspace varied street tree species along the sidewalk to ensure net benefits of continuous canopy and shade, aesthetics, and environmental benefits. Required street trees should be shade trees. Palms may be planted between or in addition to required shade trees.
5. Trees should achieve a mature height, given site conditions, of at least 40 feet on Boulevards and Avenues and 30 feet on other streets with a mature canopy that can be pruned up to a height of 14 feet. Typically, street trees will achieve about two-thirds of the mature height specified in Sunset Garden Book.

IMAGES: Streetscape improvements will vary by district and project. While street trees are sufficient for some areas (top 2 images), more substantial landscaping in the form of parkways along cultural institutions (bottom left) or planter barriers along public facilities (bottom right) is appropriate.

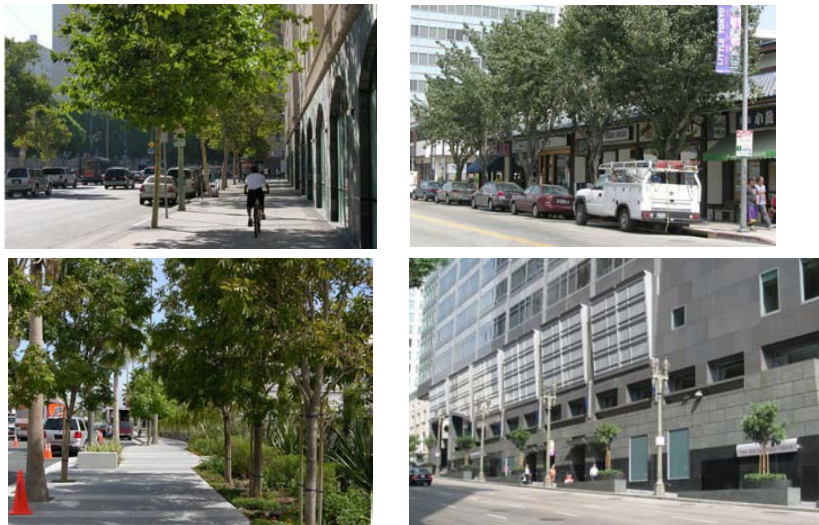

Planting Standards

6. Plant minimum 36-inch box trees within parkways or tree wells as specified in Section 3. Smaller-sized trees such as 24-inch box trees may be planted along Parkway Zones that are less than 4 feet wide, or as required by UFD.
7. Parkway should be planted with drought-tolerant plants. Drought-tolerant plants that qualify as walkable surfaces include, but are not limited to, *Achille millefolium* (Yarrow), *Buchloe dactyloides* UC Verde (UC Verde Buffalo Grass), *Carex praegracilis* (California Field Sedge), *Carex pansa* (California Dune Sedge), and *Dymondia margaetae* (Dymondia) as listed in BOE Residential Parkway Landscaping Guidelines. Drought-tolerant plants may not be more than 2 feet tall. The areas within 2 feet of tree trunks or adjacent to curbside parking or loading should be free of low-level planting as specified in Section 3. Tree wells may be planted with drought-tolerant walkable plants as listed in 9.H.7. Tree wells that are not planted with low-level plants should be covered with decomposed granite per Standard Plan S-450.
9. Where gap-graded (structural) soil is encouraged by Section 3, it should be installed to a depth of at least 30 inches below the required miscellaneous base material under the concrete sidewalk within 20 feet of any tree trunk centerline and for the entire length and width of the sidewalk adjacent to the project, except: 1) gap-graded soil is not required under driveways and 2) adjacent to existing buildings, the existing soil should be excavated at a 2:1 slope away from the building wall or as required by the Department of Building and Safety to avoid shoring of the building footing.
10. Irrigate the trees and landscaped parkways with an automatic irrigation system. In-line drip irrigation is preferred. Spray heads or bubblers installed per DPW standards may also be used provided they do not directly spray the tree trunks.
11. Maintain and prune street trees as specified by the Urban Forestry Division, including: obtain a permit prior to pruning and adhere to International Society of Arboriculture (ISA) Tree Pruning Guidelines and American National Standards Institute (ANSI) A300 standards. “Topping” and “heading” of street trees are prohibited.

IMAGES: Topping and heading is discouraged.



I. STREET LIGHTS

There are two types of street lights in the Downtown: roadway lights (“street lights”) and pedestrian-scale lights (“pedestrian lights”). See IMAGES A and B below. Street lights provide illumination of both the roadways and sidewalks to the levels required by the BSL for safety and security. Pedestrian lights are ornamental and do not contribute to the required illumination level, but they may supplement it. Pedestrian lights contribute to the pedestrian scale of the street and add a warm glow of yellow light on the sidewalk.

1. On streets having an established historic street light, continue the predominant street light pattern, modified as required by BSL to meet current illumination standards, using replicas of the historic street lights as specified by BSL. If a project includes roadway widening, refurbish and relocate the historic street lights with supplemental replicas as required by BSL.
2. In other locations, pedestrian street lights, as approved by BSL, should be attached to each existing roadway light and a matching pedestrian light on a pole approved by the BSL should be installed approximately equidistant between the roadway lights. Pedestrian light spacing must be carefully coordinated with street tree planting in order to meet BSL spacing requirements and maintain the required tree spacing. An alternative street lighting pattern may be approved by BSL.
3. Pedestrian street lights may be set back from the curb on wide sidewalks installed on private property as follows:
 - Where sidewalks are at least 24 feet wide, the pedestrian lights may be set back between the clear path of travel and the commercial activity zone adjacent to the building.
 - Where the building is set back from the sidewalk, the pedestrian street lights may be installed on poles directly adjacent to the back of sidewalk.
 - All light sources should provide a warm (yellow, not blue) light of metal halide or high-pressure sodium or, preferably, LED lights that produce a similar quality of light.
 - All optic systems should be cut-off.
 - Street light conduit should be placed directly at back of curb to avoid conflict with root balls.



IMAGES A: Street lights.



IMAGES B: Pedestrian lights.

J. OTHER UTILITIES

1. When required, install parking meters and traffic signs 20 inches on center from the curb face.

SECTION 7

PUBLIC ART

Historically, cities embrace the arts of their time, and the character, personality and spirit of the city is often conveyed most vividly through its arts and culture. Downtown stakeholders have a proven commitment to the arts, for they play a significant role in cultivating livable neighborhoods. As a result, Downtown is a popular destination to experience public art, art galleries, museums, and theater and to celebrate cultural traditions in enhanced urban settings. For these reasons, public art in Downtown should aspire to meet the following goals and guidelines:

A. GOALS

Integrate public art in the overall vision of the project's architecture, landscape and open space design by incorporating the artist into the design team early in the process. See IMAGES A, B, and C below. The goals are as follows:

- **Artistic excellence.** Aim for the highest aesthetic standards by enabling artists to create original and sustainable artwork, with attention to design, materials, construction, and location, and in keeping with the best practices in maintenance and conservation.
- **Image.** Generate visual interest by creating focal points, meeting places, modifiers or definers that will enhance Downtown's image locally, regionally, nationally and internationally.
- **Authentic sense of place.** Enliven and enhance the unique quality of Downtown's diverse visual and cultural environments. Provide meaningful opportunities for communities to participate in cultural planning, and a means for citizens to identify with each other through arts and culture in common areas.
- **Cultural heritage.** Foster common currency for social and economic exchange between residents, and attract visitors by ensuring that they have access to visual 'clues' that will help them navigate and embrace a potentially unfamiliar environment. This can be achieved through promotional materials and tours as well as artwork.
- **Responsiveness.** Without formally injecting art into the early stages of the planning process for each new development, it will either be left out, or appear out of sync with the overall growth of the built environment.



IMAGE A: Icons and emblems. Large-scale signature sculptural statements and gateway markers can create a dramatic first impression of a neighborhood.



IMAGE B: Civic Buildings. Public facilities require public art that can embody the agency's mission while providing a more human and welcoming face to visitors.



IMAGE C: Plazas. Plazas should be activated with more prominent, enigmatic artwork such as large sculptures, arbors, lighting or water features which include adequate space for people to gather and amenities to make it inviting.

B. GENERAL BEST PRACTICES

1. All artwork erected in or placed upon City property should be approved by the Department of Cultural Affairs, and in some cases, may require a special maintenance agreement with the appropriate BID or similar community organization.
2. Artwork in privately owned developments should be fully integrated into the development's design, in the most accessible and visible locations. Enclosed lobbies and roof top gardens are considered appropriate locations.
3. Artwork in retail streets and developments will need to be viewed in relation to existing signage and shop frontage.
4. Attention must be paid to how the artwork will appear amidst mature landscape.
5. Special care should be made to avoid locations where artworks may be damaged, such as the vehicular right-of-way.

C. CONTRIBUTING TO AN URBAN TRAIL

Ideally, each Downtown neighborhood would develop an aesthetic "heart" with unique characteristics. It could be represented by a neighborhood boundary, main boulevard, business core or cultural corridor. The art that defines the heart can also branch out to offer connections that form an "Urban Trail." This trail could provide physical and visible connections using elements such as:

- Icons and emblems;
- Civic buildings;
- Street furnishings;
- Plazas;
- Parks, paseos and courtyards;
- Façades; or
- Transit hubs.

IMAGE A: Parks, Paseos and Courtyards. These spaces allow for closer, quieter contemplation of art, and can provide playful sequential elements.



IMAGE B: Façades. An artist's sculpted or surface treatment can become a visual showcase that complements the architecture.



IMAGE C: Transit Hubs. Strategically located artworks can serve as beacons to attract people to transit, and to make a commuter's wait more interesting.



DEFINITIONS

Whenever the following terms are used in the document, they should be construed as follows.

Convenience Strip. An 18-inch wide strip with a walkable surface, located behind the 6-inch curb to provide access to curbside parking where there is a non-walkable planted parkway or tree well.

LEED®. The Leadership in Energy and Environmental Design (LEED) Green Building Rating System™ is the nationally accepted benchmark for the design, construction, and operation of high performance green buildings. See the official website www.usgbc.org for more information.

Parkway. The unpaved portion of a Sidewalk (Border) between the face of curb and walkway (per Mobility Plan 2035). Includes convenience strip, if provided.

Parkway Zone. Sidewalk zone reserved for streets, other landscaping and access to parked cars.

Pedestrian-Priority Alley. Alleys enhanced with pedestrian-oriented design, including pedestrian pavers, street furniture, pedestrian lighting, and landscaping.

Primary Entrance. Entrance which provides the most direct access to a building's main lobby and is kept unlocked during business hours.

Public Amenity Space. Publicly-accessible open spaces that are generally located at grade, containing seating, landscaping, and focal element or gathering spaces that are open to the general public.

Sidewalk. The portion of the ROW between the face of curb and property line, including the Walkway Zone and Parkway Zone (per Mobility Plan 2035). (Not as defined by BOE "the portion of the roadway primarily for the use of pedestrians.")

Street Standards Committee. The Street Standards Committee consists of representatives from the Department of City Planning, Department of Transportation and Bureau of Engineering and is tasked with the responsibility of establishing street standards and applying them to streets within the city.

Walkable Surfaces. Surface treatments that include, but are not limited to, decomposed granite, permeable pavers, and plants that can withstand pedestrian traffic. Drought-tolerant plants that qualify as walkable surfaces include, but are not limited to, Achille millefolium (Yarrow), Buchloe dactyloides UC Verde (UC Verde Buffalo Grass), Carex praegracilis (California Field Sedge), Carex pansa (California Dune Sedge), and Dymondia margaetae (Dymondia), as listed in BOE Residential Parkway Landscaping Guidelines.

Walkway. The paved surface of the sidewalk located in the Walkway Zone.

Walkway Zone. The portion of the Sidewalk ("Border") containing a continuous path of travel used primarily for walking and, where there are no bicycle lanes, for bicycling. May also accommodate outdoor dining and commercial activity if there is adequate width.

Zoning Code. The planning and zoning provisions of the Los Angeles Municipal Code (LAMC), Chapter 1 as amended.

APPENDICES

APPENDIX A

Master Tree List

APPENDIX B

Alley Enhancements

APPENDIX A

MASTER STREET TREE LIST

A. OVERVIEW

A lush urban canopy is essential to a vibrant, sustainable, and livable Downtown. Street trees are a vital part of Downtown's infrastructure, providing environmental, ecological, social, as well as aesthetic benefits. Trees are key players in the storm water capture and filtration system and also aid in reducing the heat island effect by providing shade along sidewalks and streets. Street trees are also essential in fostering neighborhood character and pedestrian activity. Canopy trees are ideal in Downtown as they provide shade along city sidewalks to facilitate pedestrian activity and also mitigate air pollution along major roadways.

B. LIST OF APPROVED STREET TREES

The following street tree species have been selected from the Urban Forestry Street Tree Selection Guide in coordination with landscape architects and the South Park Business Improvement District, and are deemed most suitable for the Downtown Los Angeles urban canopy. The intent is to foster coherent and sustainable tree plantings that add to neighborhood character, maximize stormwater capture, and facilitate pedestrian activity.

Street trees that are suitable for planting within the public right-of-way in Downtown may include, but are not limited to, the following trees. Other tree species are allowed as permitted upon consultation with the Urban Forestry Division. In the event that a street tree species identified in this document is affected by a disease, insect, or environmental change, the Urban Forestry Division may consider an alternative tree species that is substantially similar to one of the trees identified in the Master Street Tree List.

	SCIENTIFIC NAME	TYPE	TREE WELL	HEIGHT	CROWN SPREAD	SPACING	DROUGHT TOLERANT
African Fern Pine	Podocarpus gracilior	Evergreen	4 x 8	40+	20-40	30-35	
African Sumac	Rhus lancea	Evergreen	4 x 6	20-40	20-40	30-35	Yes
Aristocratic Pear	Pyrus calleryana 'Aristocrat'	Deciduous	4 x 6	20-40	-20	30-35	
Australian Willow	Geijera parviflora	Evergreen	4 x 8	20-40	20-40	30-35	Yes
Black Locust	Robinia pseudoacacia	Deciduous	4 x 8	20-40	20-40	30-35	Yes
Brisbane Box	Tristania conferta	Evergreen	4 x 8	20-40	20-40	30-35	Yes
Bronze Loquat	Eriobotrya deflexa	Evergreen	4 x 6	-20	-20	25-30	
Callery/Ornamental Pear	Pyrus calleryana	Deciduous	4 x 6	20-40	-20	30-35	
Canary Island Pine	Pinus canariensis	Coniferous	4 x 8	40+	20-40	35-40	Yes
Chinese Flame Tree	Koeleruteria bipinnata	Deciduous	4 x 8	20-40	20-40	30-35	
Crape Myrtle	Lagerstroemia Indica	Deciduous	4 x 6	-20	-20	25-30	Yes
Eastern Redbud	Cercis canadensis	Deciduous	4 x 6	-20	-20	25-30	
Evergreen Pear	Pyrus kawakamii	Evergreen	4 x 6	20-40	20-40	30-35	
Green Gem Fig	Ficus microcarpa nitida "Green Gem"	Evergreen	5 x 10	40-60	60-100	40+	Yes
Maidenhair Tree	Ginkgo Biloba	Deciduous	4 x 8	40+	20-40	30-35	
Golden Rain	Koeleruteria paniculata	Deciduous	4 x 8	20-40	20-40	30-35	Yes
Honey Locust	Gleditsia triacanthos inermis	Deciduous	4 x 8	20-40	20-40	30-35	
Hong Kong Orchid	Bauhinia blakeana	Deciduous	4 x 6	20-40	-20	25-30	Yes
Jacaranda	Jacarda mimosifolia	Deciduous	4 x 8	20-40	20-40	35-40	

Lavender Trumpet Tree	Tabebuia avellanedae	Deciduous	4 x 6	20-40	20-40	30-35	
Magnolia Majestic Beauty	Magnolia grandiflora 'Majestic Beauty'	Evergreen	4 x 8	20-40	20-40	25-30	
Magnolia Saint Mary's	Magnolia grandiflora 'St.Mary'	Evergreen	4 x 6	-20	-20	25-30	
Maidenhair Tree	Ginkgo Biloba	Deciduous	4 x 8	40+	20-40	30-35	
New Zealand Christmas Tree	Metrosideros excelsa	Evergreen	4 x 6	-20	-20	25-30	Yes
Purple Orchid Tree	Bauhinia Purpurea	Deciduous	4 x 6	20-40	-20	25-30	Yes
Small-Leaf Tristania	Tristiana Laurina	Evergreen	4 x 6	20-40	20-40	30-35	Yes
Tipu Tree	Tipuana Tipu	Deciduous	5 x 10	40+	40+	35-40	
Western Redbud	Cercis occidentalis	Deciduous	4 x 6	-20	-20	25-30	Yes
White Orchid Tree	Bauhinia V. Candida	Deciduous	4 x 6	20-40	-20	25-30	Yes
Yew Pine	Podocarpus macrophyllus	Evergreen	4 x 6	20-40	-20	25-30	

C. MAINTENANCE OF STREET TREES

1. To accommodate tenant signs below the tree canopy, a street tree's lateral branches may be removed below a height of 14 feet above the sidewalk elevation, provided that: a) no removed branch has a diameter of more than 1/4 of the trunk diameter or 3", whichever is less, and b) the total tree height is 2.5 times the clear trunk height. For example, if the total tree height is 35 feet, the lateral branches along the trunk may be removed below 14 feet. If the total tree height is 25 feet, the lateral branches may be removed below 10 feet.
2. Trees may not be topped or headed back on the sides to expose signs. If a tree is topped or headed back to expose a sign, the tree should be replaced by the sign permit holder or sign owner with a tree equal in size to the topped or headed tree prior to topping or heading.

D. STREET TREE PHOTO GUIDE

African Fern Pine
Podocarpus gracilior



African Sumac
Rhus lancea



Aristocratic Pear
Pyrus calleryana
'Aristocrat'



Australian Willow
Geijera parviflora

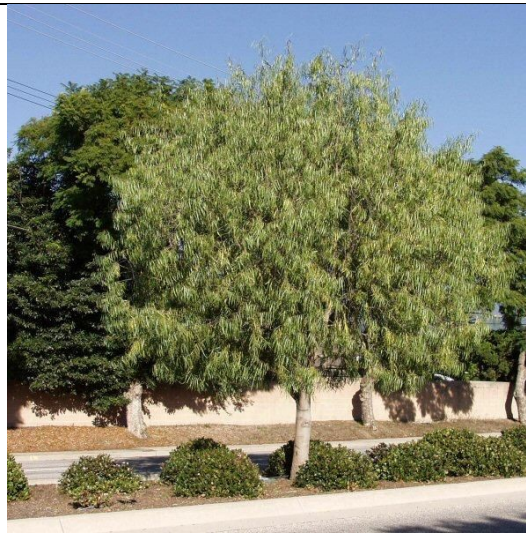

Black Locust
Robinia pseudoacacia



Brisbane Box
Tristania conferta



Bronze Loquat
Eriobotrya deflexa



Callery/Ornamental Pear
Pyrus calleryana



Canary Island Pine
Pinus canariensis



Chinese Flame
Koelruteria bipinnata



Crape Myrtle
Lagerstroemia Indica



Eastern Redbud
Cercis canadensis



Evergreen Pear
Pyrus kawakamii



Golden Rain
Koelruteria paniculata



Green Gem Fig
Ficus microcarpa nitida "Green Gem"



Honey Locust
Gleditsia triacanthos inermis



Hong Kong Orchid
Bauhinia blakeana

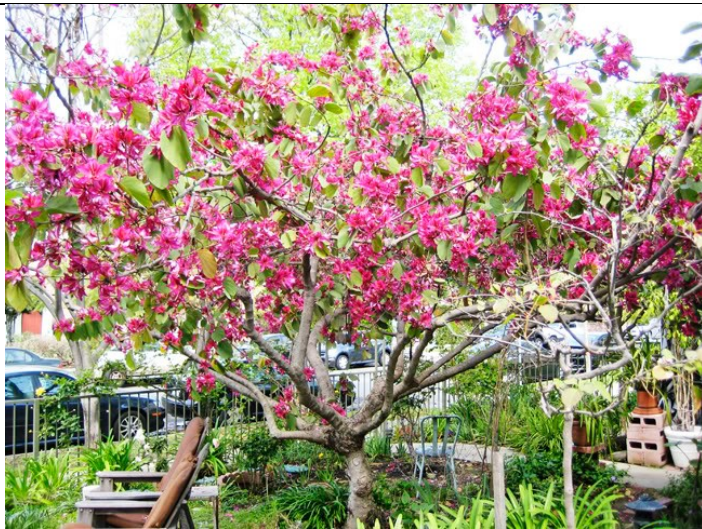

Jacaranda
Jacarda mimosifolia



Lavender Trumpet
Tabebuia avellanedae



Magnolia Majestic beauty
Magnolia grandiflora 'Majestic Beauty'



Magnolia Saint Mary's
Magnolia grandiflora 'St.Mary'



Maidenhair Tree
Ginkgo biloba



New Zealand Christmas Tree
Metrosideros excelsa



Purple Orchid Tree
Bauhinia purpurea



Small-Leaf Tristania
Tristania laurina

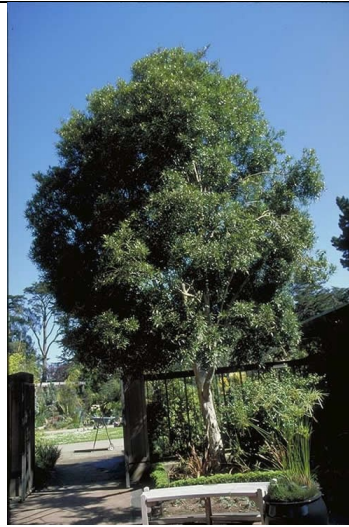

Tipu Tree
Tipuana tipu



Western Redbud
Cercis occidentalis



White Orchid Tree
Bauhinia V. candida



Yew Pine
Podocarpus macrophyllus



APPENDIX B

ALLEY ENHANCEMENTS

The City of Los Angeles is home to over 900 linear miles of alleys, ranging from 10 to 20 feet in width and providing back-of-house access to residential, commercial, and industrial blocks throughout the city.

Typically, alleys are used for back-of-house uses such as providing loading, service, and emergency access to neighboring uses. In the traditional sense, alleys serve important functions for neighboring commercial, industrial, and residential uses such as deliveries, loading, emergency access, parking access, waste collection, and public utilities. These are important functions in the day-to-day operations of a neighboring use.

However, these alleys provide vital opportunities to integrate pedestrian, open space, and stormwater improvements. Especially in dense urban centers such as Downtown, when enhanced with green elements, pedestrian connections, and open space amenities, alleys can provide short cuts for pedestrians, serve as places for gathering and recreation, allow for outdoor dining, and urban greening. Overall, alleys are valuable as they can contribute greatly to the overall social, economic, and physical environment of Downtown. Alleys can serve as important public spaces and vital opportunities for improving pedestrian access, providing open space in park-poor areas, and implementing sustainability strategies.

This appendix also identifies best practices that can shape the improvement of these alleys. For further design guidance on alleys, please refer to the Mobility Element's Complete Streets Design Guide.

A. GREEN ALLEYS

Where appropriate, enhance existing alleys with green elements in mind to assist in stormwater capture, retention, and infiltration.

1. Alleys should be surfaced with high-albedo paving or surface treatments, recycled and/or locally manufactured “green” paving surfaces in lieu of asphalt to reduce the heat island effect.
2. For stormwater capture and infiltration, incorporate one drywell minimum with a grease interceptor downstream at the lowest point of the alley. Additional drywells are recommended for every 100 linear feet of upstream drainage area, and may be interspersed along the central drainage swale of the alley.
3. To eliminate standing water and infiltrate stormwater, install permeable paving surfaces along the centerline of the alley.
4. To treat stormwater, incorporate a biofiltration system such as bioswales into the alley design.

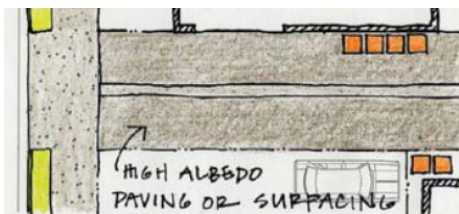

At minimum, where stormwater BMPs cannot be integrated, high-albedo paving or surface treatments or other “green” paving surfaces can reduce the heat island effect.

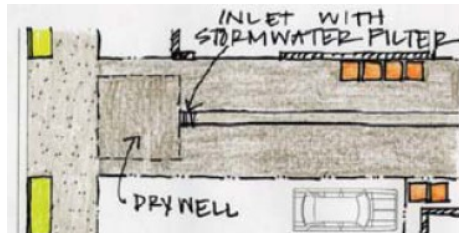

Drywells with grease interceptors should be incorporated for stormwater capture and infiltration

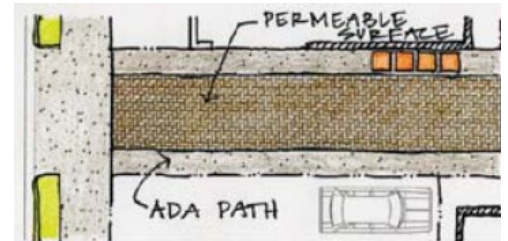

Permeable paving surfaces can be implemented to reduce stormwater runoff and increase infiltration rates

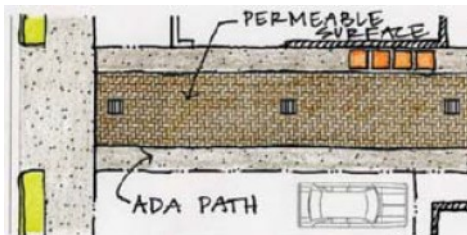

Combining drywells and permeable paving can maximize stormwater capture and infiltration rates

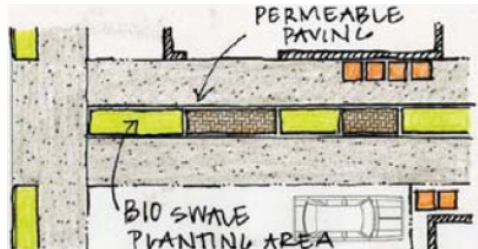

Incorporating a biofiltration system or bioswale can remove and oxidize organic gases

Illustrations (left/above) courtesy of LA Sanitation as part of the Rainwater Harvesting Program: Green Streets & Green Alleys Design Guidelines and Standards

Illustrations (below) courtesy of LA Sanitation and the Trust for Public Land as part of the Avalon Green Alley Network Retrofit Program

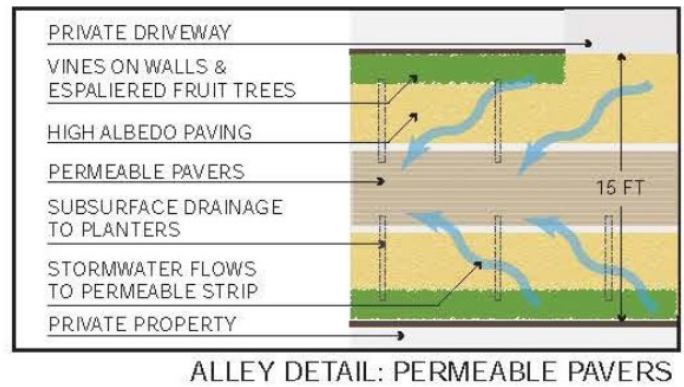
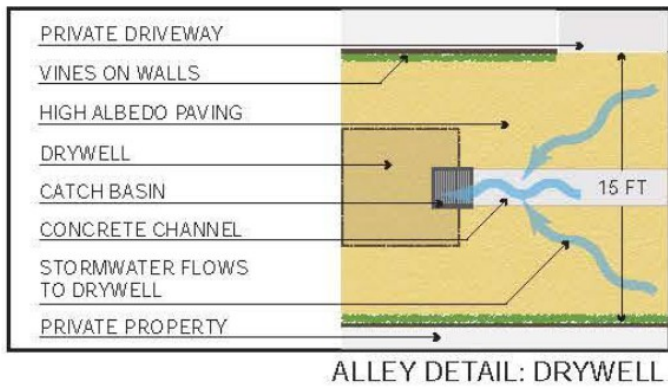

The Avalon Green Alley network in South Los Angeles is a demonstration project for Low-Impact Development (LID) implemented in joint partnership between LA Sanitation and the Trust for Public Land. Two alley segments were identified for full retrofits for stormwater interventions including permeable pavers, dry wells, and rainwater harvesting for plant irrigation.

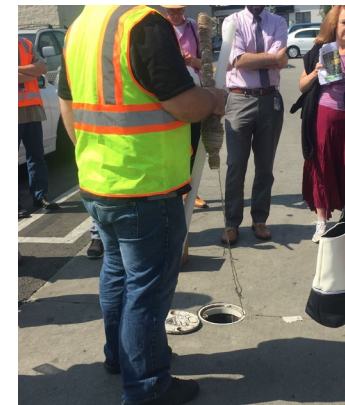

The monitoring wells allow stormwater to collect and be tested for contamination.

A series of drywells, catch basin intercepts, and permeable surfaces were constructed to capture, infiltrate, and retain stormwater runoff from surrounding tributary areas.



The alleys were retrofitted with permeable paving along the alley centerline. The permeable paving sits on top of 2 levels of gravel to allow for adequate drainage and eliminate standing water.

The dry wells are signed as stormwater control measures.

B. SHARED OR PEDESTRIAN-PRIORITY ALLEYS

Where appropriate, enhance existing alleys with pedestrian orientation in mind. Alleys can be enhanced as “shared” alleys for both pedestrian and vehicular use, or as “pedestrian-priority” alleys for pedestrian-only use.

1. Provide enhanced smooth-surface paving treatments within pedestrian pathways along shared alleys to create pedestrian-friendly scale.
2. Where enhanced alleys intersect the sidewalk, provide a combination of raised, above-ground, or at-grade planters on either side of alley entrance to soften the alley entrance from vehicular traffic and sound.
3. Provide a combination of permeable pavers or raised planters to define the entrance of any residences, businesses, or other active uses along the alley.
4. Provide ornamental or pedestrian lighting in the form of pole-mounted lighting fixtures or building-affixed sconces to illuminate the alley walkway, focal features, building entrances, and other amenities and add security.
5. Provide enhanced articulation, building entrances, and primary internal circulation cores along facades facing the alley.
6. Where alleys are designated as “pedestrian-priority” alleys by DCP staff, consider making improvements with pedestrian orientation in mind, such as:
 - ADA-compliant walkways with the required minimum path of travel and delineated with smooth-surface permeable pavers
 - Lined with ground floor spaces designed for active uses along at least 50 percent of its frontage, including retail, restaurants, cultural uses, and/or ground-floor residential units with individual entries directly off of the alley
 - Connection to at least one gathering space or focal point
 - Clear line of sight to the back of the alley, gathering space, or focal point.
7. Provide pedestrian furniture or placemaking elements including but not limited to murals, art installations, gardens, green space, and other enhancements to improve the functionality of the alley.



The East Cahuenga (“EaCa”) Alley is enhanced with permeable paving, outdoor seating, and nighttime lighting.



The East Cahuenga (“EaCa”) Alley is enhanced public art and outdoor seating to create a sense of community identity.

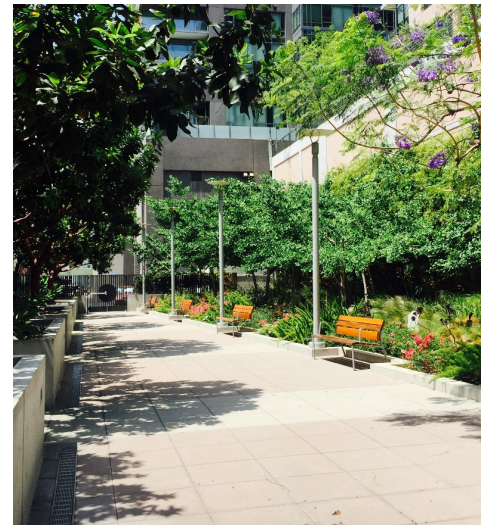

A paseo connects an existing alley to Grand Avenue, and is enhanced with permeable paving, seating, and landscaping.



The Avalon Green Alley provides mini community gardens along the perimeter of the alley to allow for growing of fruit trees. The gardens are irrigated from the rainwater harvested along the alley.



The Avalon Green Alley is signed with the process, purpose, and team involved in the project.



Public art murals are installed along the Avalon Green Alley network to provide a sense of community identity and ownership along the alleys. The murals were created as part of a community engagement process in coordination with a local artist.

E. OTHER RESOURCES

There are several resources available for alley enhancements. Please refer to any of the following resources for further guidance on enhancing alleys.

- Complete Streets Design Guide
- Rainwater Harvesting Program: Green Streets & Green Alleys, Design Standards

Downtown Community Plan Implementation Overlay Appendix E

Downtown Street Standards

DOWNTOWN STREET STANDARDS

CITY OF LOS ANGELES

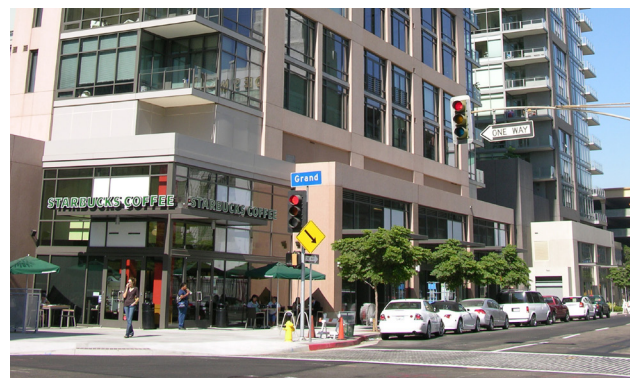

Adopted by City Council
XX, XX, 2021

TABLE OF CONTENTS

PA T A FINAL STREET DESIGNATION CROSS SECTIONS	1
PA T B DETAILED RECOMMENDATIONS	13

HOW TO USE THIS DOCUMENT

The final street designation cross sections found in Part A of this document illustrate required right of way dimensions including minimum sidewalk widths and maximum roadway dimensions. Part A is adopted and illustrates requirements upon which required dedications will be based.

The street cross sections found in Part B of this document provide detailed recommendations for the treatment of specified street segments, including alternative options in some cases. Part B records the detailed recommendations of the Ad Hoc Downtown Street Standards Committee and includes existing (from that time) and proposed widths and lane striping which are recommendations to LADOT.

AMENDMENTS

The Downtown Street Standards include updates to incorporate the street classifications that were adopted by Mobility Plan 2035 in 2015 (CF #), amendments to street designations adopted through the Downtown Community Plan DTLA CPU (CF #).

DOWNTOWN STREET DESIGNATIONS: NORTH - SOUTH STREETS

LOS ANGELES STREET

Modified Avenue I from Temple St - 2ND St
 Modified Avenue II from 2ND ST - Winston St
 Avenue II south of Winston St
 Looking north

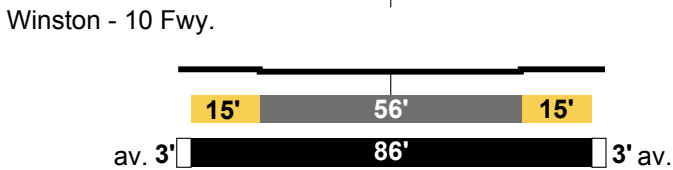
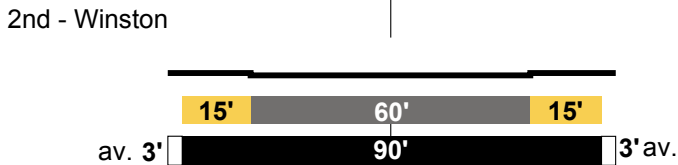
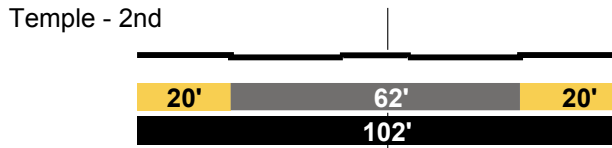

MAIN STREET

Modified Ave I from Temple St - 1ST St; 9TH St to 10 FWY
 Avenue II south from 1ST St to 9TH St
 Looking north

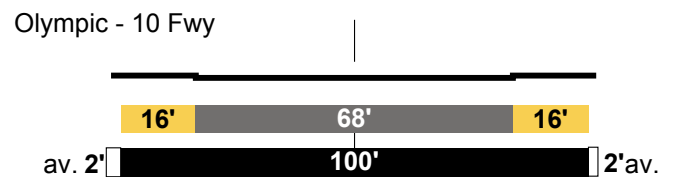
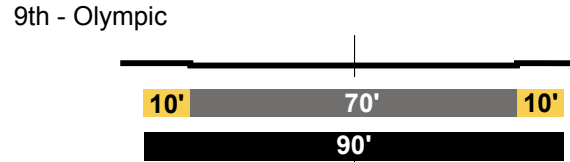
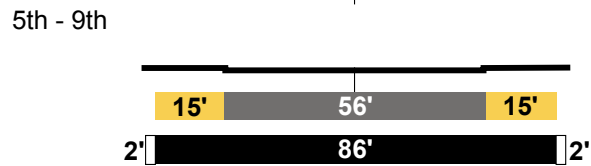
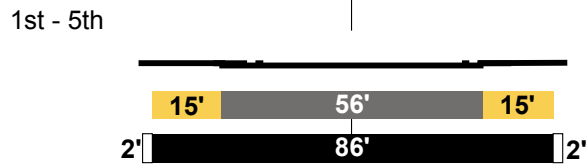
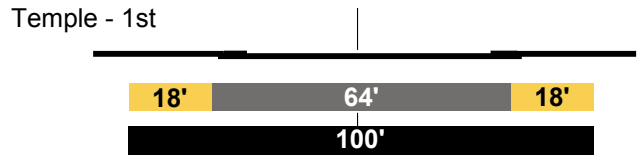

LEGEND - All Cross Sections

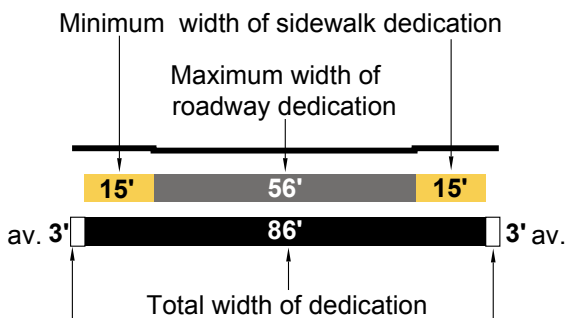

Width of required sidewalk easement
 av. = average easement, which may range from 0' to 3 times the average, provided that the total area of the easement divided by the linear frontage of the property equals the required average easement.

SPRING STREET
 Avenue I north of 1ST St
 Modified Avenue II from 1ST St to 9TH St
 Looking north

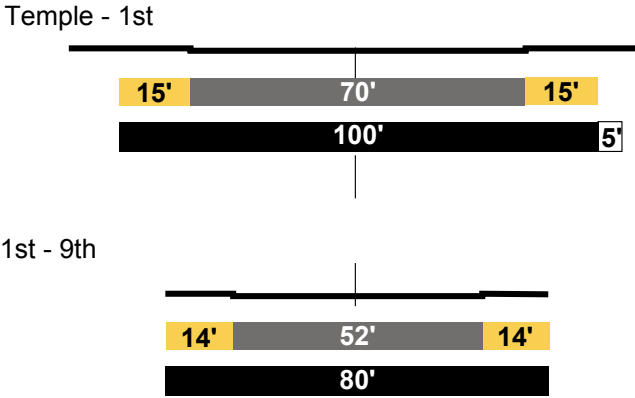

HILL STREET
 Modified Avenue II
 Looking north

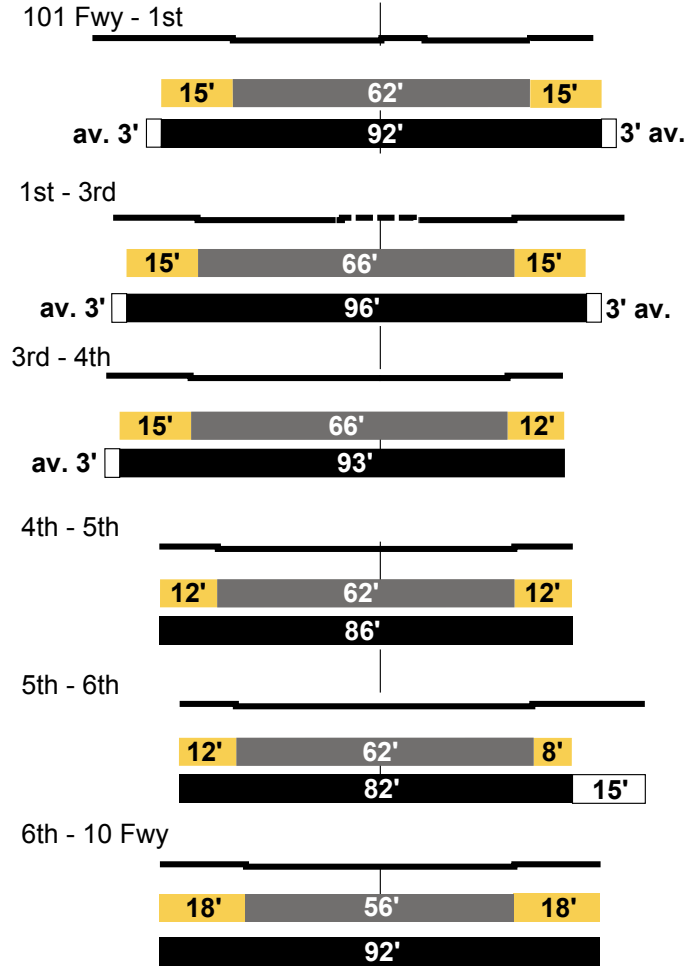

BROADWAY
 Avenue II north of Temple St
 Modified Avenue II south of Temple St
 Looking north

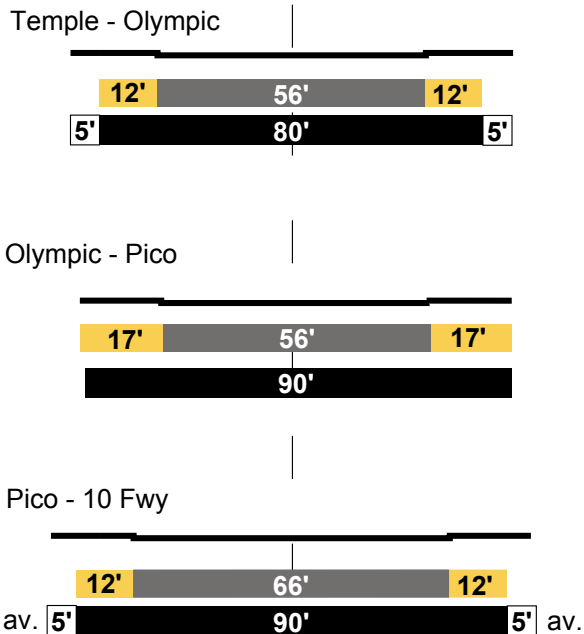

OLIVE STREET Modified Avenue II
 Looking north 2-way 1st -4th; 1-Way 4th - Venice

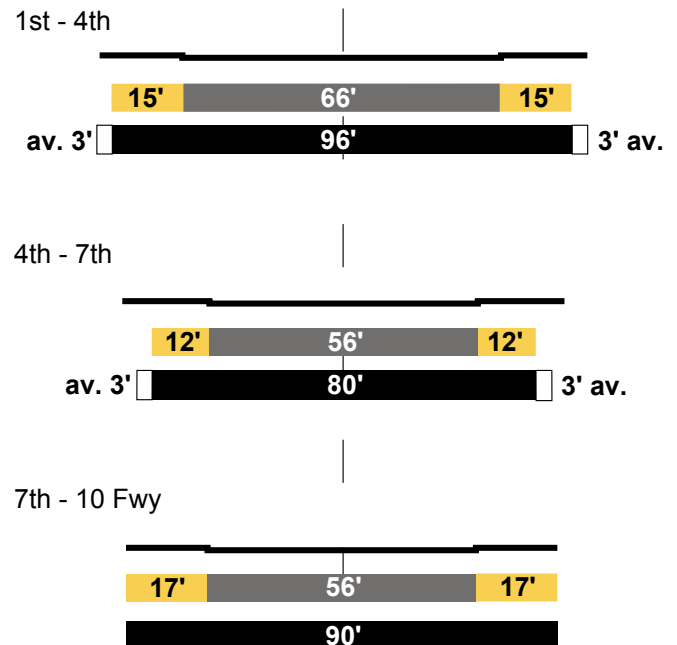

GRAND AVENUE

Modified Avenue II north of Temple St
 Modified Boulevard II from Temple St - 4TH St
 Modified Avenue II south of 4TH St
 Looking North 2 way 1st -5th; 1-Way 5th - Venice

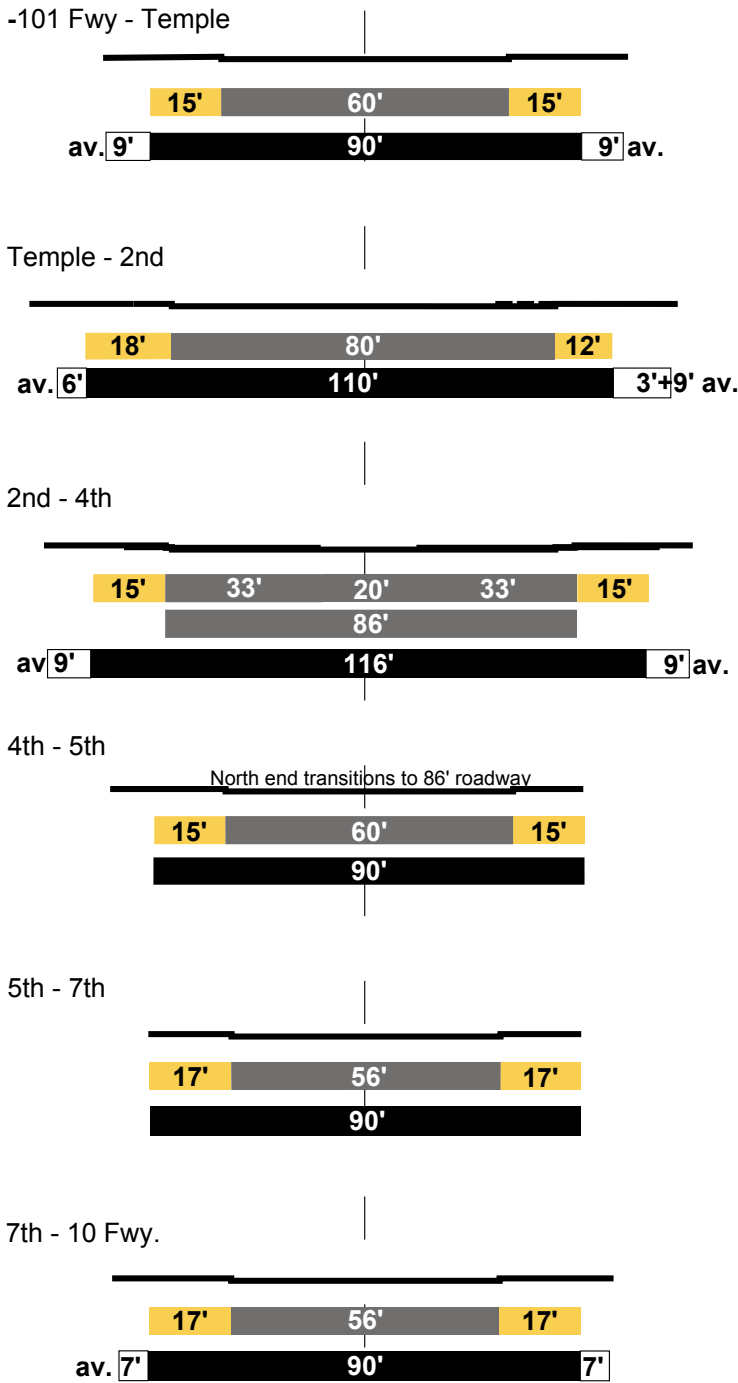

HOPE STREET

Modified Avenue II north of 1ST St; 6TH St to Olympic Blvd
 Modified Avenue I from 1ST St to 5TH St
 Avenue II south of Olympic Blvd
 Modified Avenue III from 5TH ST to 6TH ST
 Looking north Temple - 1st

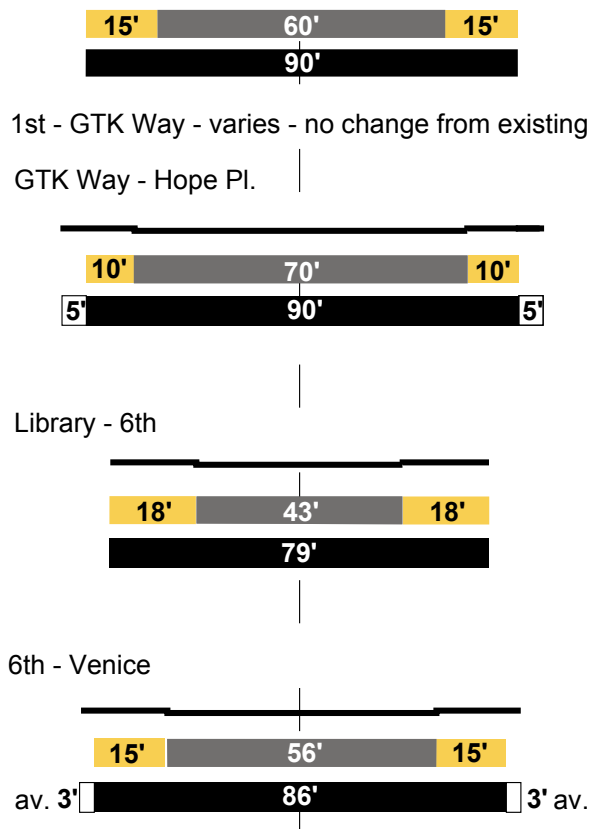

FLOWER STREET

Avenue II from 1ST St to 3RD St
 Avenue I from 3RD St to 6TH St
 Modified Avenue II from 6TH St to 11TH St
 Modified Avenue I south of 11TH St
 Looking north

3rd - 6th

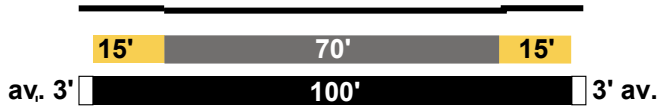

6th - 7th

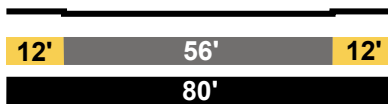

7th - 11th

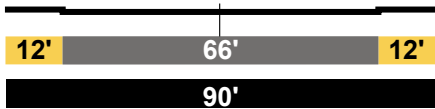

11th-10 Fwy

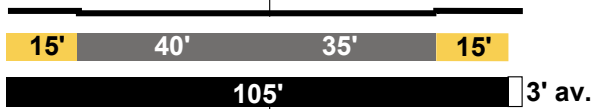

FIGUEROA STREET

Boulevard II north of Wilshire
 Avenue I from Wilshire to Olympic Blvd
 Modified Boulevard II south of Olympic Blvd
 Looking north

2-Way north of 3rd
 2-Way south of Olympic
 1-Way 3rd-Olympic

101 Fwy. - Olympic except Wilshire - 7th & at the Pantry
 (see below):

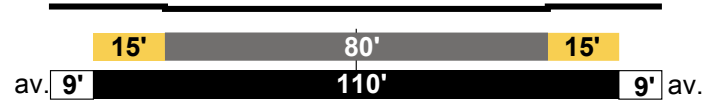

Wilshire - 7th:

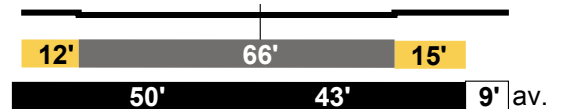

9th - Olympic at the Pantry:

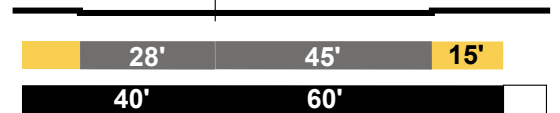

Olympic - 10 Fwy.

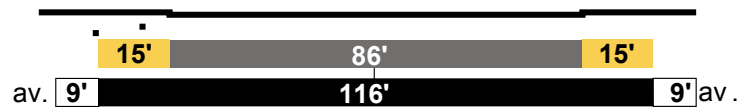

DOWNTOWN STREET DESIGNATIONS: EAST - WEST STREETS

TEMPLE STREET

Avenue II west of Broadway
Modified Avenue II east of Broadway

Figueroa - Broadway

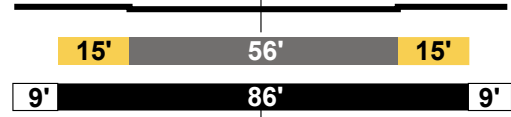

Broadway - San Pedro

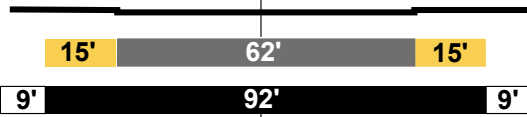

San Pedro - Alameda

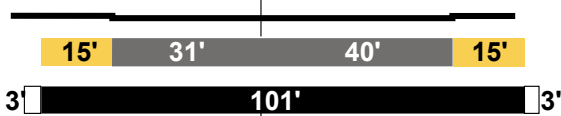

Figueroa - Hill

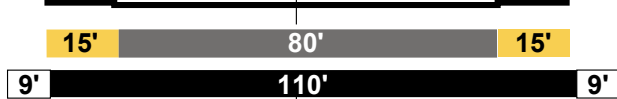

Hill - Main

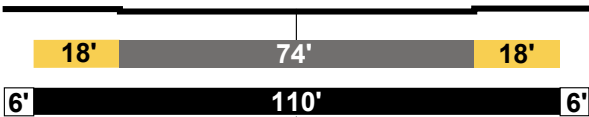

Main - San Pedro

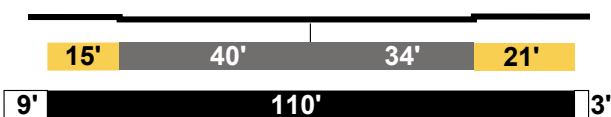

San Pedro - Central

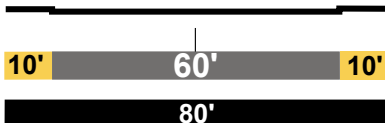

Central - Alameda

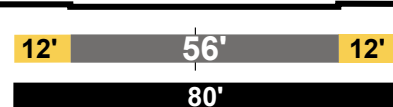

2ND STREET

Modified Avenue III from Figueroa to Judge John Aliso
Modified Collector Streets from Judge John Aliso to Alameda St

Looking west

Tunnel between Figueroa & Olive

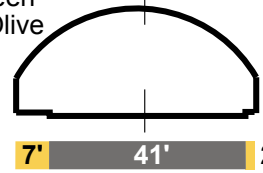

East end of tunnel - Hill

To/from tunnel

Upper 2nd St.

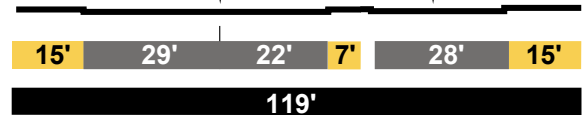

Hill - Los Angeles

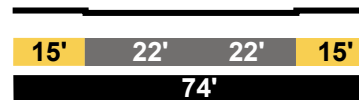

Los Angeles - San Pedro

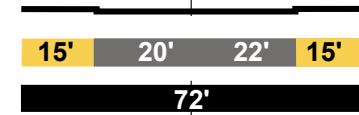

San Pedro - Alameda

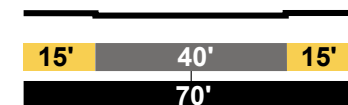

3RD STREET

Modified Boulevard II from Figueroa St to Flower St
 Modified Avenue II from Flower St to Hope St
 Modified Avenue III Hope St to Los Angeles St
 Avenue II from Los Angeles St to Alameda St
 Looking west

Figueroa - Flower

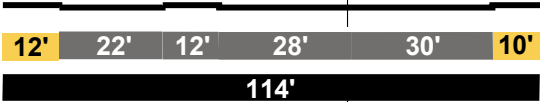

Flower - tunnel

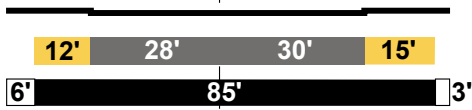

tunnel

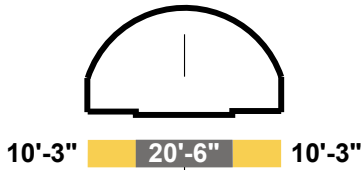

tunnel - Hill

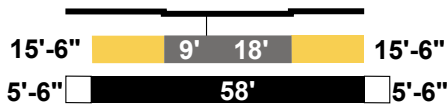

Hill - Spring

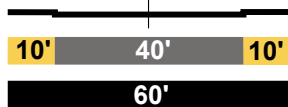

Spring - Los Angeles

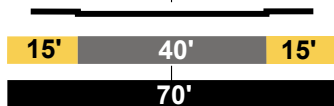

Los Angeles - Alameda

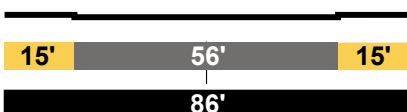

4TH STREET

Modified Boulevard II from Hope St to Grand Ave
 Modified Avenue I from Figueroa St to Hope St;
 Grand Ave to Olive St
 Modified Avenue II from Olive St to Hill St
 Modified Avenue III from Hill St to Los Angeles St
 Avenue III from Los Angeles St to Judge John Aliso
 Avenue II from Judge John Aliso to Alameda
 Looking west

Grand - Olive

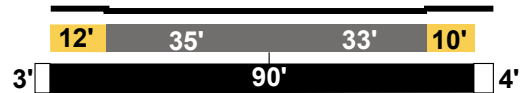

Olive - Hill

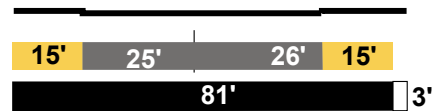

Hill - Main

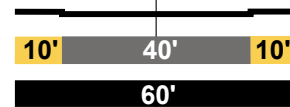

Main - Los Angeles

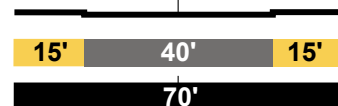

Los Angeles - Central

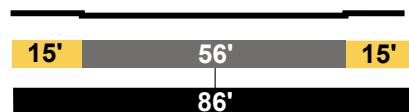

5TH STREET

Modified Avenue I west of Figueroa St
 Avenue I from Figueroa St to Flower St
 Modified Avenue II from Flower St to Hill St
 Modified Avenue III from Hill St to Los Angeles St
 Avenue II from Los Angeles St to Central Ave
 Looking west

110 Fwy - Figueroa

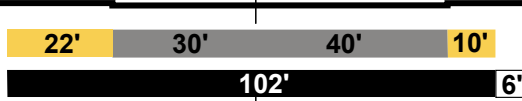

Figueroa - Flower

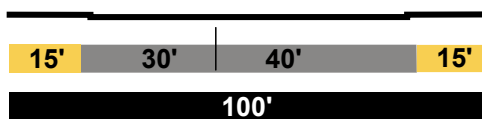

Flower - Grand

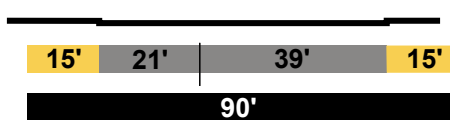

Grand - Olive

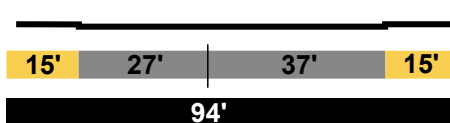

Olive - midblock Olive/Hill

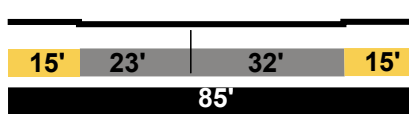

midblock Olive/Hill - Hill

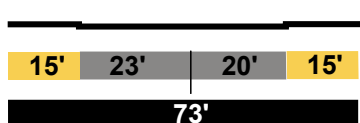

Hill - Main

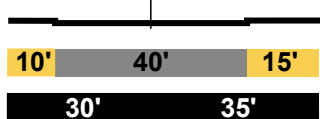

Main - Los Angeles

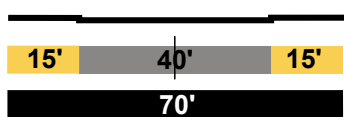

Los Angeles - San Pedro

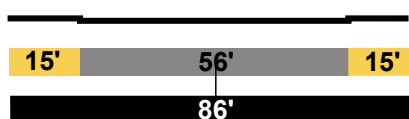

6TH STREET

Modified Avenue I 110 FWY to Flower St
 Modified Avenue III Flower St to Los Angeles St
 Avenue II east of Los Angeles St
 Looking west

110 Fwy - Flower

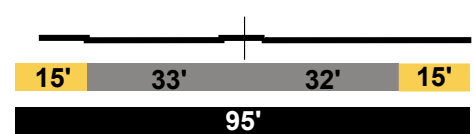

Flower - Olive

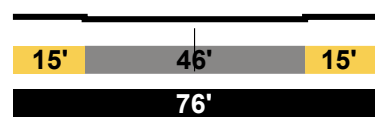

Olive - Hill

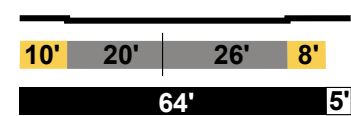

Hill - alley bet. Hill/Broadway

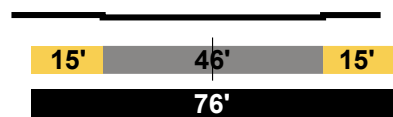

alley bet. Hill/Broadway - Main

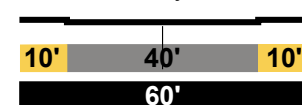

Main - Los Angeles

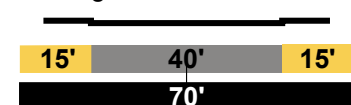

Los Angeles - San Pedro

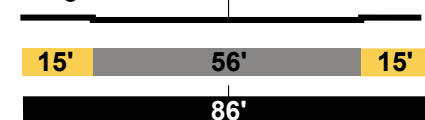

WILSHIRE BOULEVARD

Modified Avenue I east of Figueroa
Modified Avenue II from Figueroa to Flower St
Avenue II from Flower St to Grand Ave
 Looking west

110 Fwy - Figueroa

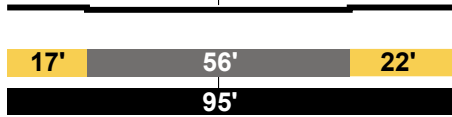

Figueroa - Flower

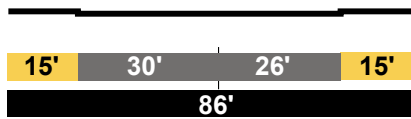
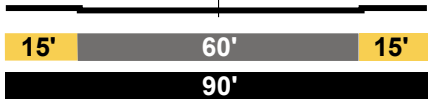

Flower - Hope

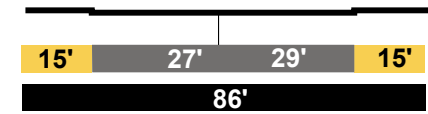
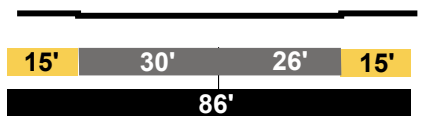

Hope - Grand

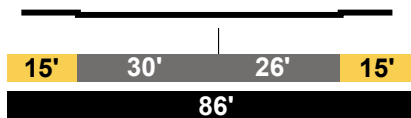
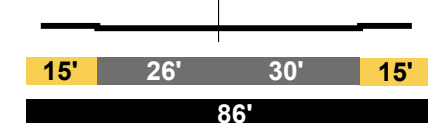

7TH STREET

Modified Avenue II west of Los Angeles St
Avenue II east of Los Angeles St
 Looking west

110 Fwy - Figueroa

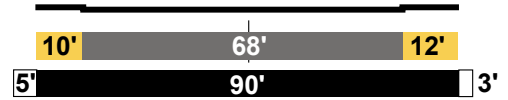

Figueroa - 100' east of Los Angeles

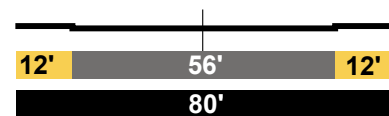

100' east of Los Angeles - San Pedro

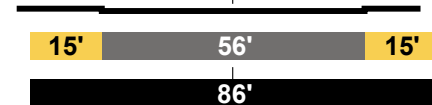

8TH STREET
Modified Avenue II east of Olive St
Modified Avenue III from Olive St to Main St
Avenue II east of Main St
 Looking west

110 Fwy - Figueroa

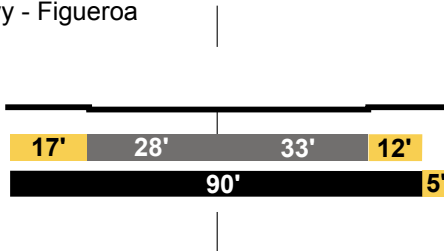

Figueroa - Olive

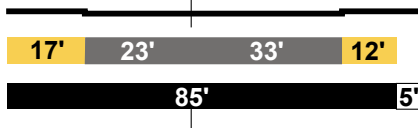

Olive - Hill

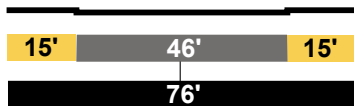

Hill - Broadway

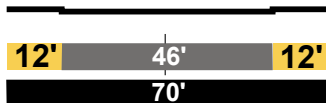

Broadway - Main

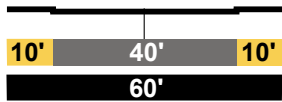

Main - San Pedro

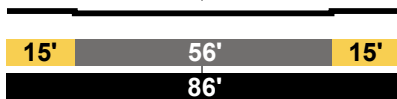

JAMES M. WOOD/ 9TH STREET
Modified Avenue II from 110 FWY to Olive St
Modified Avenue III from Olive St to Spring St
Avenue II from Main St to Judge John Aliso
Avenue I east of Judge John Aliso
 Looking west

110 Fwy - Figueroa

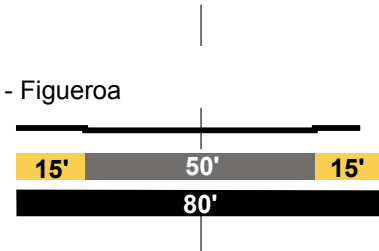

Figueroa - Olive

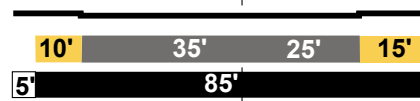

Olive - Hill

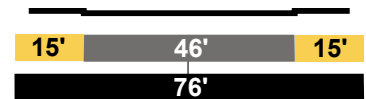

Hill - Main

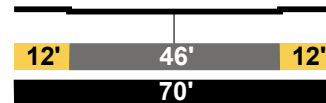

Main - San Pedro

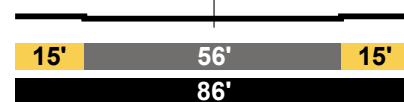

OLYMPIC BLVD.
 Boulevard II east of Flower St; Broadway to Maple Ave
 Modified Boulevard II from Flower St to Hope St
 Modified Avenue I from Hope St to Broadway
 Modified Avenue III from Maple Ave to San Julian St
 Looking west

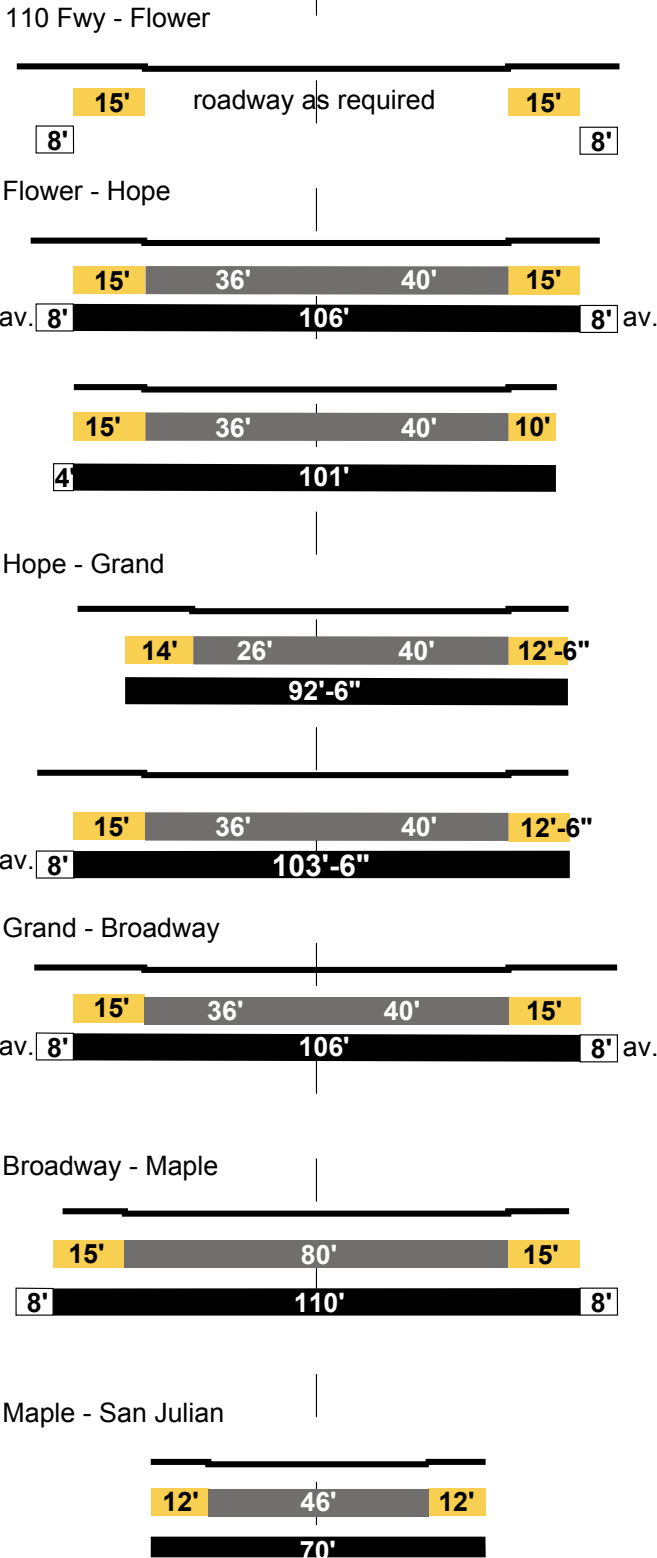

**CHICK HERN COURT/
 11TH STREET**
 Modified Collector Street- 2-way west of Figueroa
 Looking west 1-way east of Figueroa

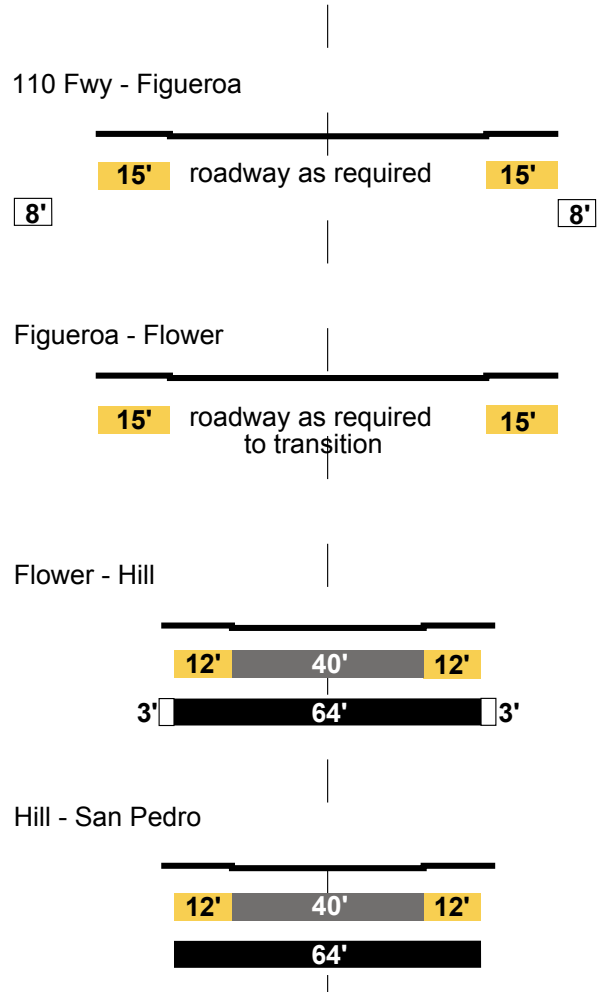

12TH STREET

1-way west of Wall 2-way east of Wall
Avenue II from Figueroa to Flower St
Modified Collector Street east of Flower St

Looking west

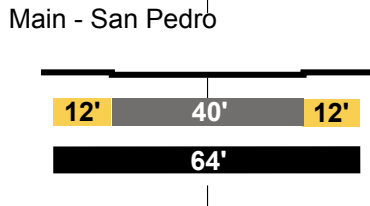
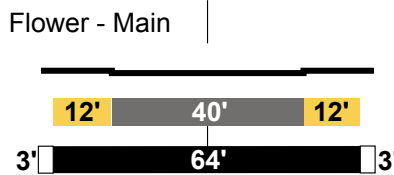
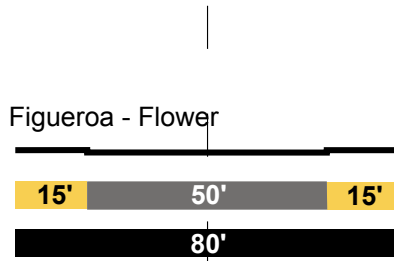

PICO BOULEVARD

Modified Avenue II from 110 FWY to Figueroa
Modified Boulevard II from Figueroa to Flower St
Avenue I from Flower St to Broadway
Modified Avenue III from Broadway St to Main St
Modified Local Street - Standard from Main St to San Pedro St
Local Street - Standard from San Pedro St to Stanford Ave
Collector Street from Stanford Ave to Central Ave

Looking west

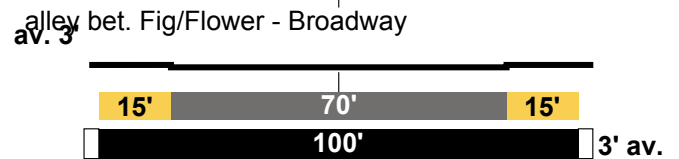
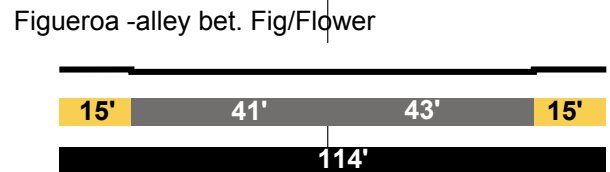
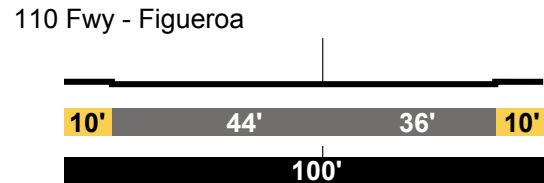

Broadway - Main
As required to transition.

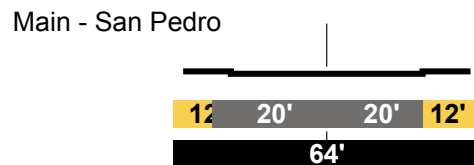

14TH STREET
Modified Local Street - Standard
from Grand Ave to Maple St

Looking west

Grand - Maple

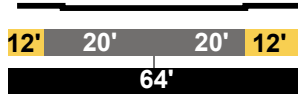

VENICE BOULEVARD / 16TH STREET
Modified Avenue II from 110 FWY to San Pedro
Avenue II from San Pedro to Hooper Ave
Local Street - Standard east of Hooper Ave
 Looking west

110 Fwy - Figueroa at the intersection w/Figueroa

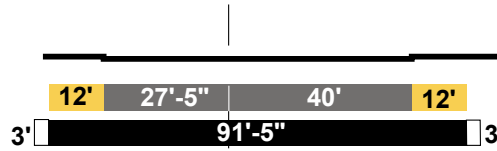

15TH STREET Modified 2-Way Collector

Looking west

Grand - Maple

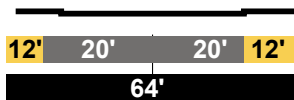

Figueroa - Hope except alley bet. Flower & Hope - Hope

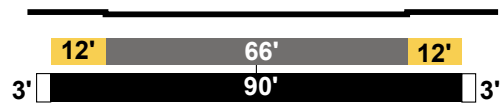

alley bet. Flower & Hope - Hope (at Venice Hope Park)

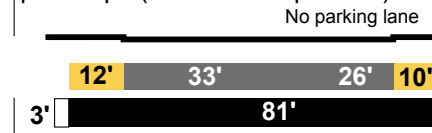

Hope - Grand

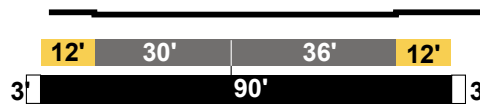

Grand - San Pedro

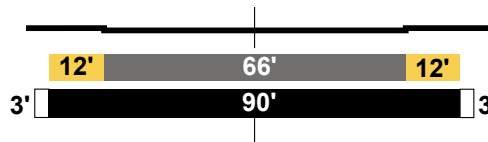

PA T B DETAILED RECOMMENDATIONS

Ad Hoc Downtown Street Standards Committee

BACKGROUND

The Ad Hoc Downtown Streets Standards Committee was convened in response to a series of Council Motions (CF-05-1514 and CF-06-0547) which address the need and desire to revise the Downtown Street Standards. The Ad Hoc Street Standards Committee initially met on July 13, 2006 and, in the ensuing months, developed the street cross sections found in this document's detailed recommendations section. The following agencies are included in the Downtown Ad Hoc Street Standards Committee: the Departments of Transportation, City Planning and PublicWorks; the Community Redevelopment Agency of Los Angeles (CRA/LA); the Los Angeles Metropolitan Transportation Authority (Metro) and staff of Council Districts 9 and 14.

PURPOSE

The Downtown Street Standards are a companion to the Downtown Community Plan street designations, providing a comprehensive street hierarchy that balances traffic flow with other equally important functions of the street, including: pedestrian needs, public transit routes and stops, bicycle routes, historic districts with fixed building street walls, the public face and transitional "front yard" of businesses, pedestrian environments and linear open space considerations.

The new Downtown Street Standards establish definitive future curb lines and property lines for all Downtown streets, and, in some locations, additional required average sidewalk easements. The Downtown Street Standards also provide certainty for developers and their architects as to the building street wall location and required roadway improvements. They also provide certainty for building, business and homeowners that the character of their street on which their investments are located will not be diminished by unanticipated future sidewalk narrowing.

The Downtown Street Standards consist of a series of street cross sections which are specific to each street or street segment, including one-way pair standards, rather than a single cross section for all street designations.

NEXT STEPS

The Downtown Design Guide is rescinded with the adoption of the Downtown Community Plan. Portions of the Downtown Design Guide relevant to applying the Downtown Street Standards have been incorporated in Appendix E of the Downtown Community Plan Implementation Overlay: Public Realm Best Practices.

ASSUMPTIONS

Lane Capacity. Lane capacity assumptions for planning purposes are as follows:

850/lane	one-way
750/lane	two-way with continuous center turn lane or left turns/median & parking
700/lane	two-way with left turns at intersections (from parking) & parking

Buses. All streets need to be bus ready, that is, with adequate sidewalk width for pedestrians, typically 15 feet minimum and more where there are higher concentrations of pedestrians.

Bicycles. Bicyclists may legally ride on all streets (CVC 21200) whether there is dedicated bicycle infrastructure or not. These "detailed recommendations" reflect the initial work of the Ad Hoc Downtown Street Standards Committee to identify street segments that should accommodate bicycle infrastructure, and may not necessarily be consistent with the more recently adopted policies and designations found in the City's Mobility Plan 2035, which supersedes this document.

CRITERIA

Note: these are general rules and there are always exceptions to general rules.

1. Consistent roadway width / striping by street segment (typically by district), i.e., Civic Center / Bunker Hill / Historic Core-Financial District (south of 1st except Bunker Hill) / South Park (south of Olympic), unless there is an overriding need, e.g, Figueroa St. to provide freeway access.
2. Striping to preserve on-street parking with left turns at the intersections, except where continuous turn lane is needed due to significant mid-block turn movements.
3. Accept slower speed (35 mph or less) lane widths as appropriate for most Downtown streets.

	<u>35 mph or less</u>	<u>More than 35 mph</u>	<u>Existing Minimums</u>
Curb Lanes	11'	12'	10'
Traffic Lanes	10'	11'	9-10'

5. Sidewalk widths vary based on street width and traffic adjacency as well as land use. Minimum sidewalks from ROW should be as follows.

	<u>Secondary</u>	<u>Major</u>	<u>Existing Mins.</u>
Curbside parking 24/7:			
Curb extensions			
(Corner & midblock)	12'	15'	NA
No curb extensions	15'	18'	10'
Curbside traffic lane	17'	20'	10'*

* Too narrow if buses in curb lane.

5. Standards works both ways, e.g., if new street standard is one-way secondary and roadway is currently wider than the standard, roadway narrowing should be triggered by the same actions that trigger roadway widenings, e.g., discretionary approvals, or roadway should be narrowed by a capital improvement project.
6. Curb extensions at all mid-block crossing where there are parking-only curb lanes.

7. Curb extensions at all corners on streets with parking-only curb lanes where: 1) no turn is permitted, e.g., against flow on one-way streets or 2) turn volumes are low.
8. Curb radii – There is no standard curb radius to apply in Downtown. Curb radii should be determined in detailed design per the provisions of the City of Los Angeles Supplemental Street Design Guide (May 2020). Smaller corner radii can improve pedestrian safety by shortening crossing distances (reducing exposure), increasing pedestrian visibility, and decreasing vehicle turning speed. Smaller corner radii also provide better geometry for installing directional curb ramps at each corner, resulting in a straight direction of travel for pedestrians. Smaller curb radii are especially beneficial at intersections with pedestrian and bicyclist activity and intersections where crashes result from motorist failure to yield due to higher right turning speeds.
9. Maximize curb-side parking – convert red curb to parking where appropriate.
10. Allow peak-period curbside parking where curb lane is at least 18' wide.
11. Bus stop curb extensions on far-side, transit-priority streets with parking-only curb lanes.
12. No bus pull-outs.
13. Preserve adequate lot depths to accommodate quality development – in some locations dedications have resulted in parcels that are too shallow to accommodate well-designed development projects.

RECOMMENDED STANDARDS AS ILLUSTRATED BY CROSS SECTIONS

The recommended Downtown Street Standards are modifications of the existing street designations and apply to the Downtown street segments illustrated in the attached cross sections.

The primary distinction among the primary types of street designations that occur Downtown is in number of traffic lanes:

Boulevard	4 full-time traffic lanes (2 in each direction for a two-way street; 4 in one direction for a one-way street) and 2 additional peak-period traffic lanes that displace off-peak parking.
Avenue	4 full-time traffic lanes (2 in each direction for a two-way street; 4 in one direction for a one-way street) and full-time parking lanes.
Collector and Local	2 full-time traffic lanes (1 in each direction for a two-way street; 2 in one direction for a one-way street) and full-time parking lanes.

The Downtown Street Standards are illustrated by a series of cross sections. The cross sections show the typical midblock conditions. Intersections are not shown. This version of the cross sections shows lane striping, so that the traffic impacts of the recommended street standards can be evaluated. The Downtown Street Standards that are ultimately adopted will not show lane striping, since lane striping is not a part of the Street Standards. However, the striping shown represents the Ad Hoc Committee's recommendation to LADOT with respect to the provision of full-time and non-peak hour parking.

For each street, the existing street designation and existing cross sections by segment are shown in the left column. The proposed cross sections for those same segments are shown in the right column. The legend on the following page identifies each element in the cross section diagrams.

The proposed Downtown Street Standard for each street segment includes:

- Width of right-of-way (ROW).
- Width of roadway (curb to curb),
- Width of sidewalk within ROW, The sidewalk width cannot be reduced, that is, the roadway cannot be widened at the expense of the sidewalk.
- Average width of sidewalk easement. In addition to the sidewalk in the ROW, on most street segments an additional sidewalk easement is required. This easement is to be treated as an extension of the sidewalk in the ROW. To provide flexibility in building design and at the same time provide space for sidewalk activity, the required sidewalk easement may be averaged. The easement provided on any section of the project frontage may range from zero feet to 3 times the required easement width, provided that the total area of the easement divided by the length of the property frontage equals the required average. The area of an easement beyond 3 times the required easement width may not be counted towards the required square footage of the average easement area.

These standards will be accompanied by recommended sidewalk improvements, found in Appendix E of the Downtown Community Plan Implementation Overlay: Public Realm Best Practices, including:

- Pedestrian-scale street lights.
- Continuous landscaped parkway.
- Large tree well (minimum 100 square feet).
- Small tree well (40 to 100 square feet) with structural soil under entire sidewalk.
- Tree planting in parkway or large tree well
- Tree planting in small tree.
- Irrigation of parkways and tree wells.

Appendix E specifies locations or conditions in which small tree wells with structural soil may be appropriate. In all other locations continuous landscaped parkways or large trees are required and are to be designed to collect stormwater runoff from the paved walkway.

Property owners are required to maintain all improvements on the adjacent sidewalk and sidewalk easement and may be required to maintain medians and other improvements in the public ROW as a condition of project approval.

CROSS SECTION LEGEND

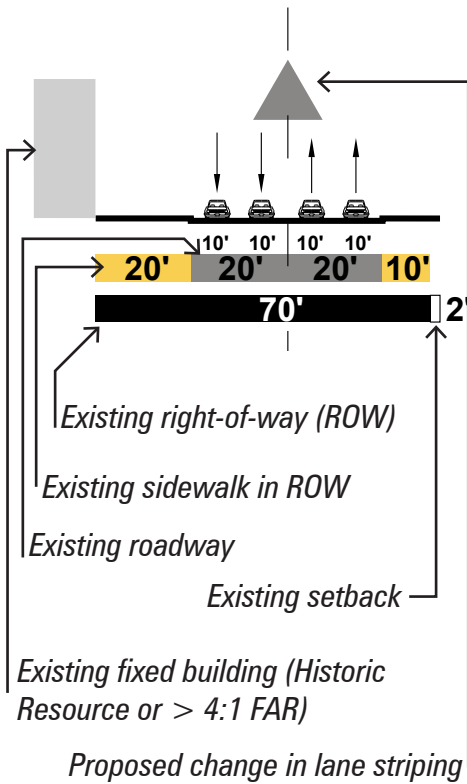
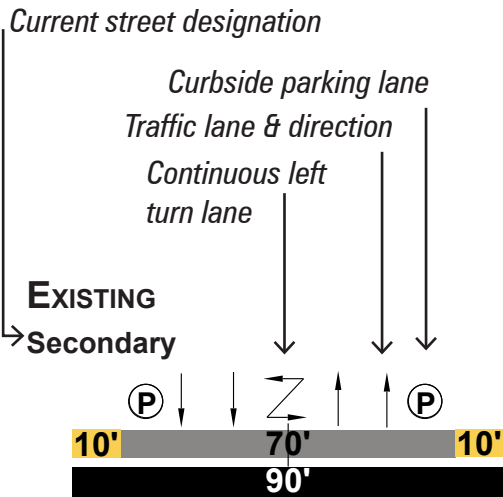

PROPOSED
Modified Secondary - Two Way

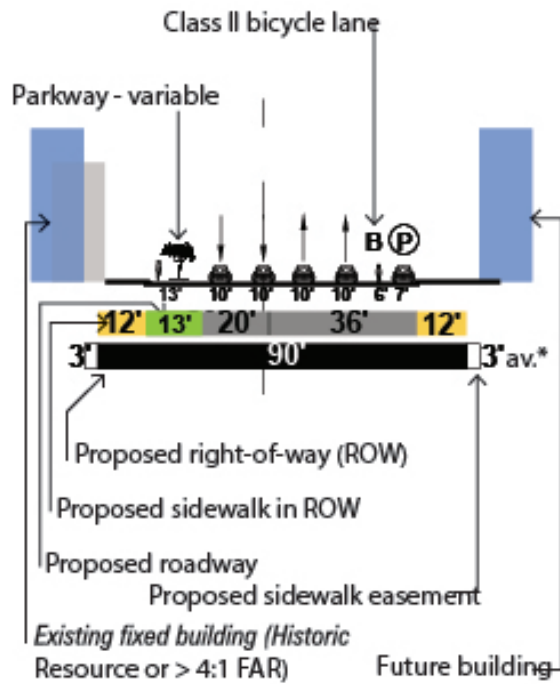

* av. = average; easement may range from 0' to 3 times the average, provided that the total area of the easement divided by the linear frontage of the property equals the required average easement.

NORTH - SOUTH STREETS

LOS ANGELES STREET looking north EXISTING

Secondary

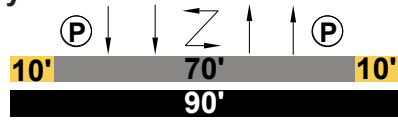

Temple - 2nd

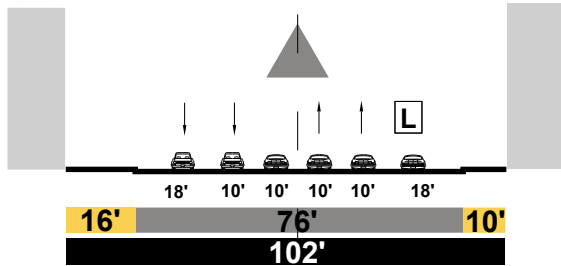

2nd - Winston

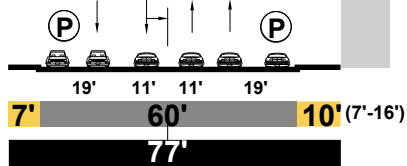

Winston - Olympic

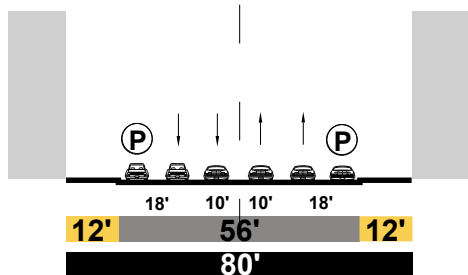

Olympic - 10 Fwy

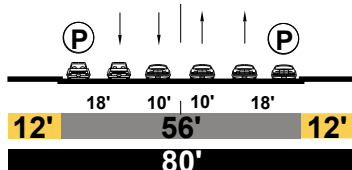

PROPOSED

Modified Avenue I from Temple St - 2ND St
Modified Avenue II from 2ND ST - Winston St
Avenue II south of Winston St

Temple - 2nd

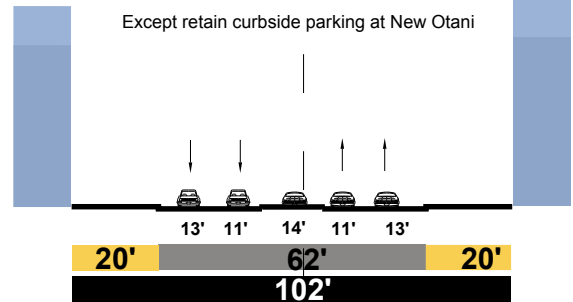

2nd - Winston

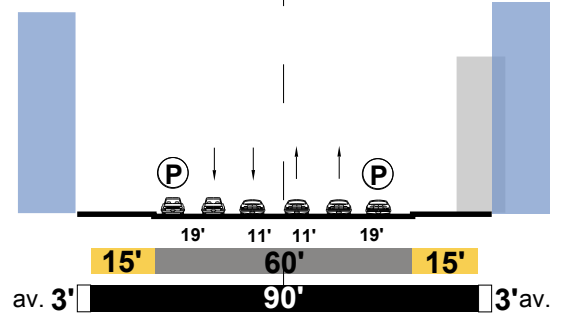

Winston - 10 Fwy.

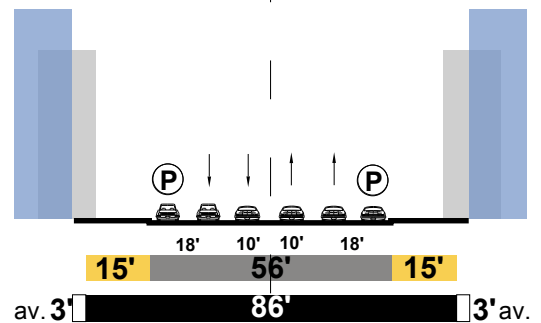

MAIN STREET NORTH OF 9TH STREET looking north

EXISTING

Secondary

PROPOSED

**Modified Avenue I from Temple St - 1ST St
Avenue II south from 1ST St to 9TH St**

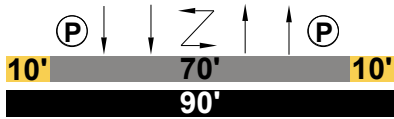

Temple - 1st

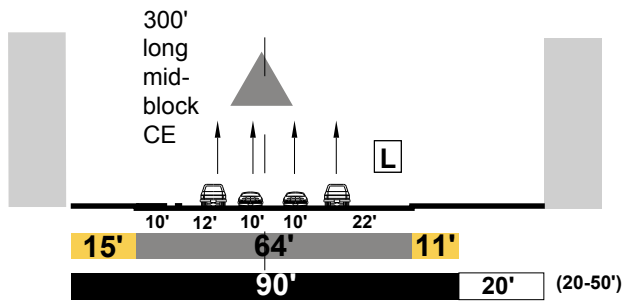

Temple - 1st

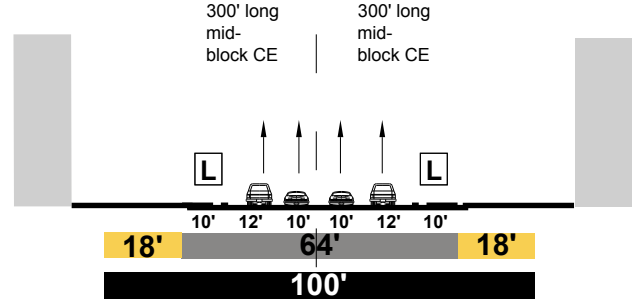

1st - 5th

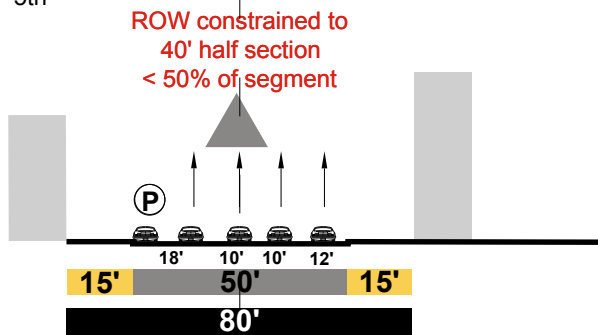

1st - 3rd

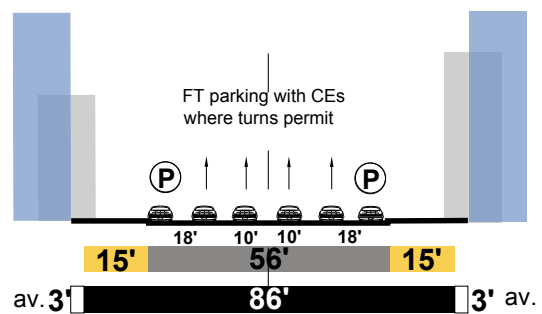

3rd - 5th

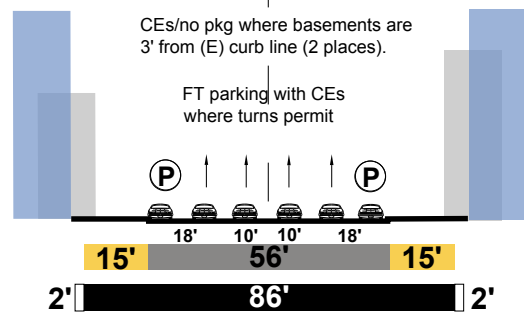

5th - 9th

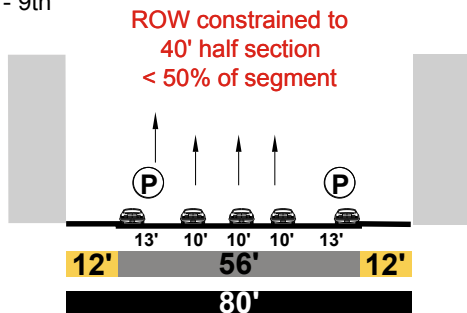

5th - 9th

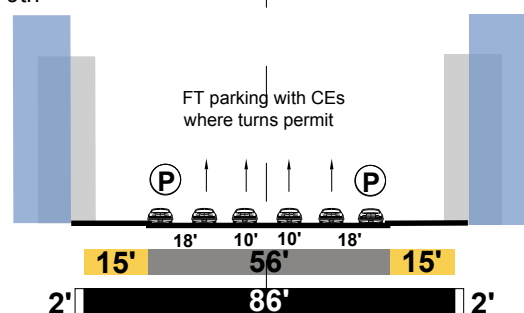

MAIN STREET SOUTH OF 9TH STREET looking north
EXISTING

Secondary 9th - Olympic
 Major Class II Olympic - Venice

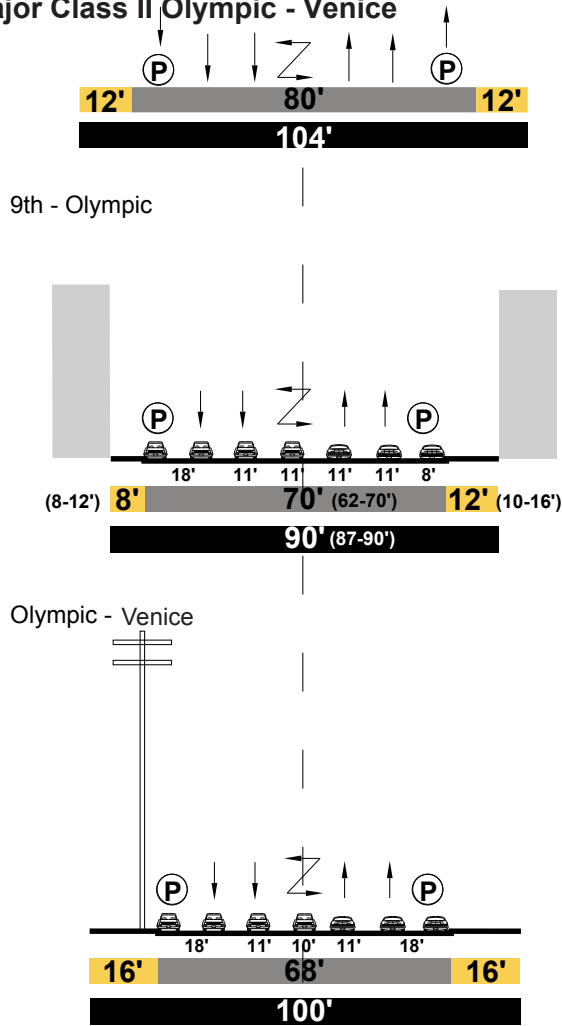

PROPOSED
Modified Avenue I from south of 9TH St

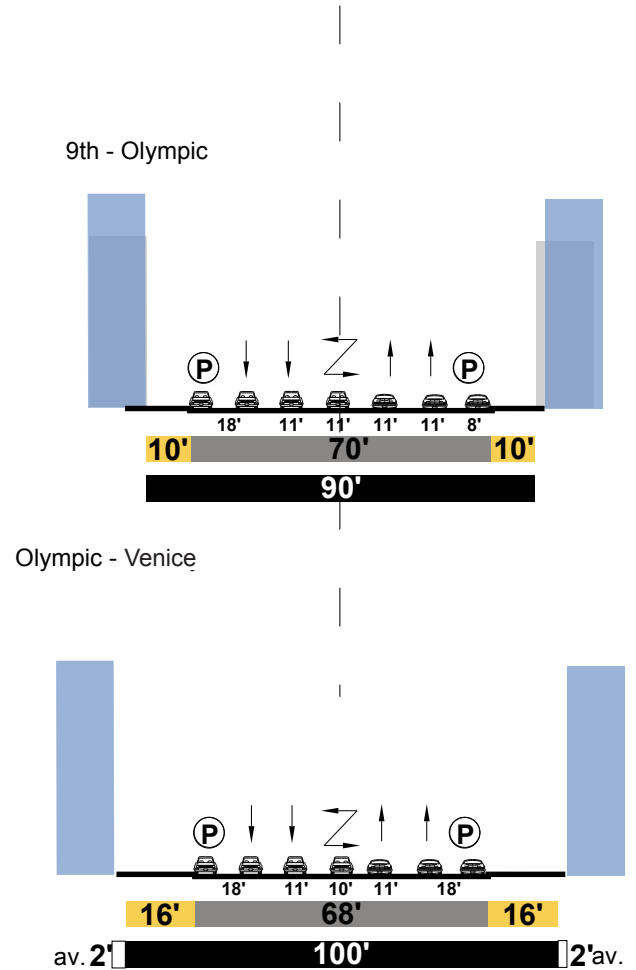

SPRING STREET looking north
EXISTING
 Secondary I

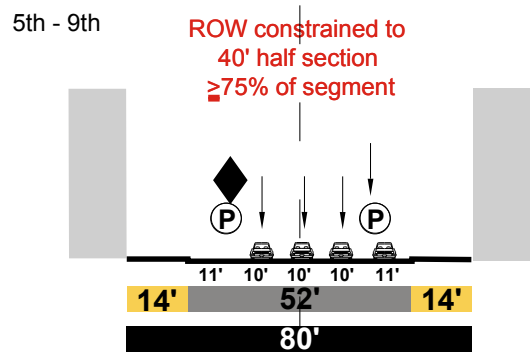
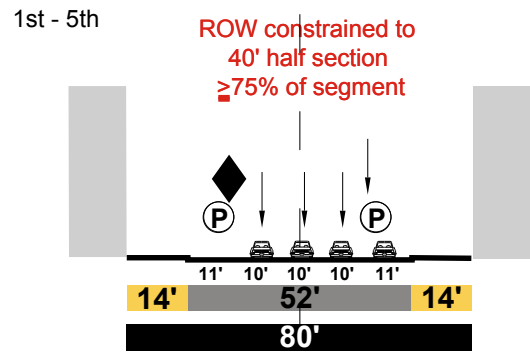
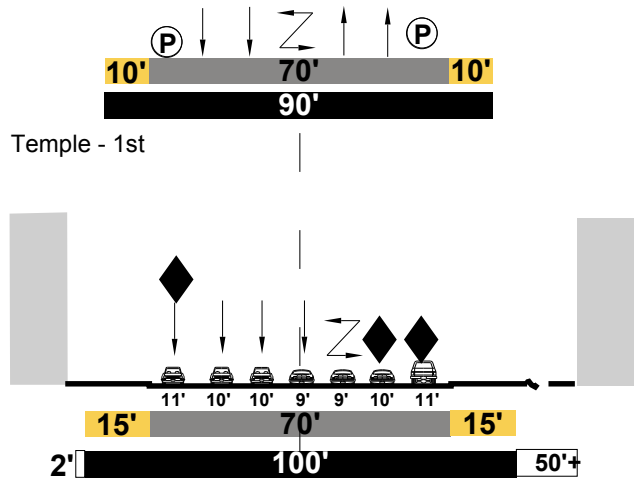

PROPOSED
 Avenue I north of 1ST St
 Modified Avenue II from 1ST St to 9TH St

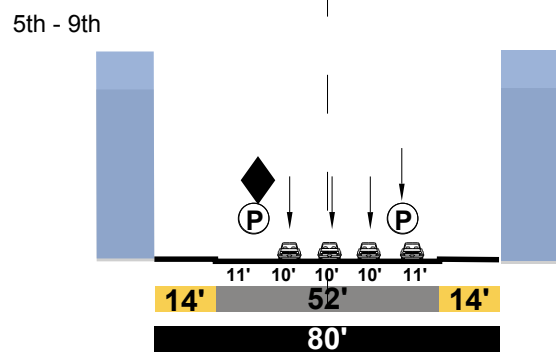
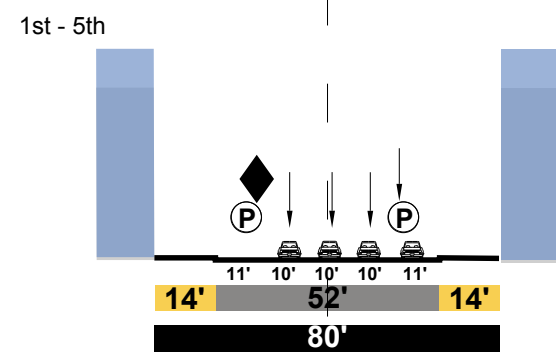
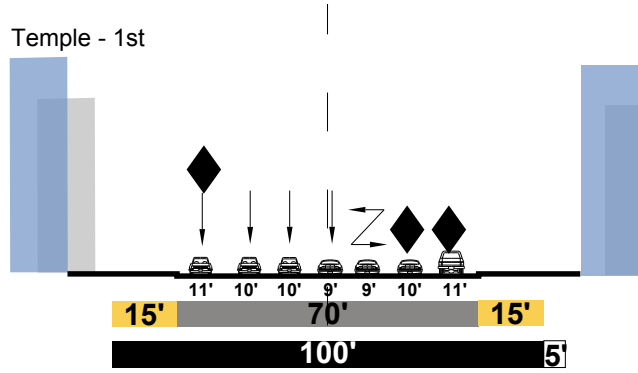

BROADWAY looking north
EXISTING
Secondary

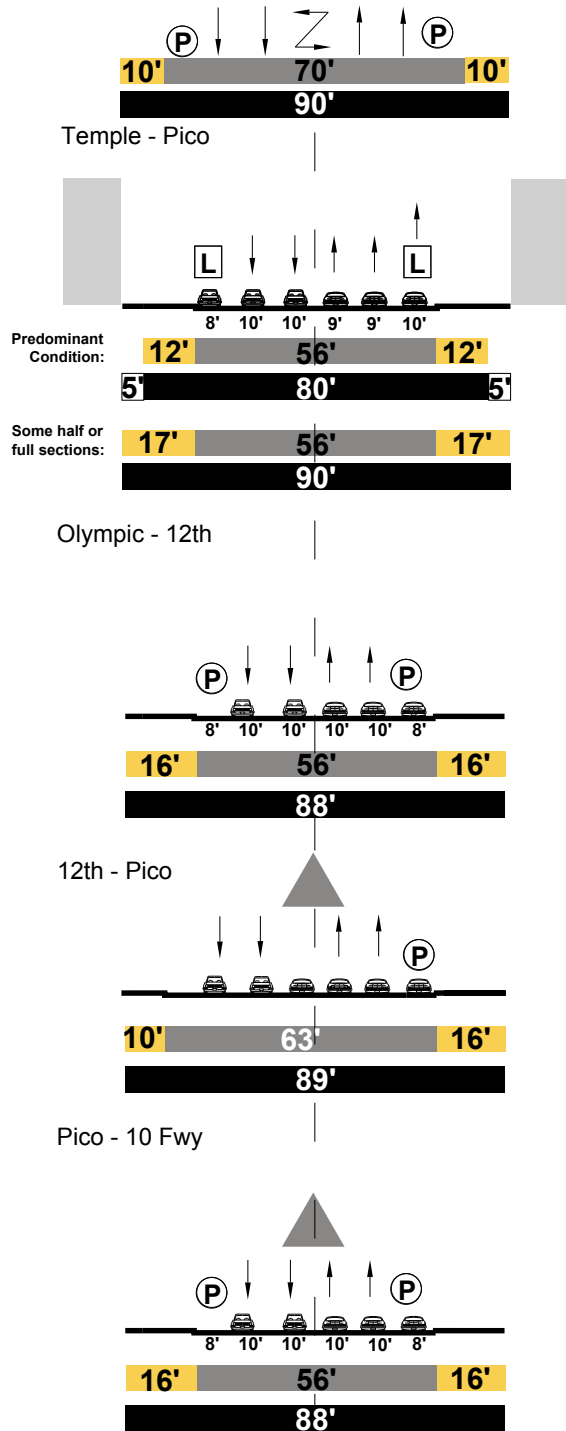

PROPOSED
Avenue II north of Temple St
Modified Avenue II south of Temple St

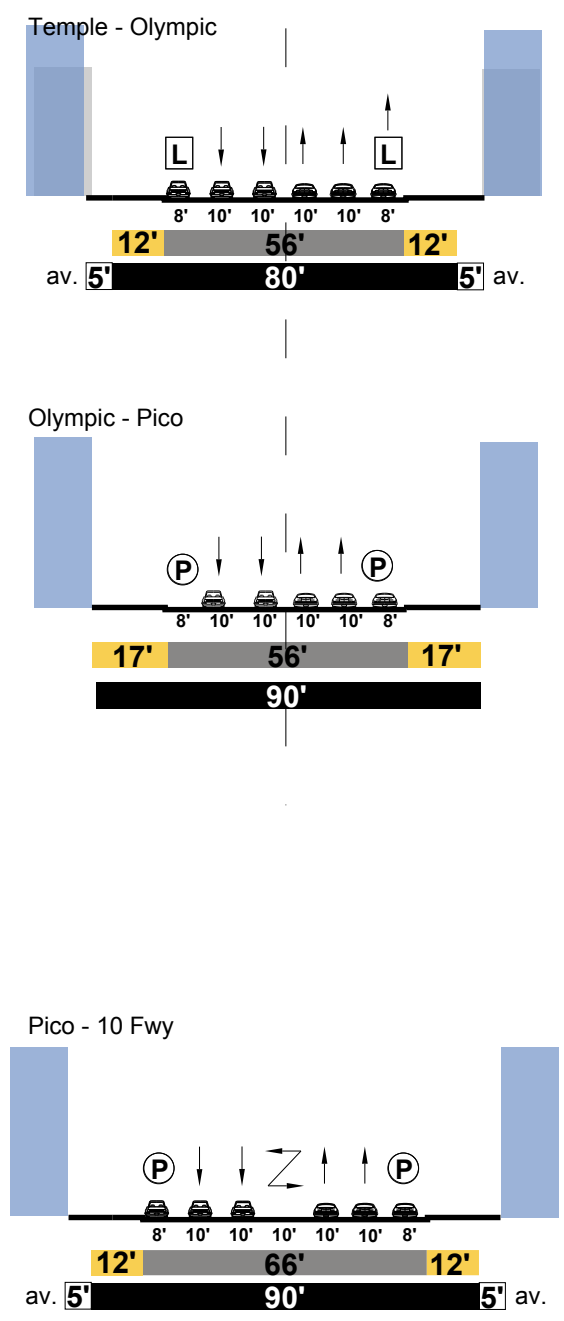

HILL STREET looking north

EXISTING

Secondary I

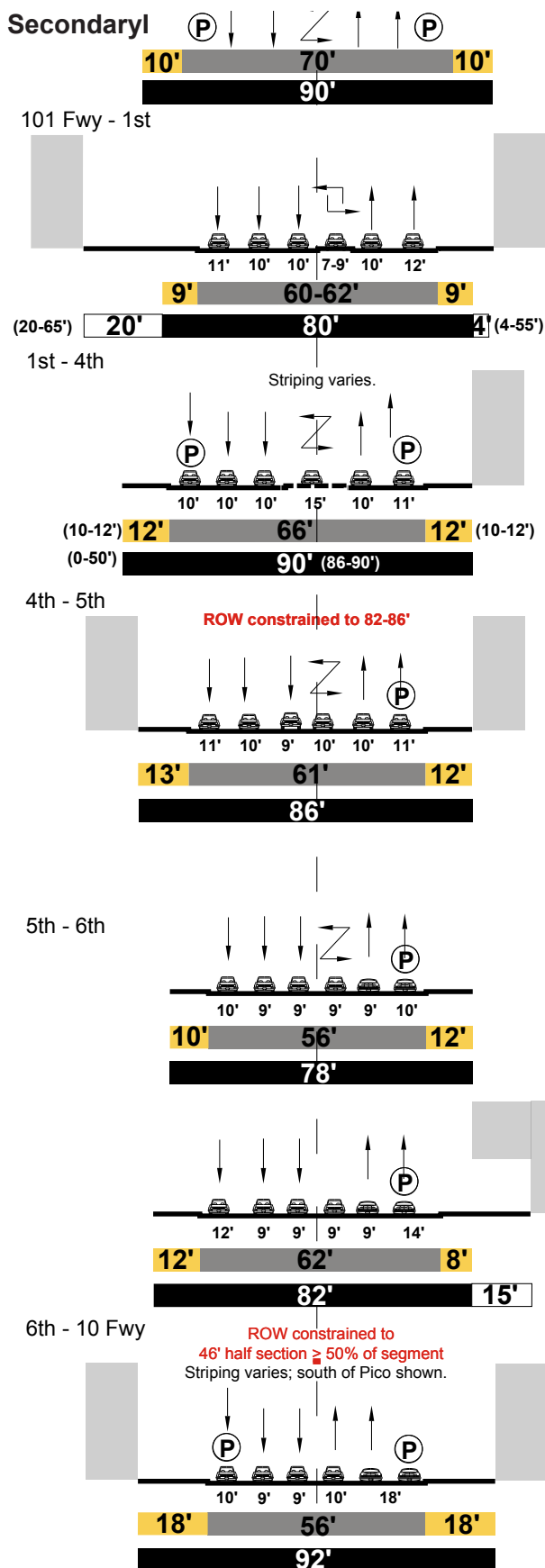

PROPOSED

Modified Avenue II

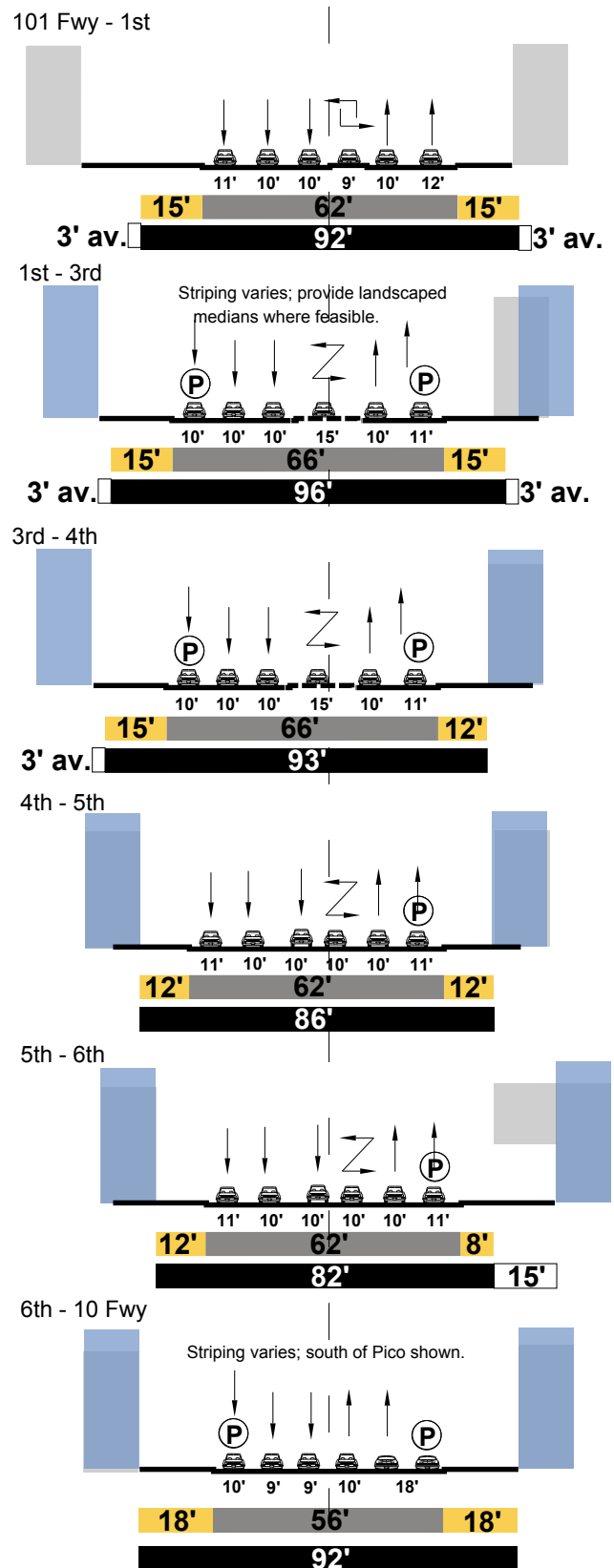

OLIVE STREET looking north

EXISTING Secondary

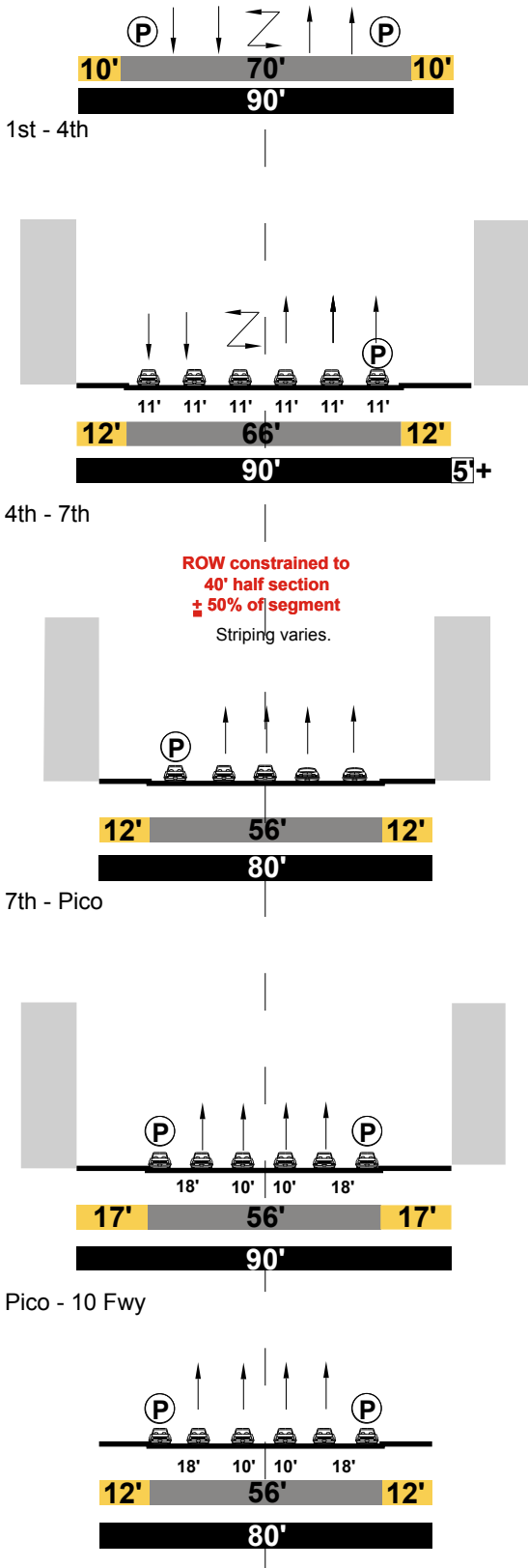

PROPOSED Modified Avenue II

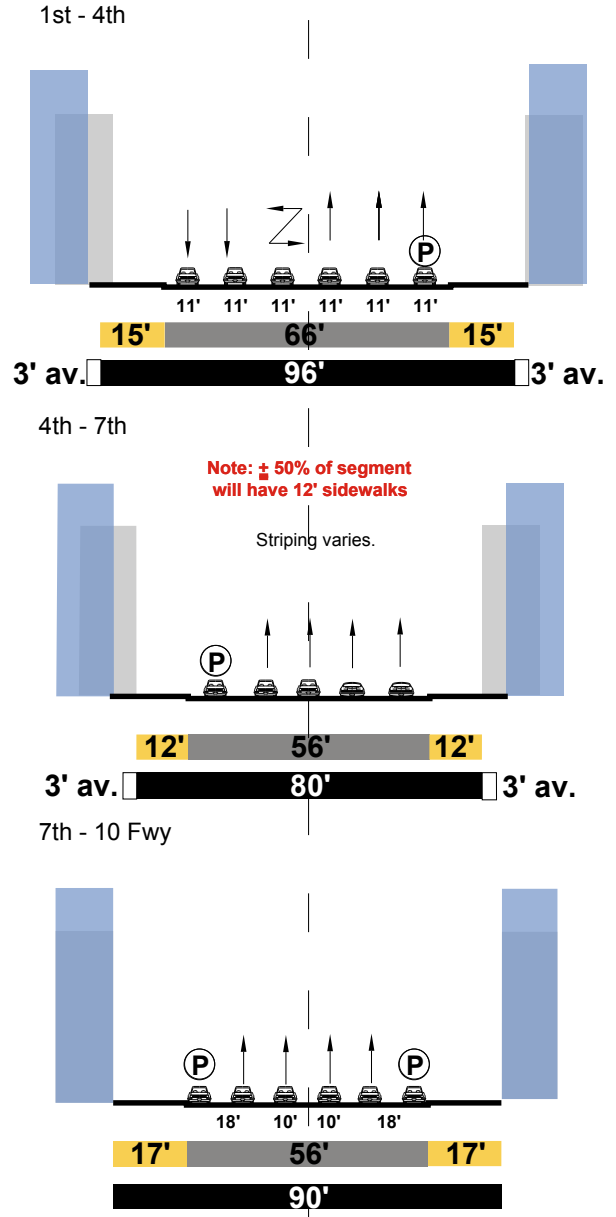

GRAND AVENUE looking north
EXISTING
 Major Class II

PROPOSED
 Modified Avenue II north of Temple St
 Modified Boulevard II from Temple St - 4TH St
 Modified Avenue II south of 4TH St

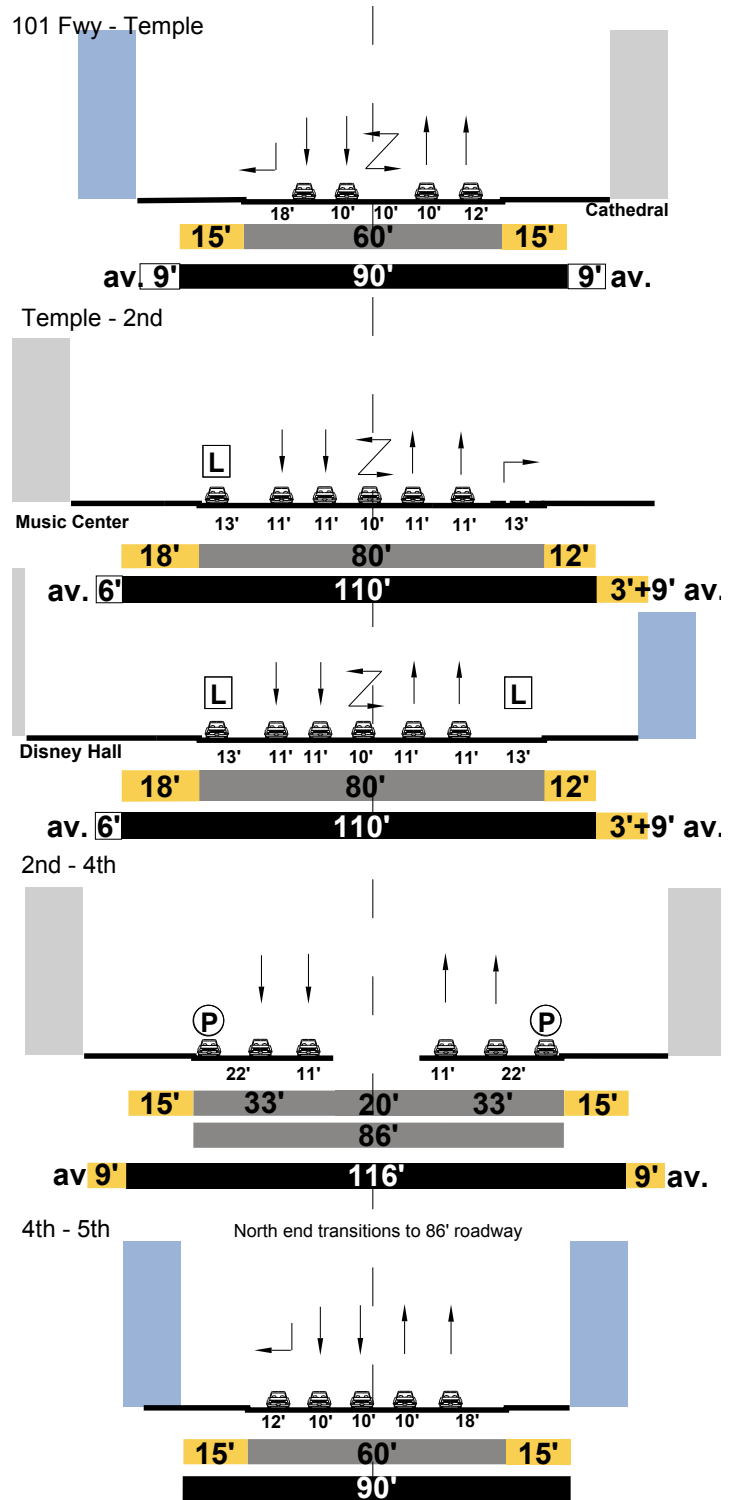
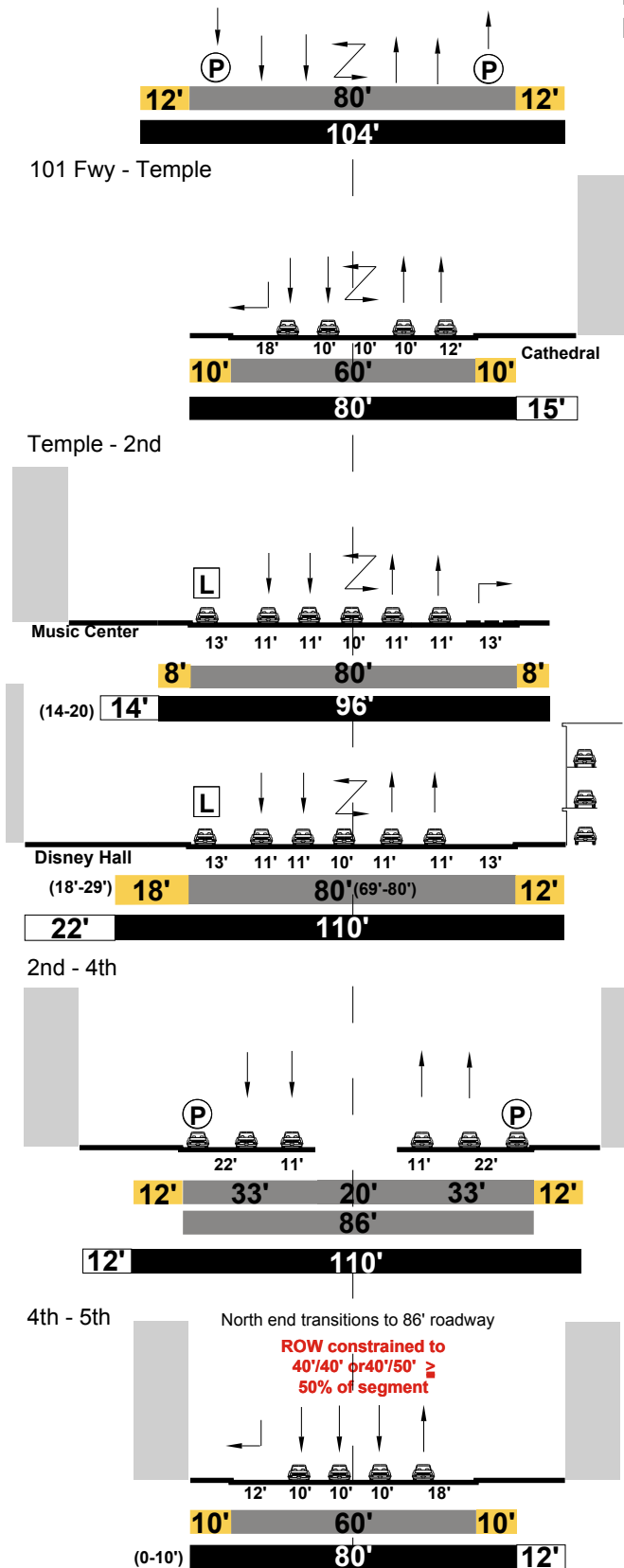

GRAND AVENUE looking north (continued)

EXISTING

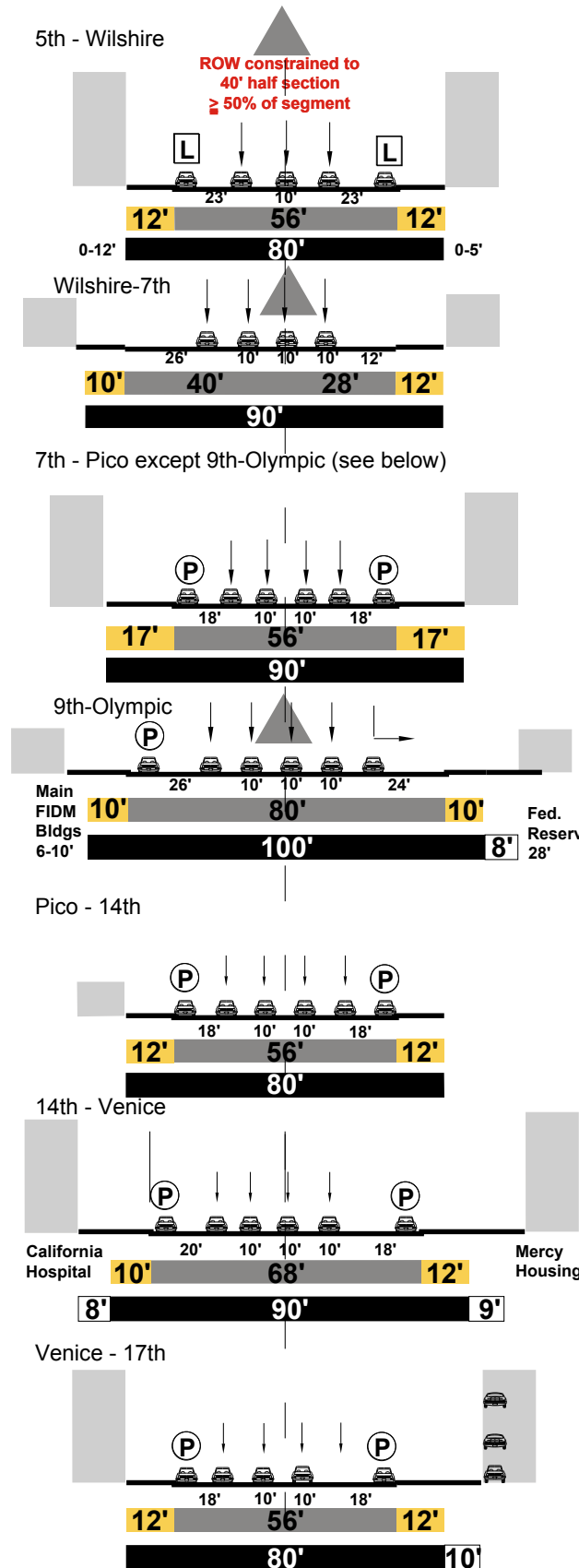

PROPOSED

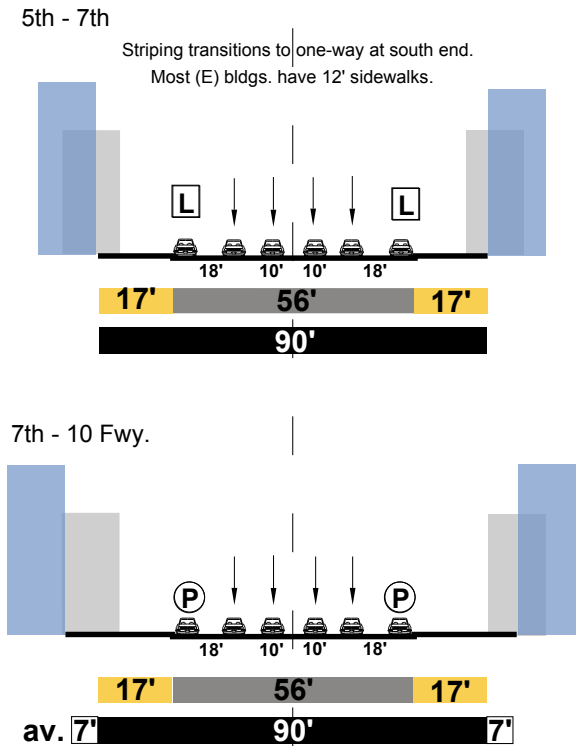

HOPE STREET looking north

EXISTING
Secondary

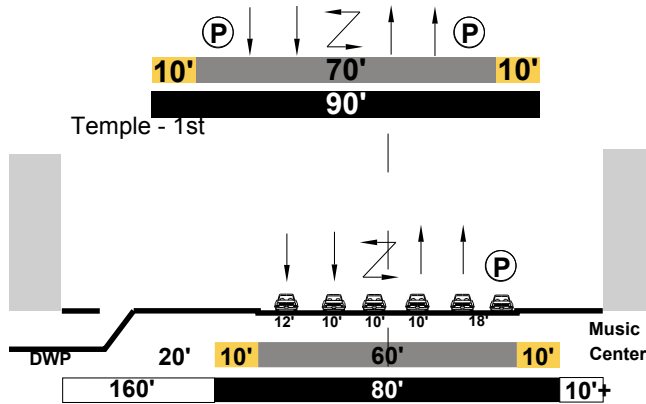

1st - GTK Way - varies

GTK Way - Hope Pl.

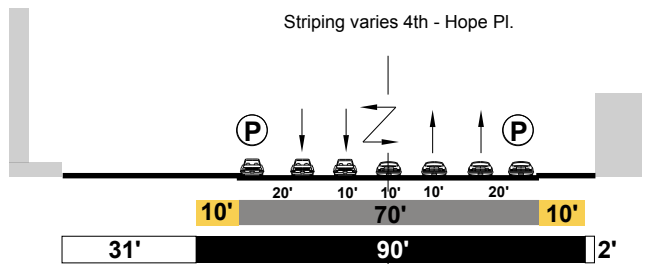

Library - 6th

ROW constrained to 40' half section
≥ 50% of segment

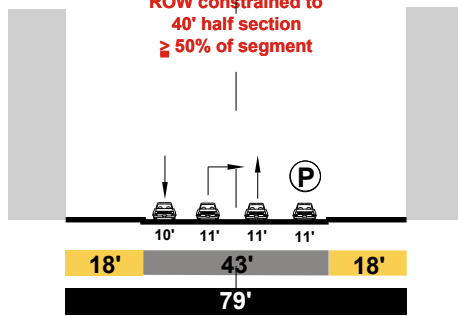

6th - 9th

ROW constrained to 40' half section
≥ 50% of segment

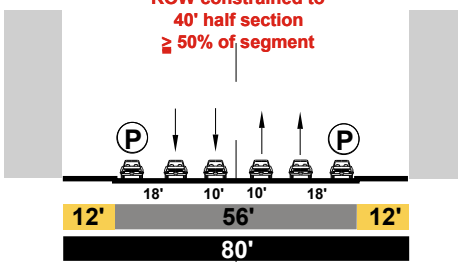

PROPOSED

Modified Avenue II north of 1ST St; 5TH St to Olympic Blvd
Modified Avenue I from 1ST St to 5TH St
Avenue II south of Olympic Blvd

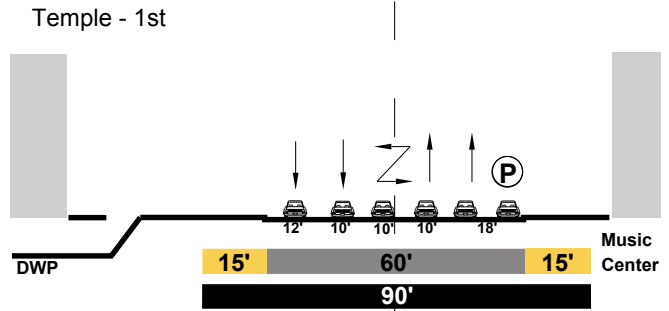

1st - GTK Way - varies - no change from existing

GTK Way - Hope Pl.

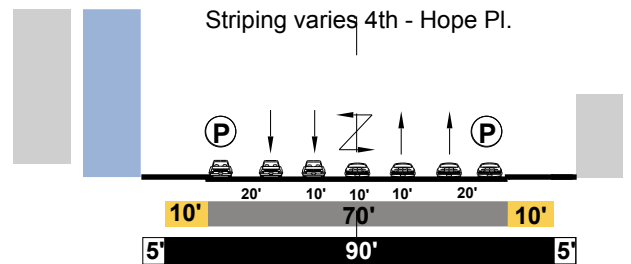

Library - 6th

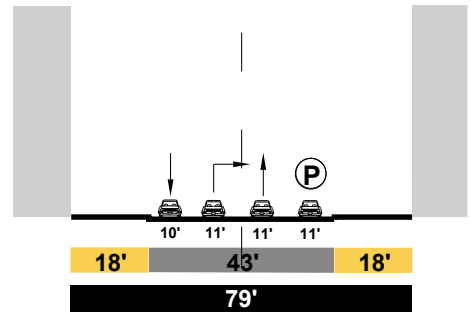

6th - Olympic (including 9th - Olympic)

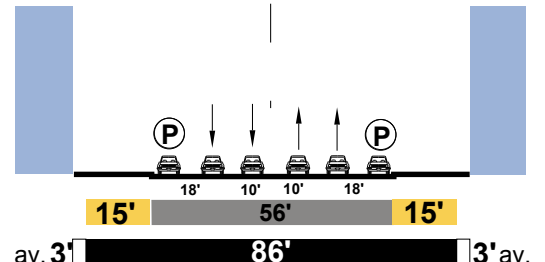

HOPE STREET looking north (continued) EXISTING

PROPOSED

9th - Olympic

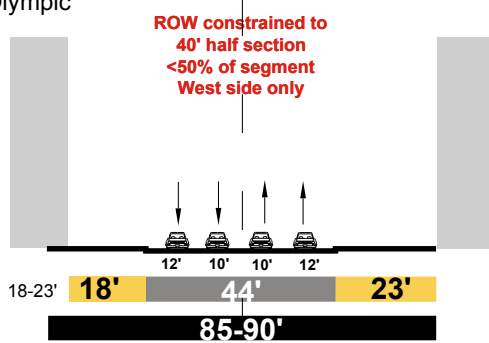

6th - Olympic (including 9th - Olympic)

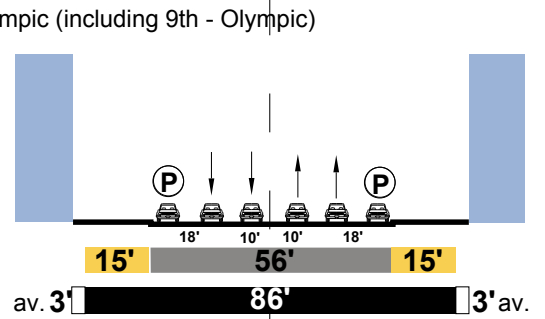

Olympic - Pico

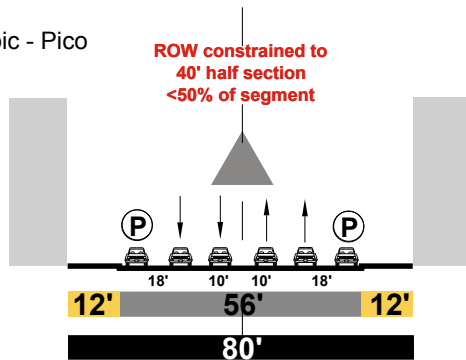

Olympic - Venice

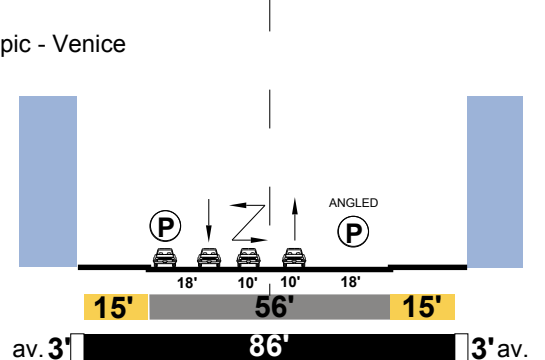

Pico - Venice

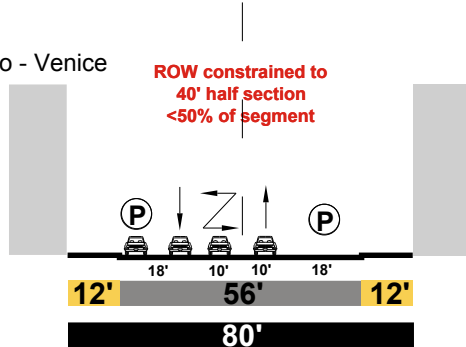

FLOWER STREET looking north
EXISTING
 Local 2nd - 3rd; Secondary south of 3rd

Designation: Secondary

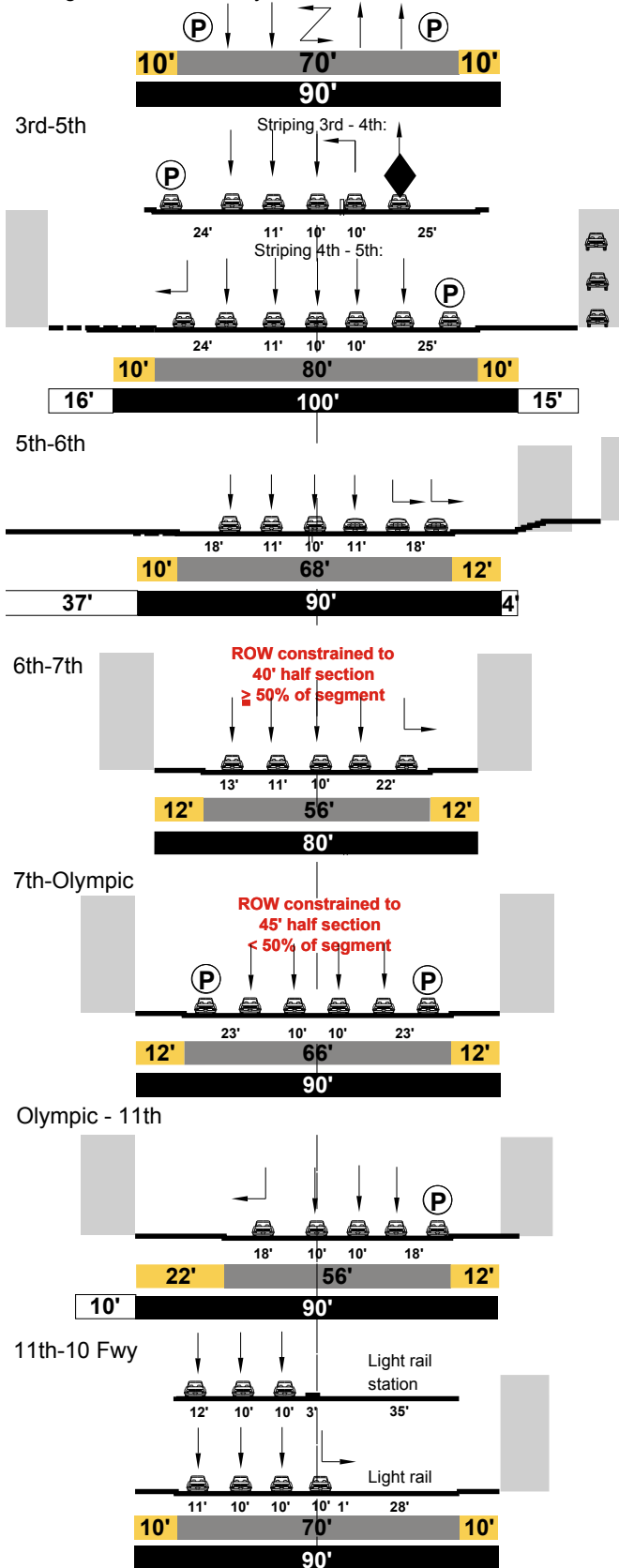

PROPOSED WITHOUT BICYCLE LANES
 Avenue II from 1ST St to 3RD St
 Avenue I from 3RD St to 6TH St
 Modified Avenue II from 6TH St to 11TH St
 Modified Avenue I south of 11TH St

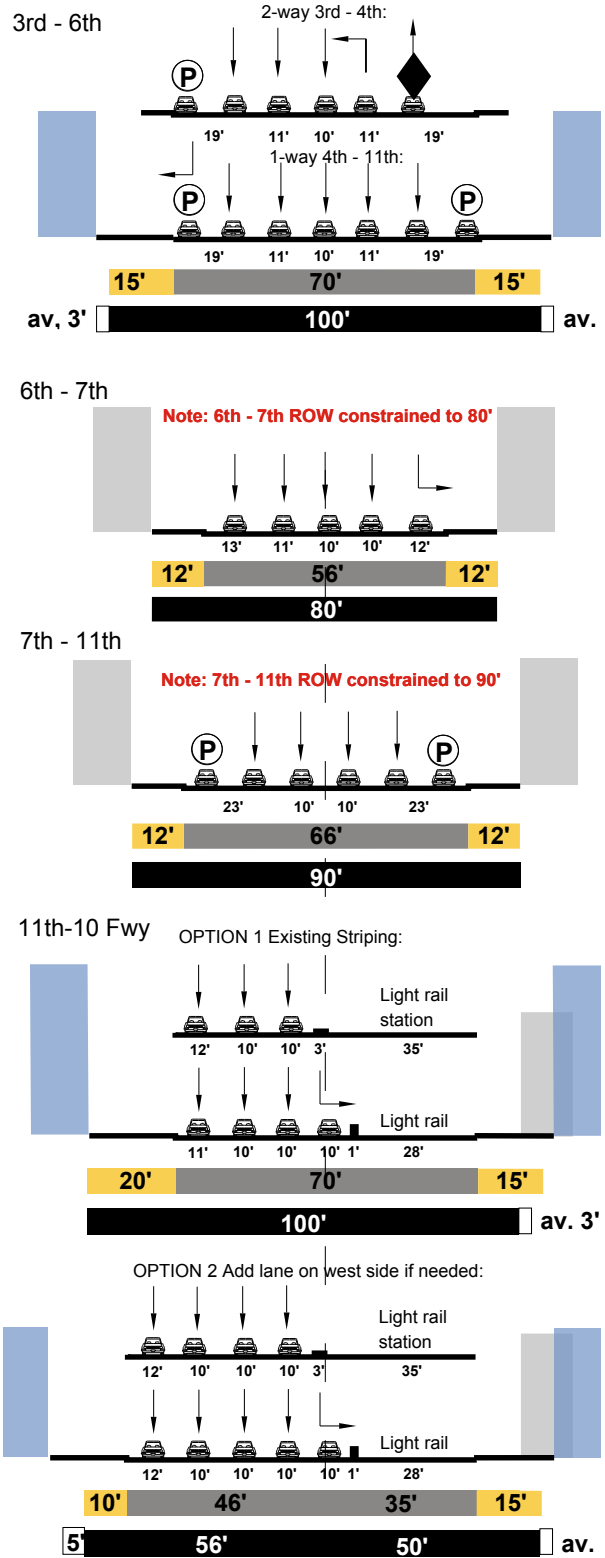

**FLOWER STREET looking north (continued)
EXISTING**

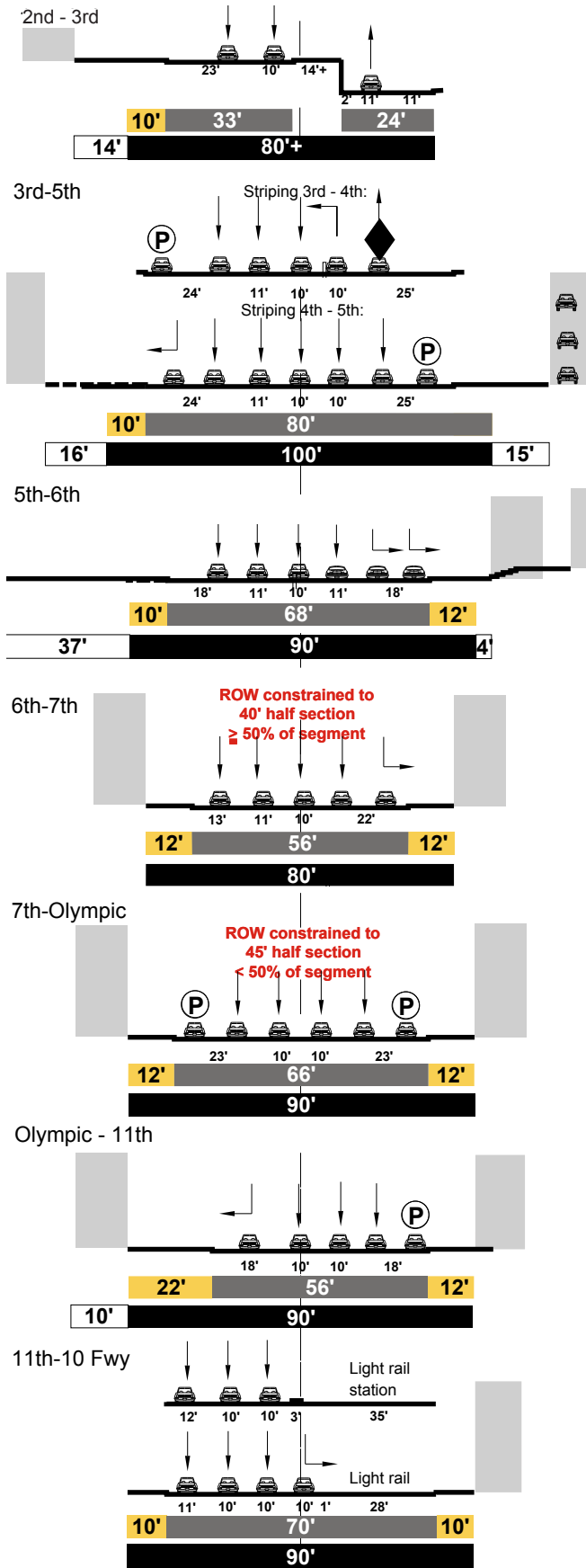

PROPOSED WITH BICYCLE LANES - PREFERRED

Avenue II from 1ST St to 3RD St
 Avenue I from 3RD St to 6TH St
 Modified Avenue II from 6TH St to 11TH St
 Modified Avenue I south of 11TH St

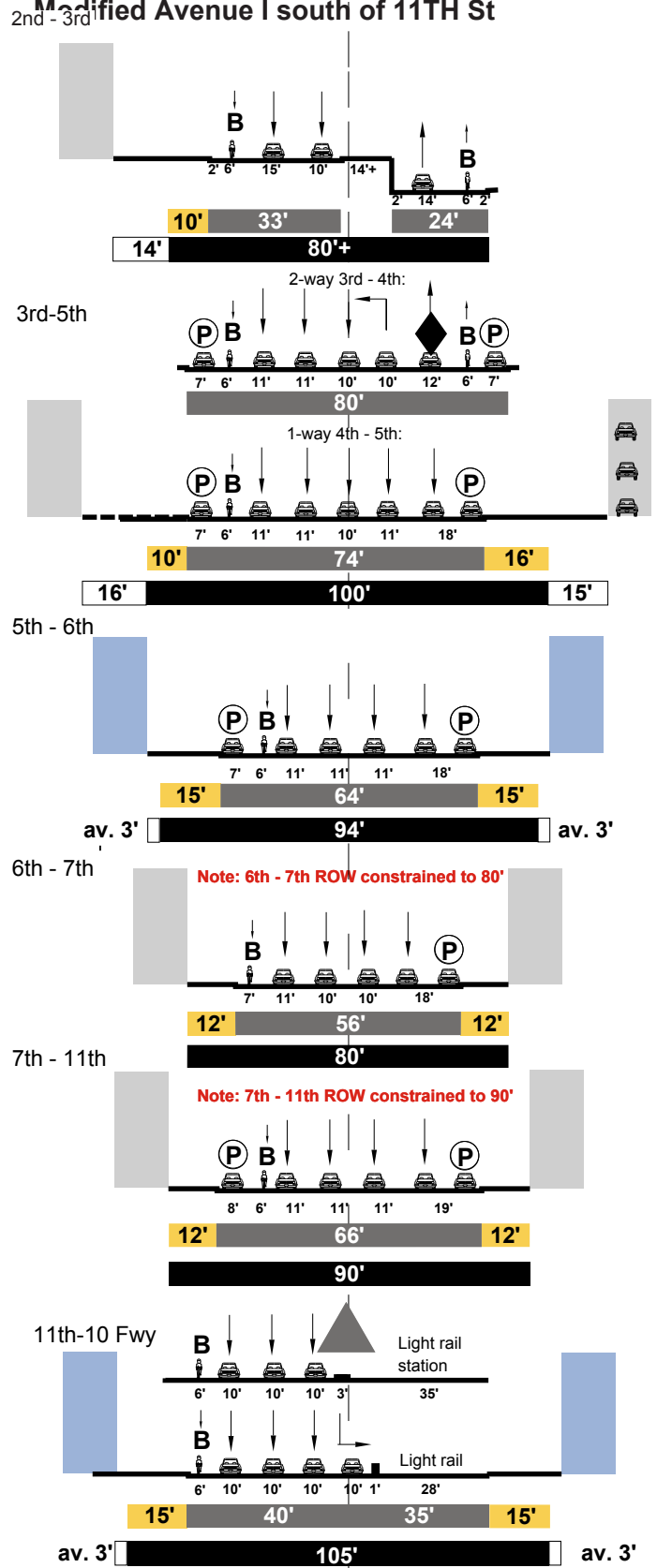

FIGUEROA STREET looking north
Major Class II

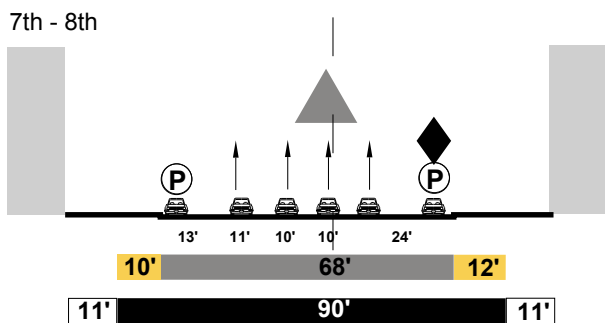
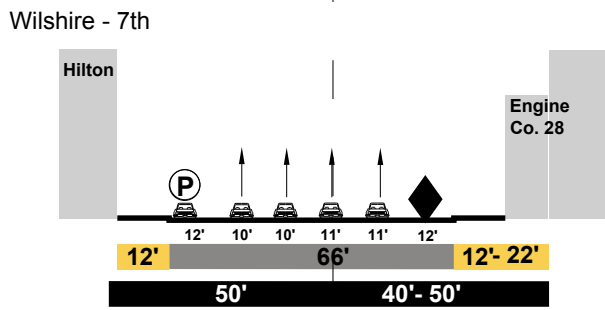
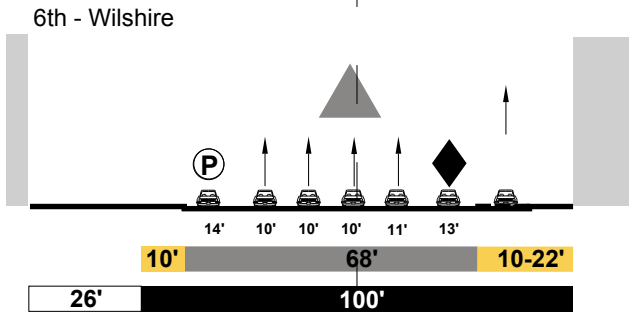
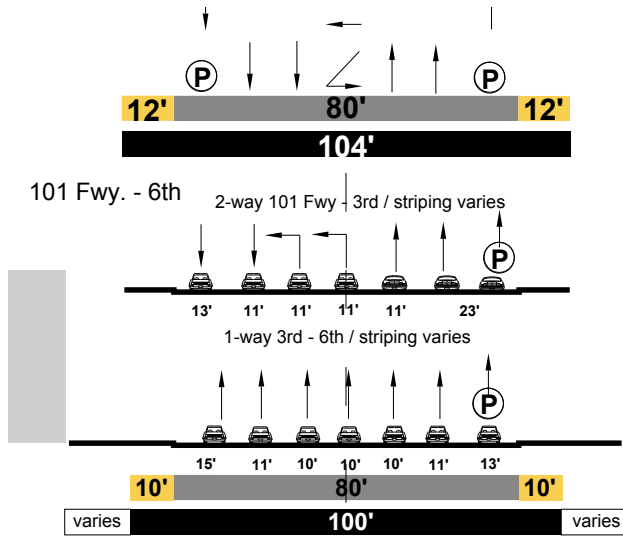

PROPOSED - WITHOUT BIKE LANE
Boulevard II north of Wilshire
Avenue I from Wilshire to Olympic Blvd
Modified Boulevard II south of Olympic Blvd

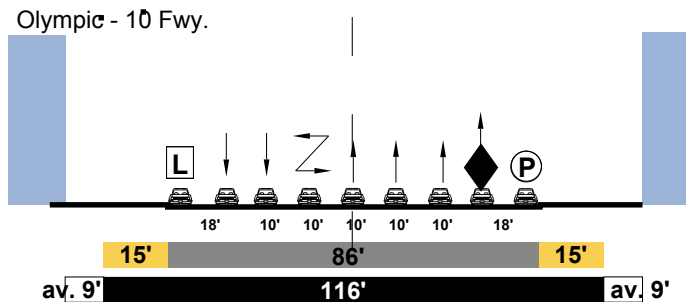
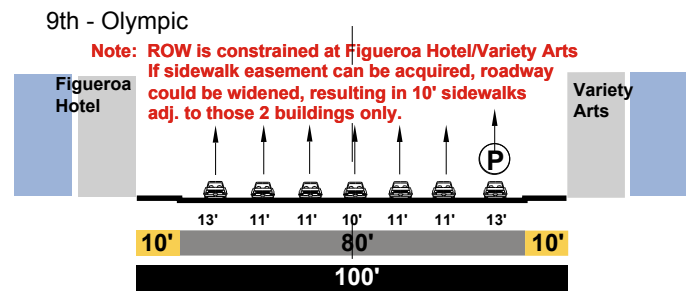
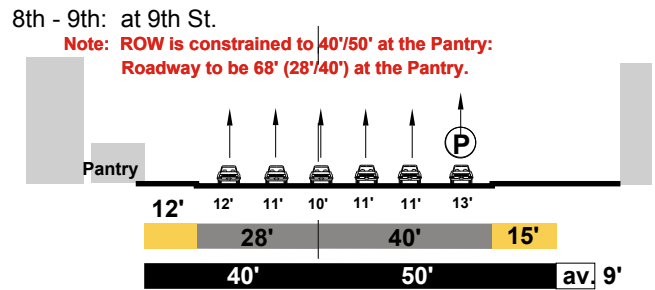
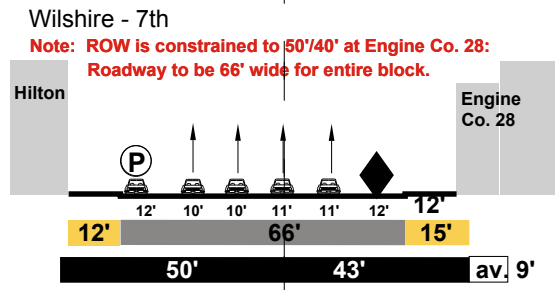
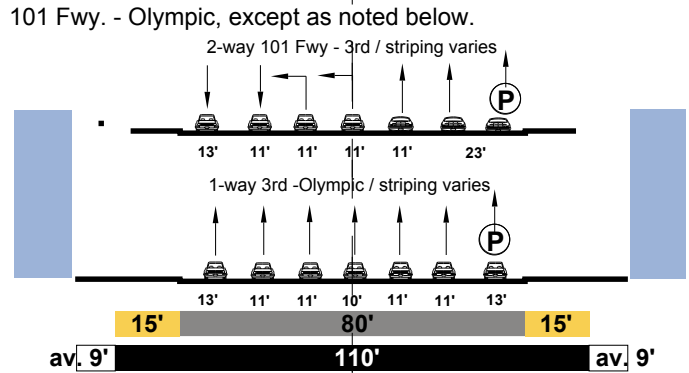

FIGUEROA STREET looking north (continued)
EXISTING

8th - 9th: midblock

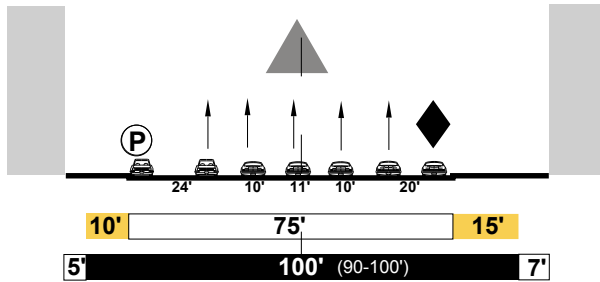

8th - 9th: at 9th St.

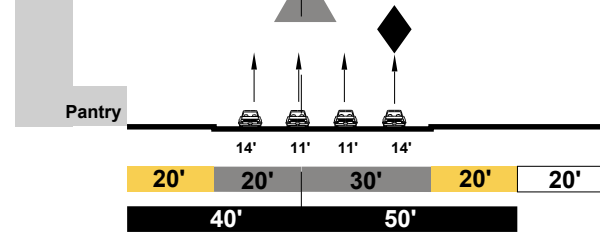

9th - Olympic

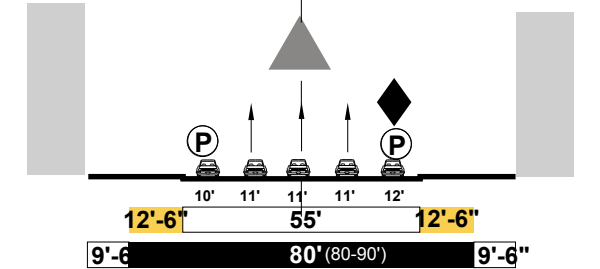

Olympic - Pico

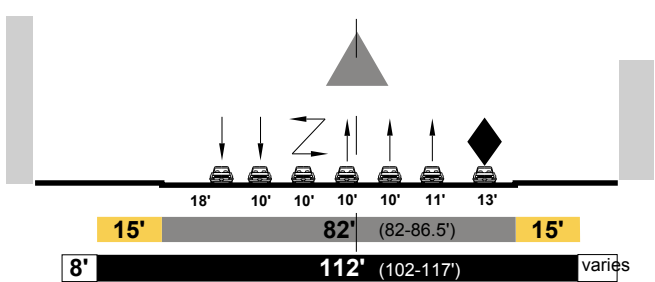

Pico - 10 Fwy.

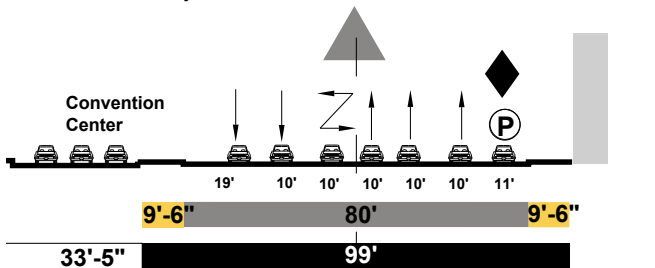

PROPOSED - WITH BIKE LANE - PREFERRED
Boulevard II north of Wilshire
Avenue I from Wilshire to Olympic Blvd
Modified Boulevard II south of Olympic Blvd

101 Fwy. - Olympic

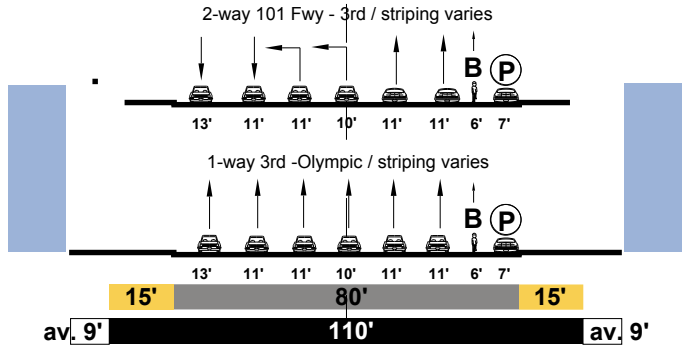

Wilshire - 7th

**Note: ROW is constrained to 50'/40' at Engine Co. 28:
 Roadway to be 66' wide for entire block.**

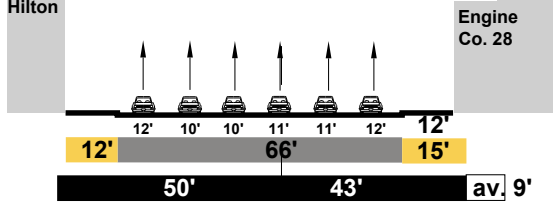

8th - 9th: at the Pantry

**Note: ROW is constrained to 40'/50' at the Pantry:
 Roadway to be 68' (28'/40') at the Pantry.**

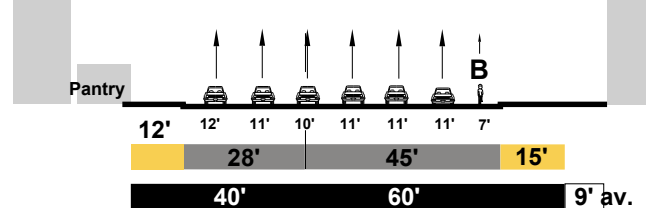

9th - Olympic at Figueroa Hotel & Variety Arts

**Note: ROW is constrained at Figueroa Hotel/Variety Arts
 If sidewalk easement can be acquired, roadway
 could be widened, resulting in 10' sidewalks
 adj. to those 2 buildings only.**

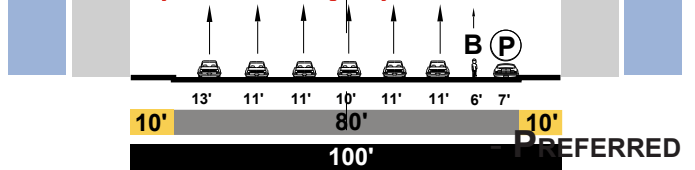

Olympic - 10 Fwy.

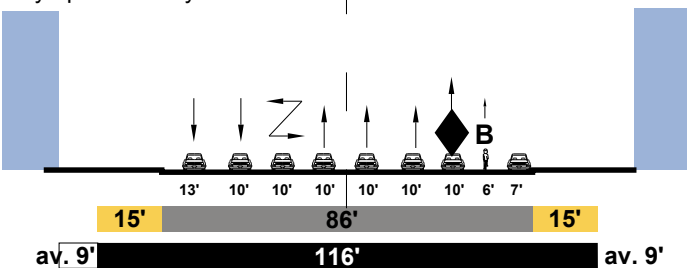

EAST - WEST STREETS

TEMPLE STREET looking west

Major Class II

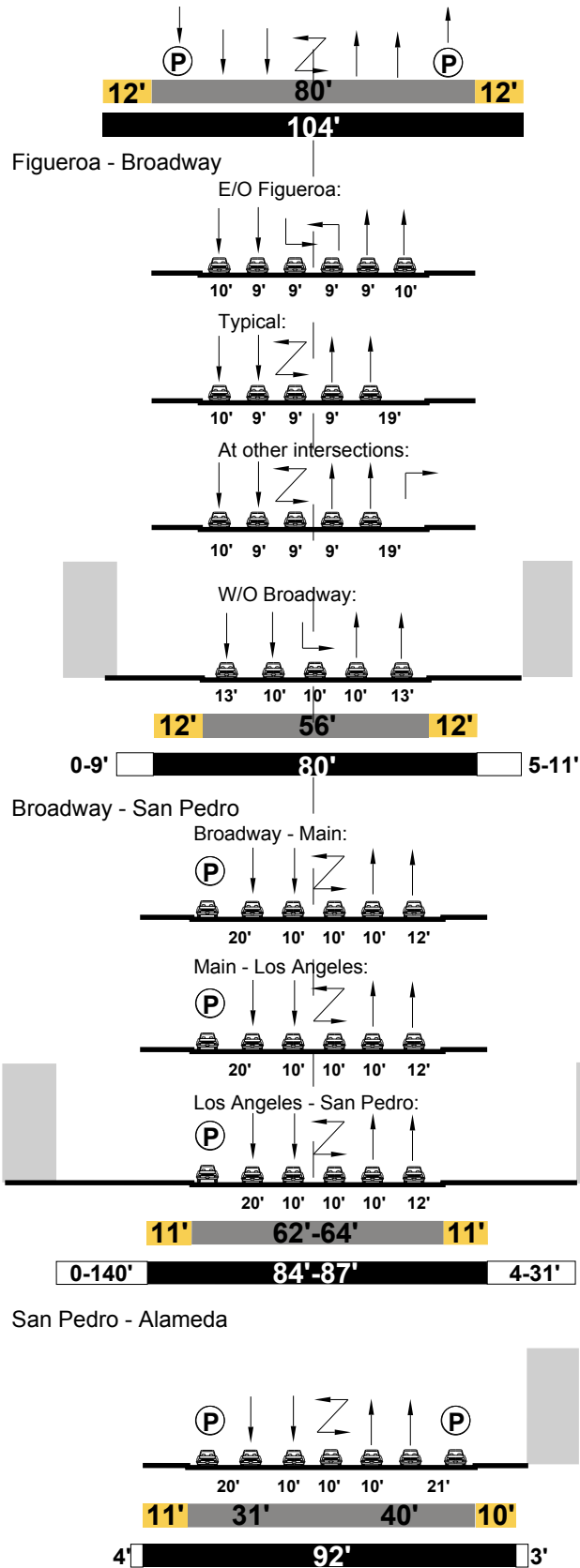

Proposed

Avenue II west of Broadway

Modified Avenue II east of Broadway

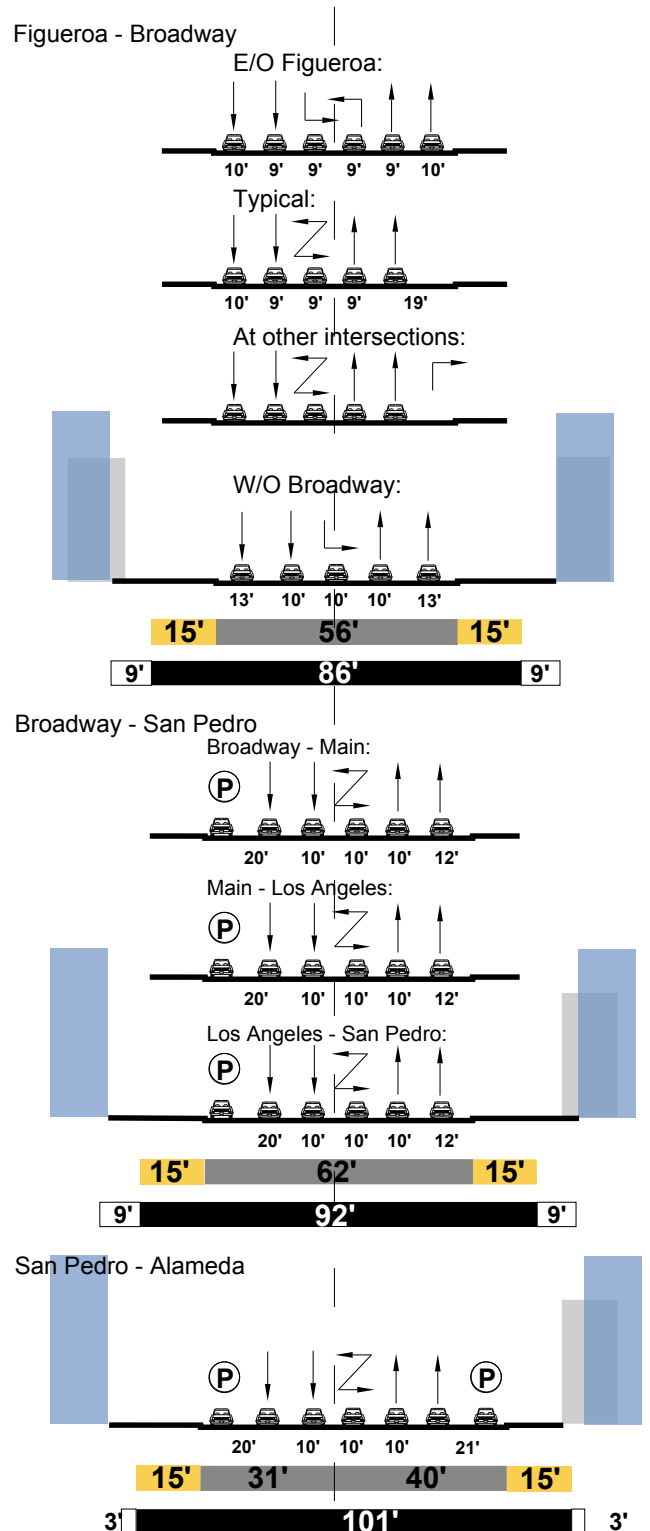

1ST STREET looking west

EXISTING

Major Class III

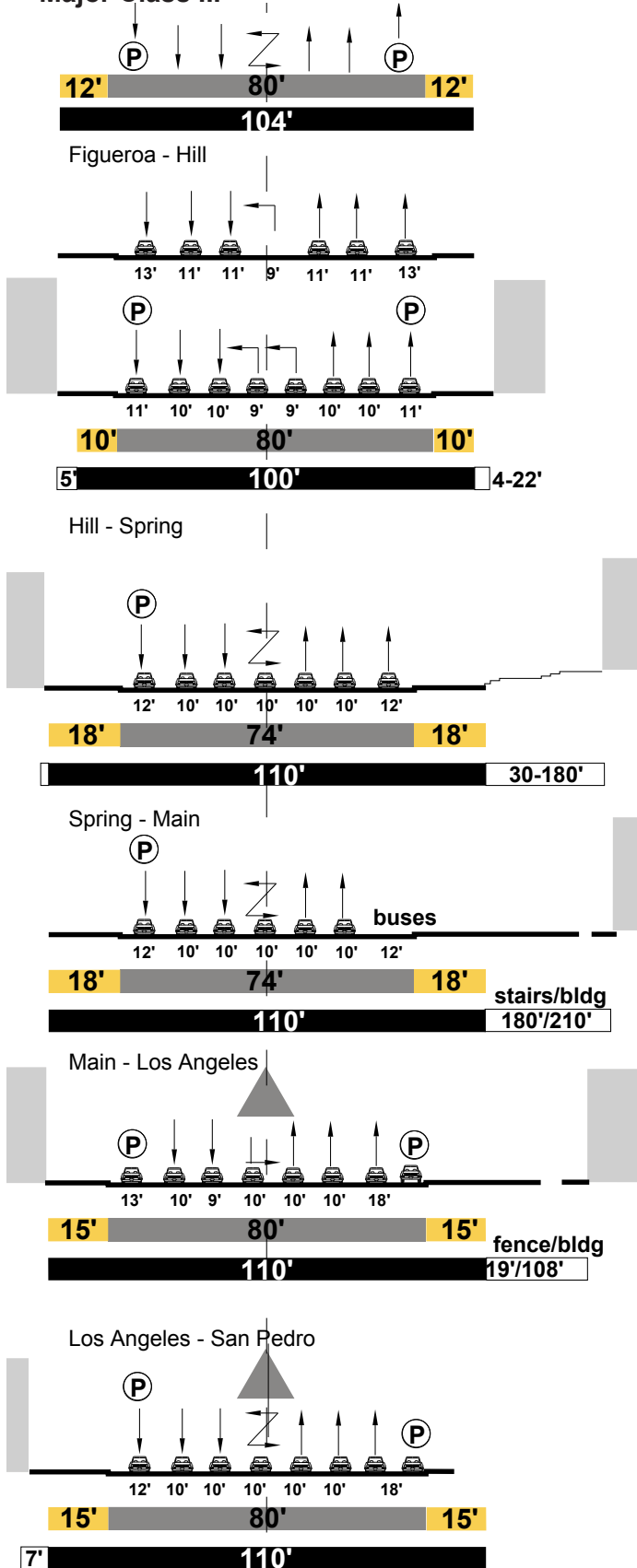

Proposed

Boulevard II west of Hill St

Modified Boulevard II from Hill St to Judge John Aliso Modified Avenue II from Judge John Aliso to Alameda St

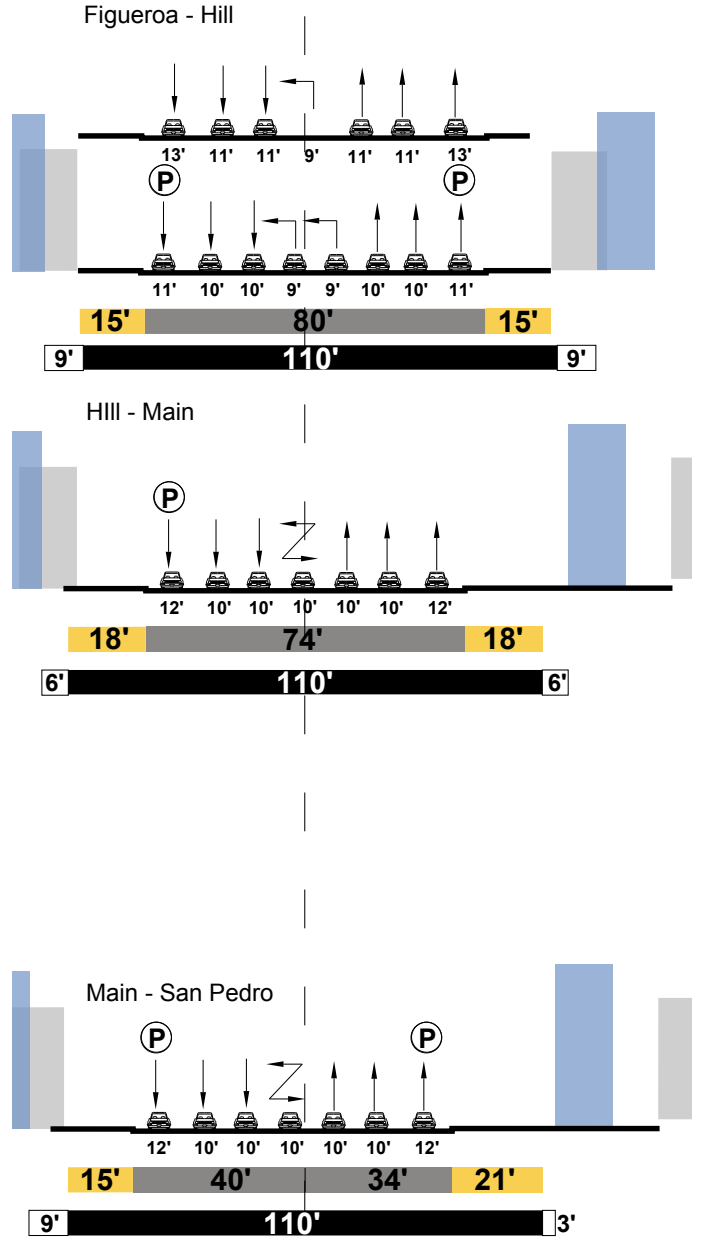

1ST STREET looking west (continued)
EXISTING

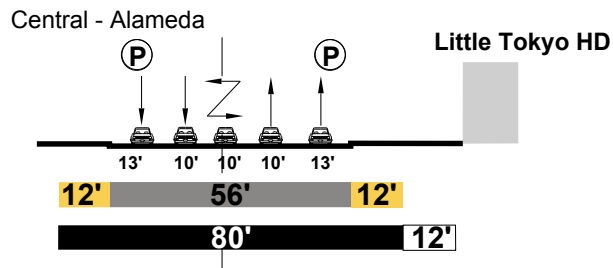
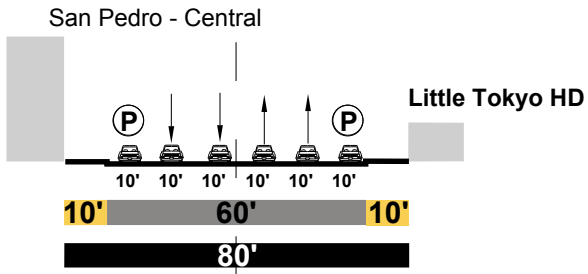

PROPOSED

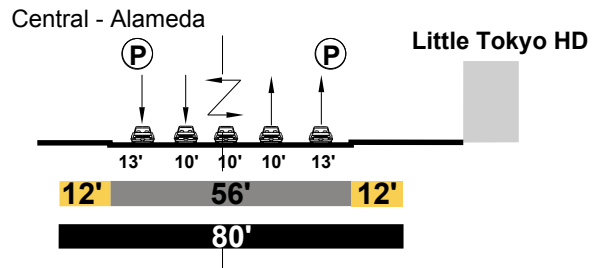
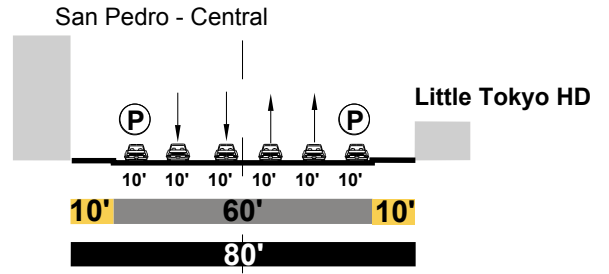

2ND Street looking west

Existing

Secondary west of Los Angeles; Collector east

Designation: Secondary - Figueroa to Los Angeles

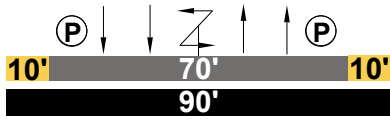

Tunnel between Figueroa & Hill

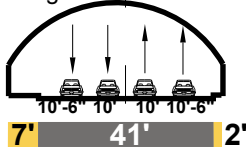

East end of tunnel - Hill

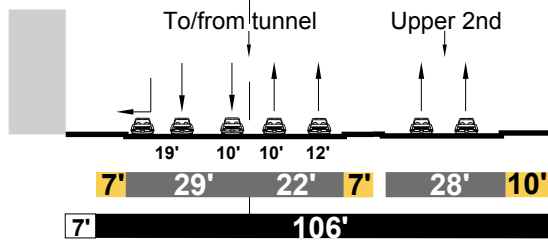

Hill - Broadway

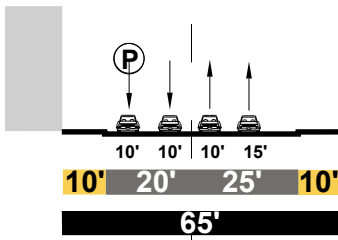

Broadway - Spring

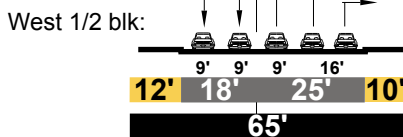

East 1/2 blk:

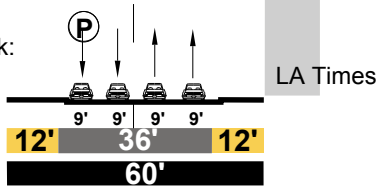

Spring - Main

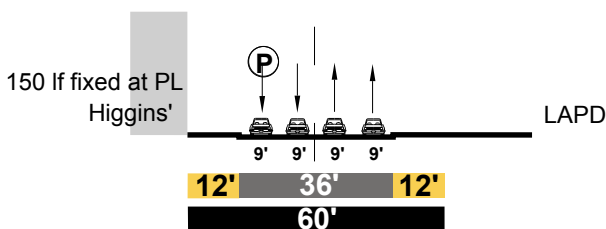

PROPOSED WITH BICYCLE LANES

Modified Avenue III from Figueroa to Judge John Aliso
Modified Collector Streets from Judge John Aliso to Alameda St

Tunnel between Figueroa & Hill

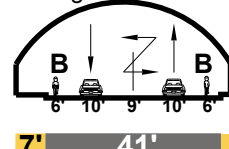

East end of tunnel - Hill

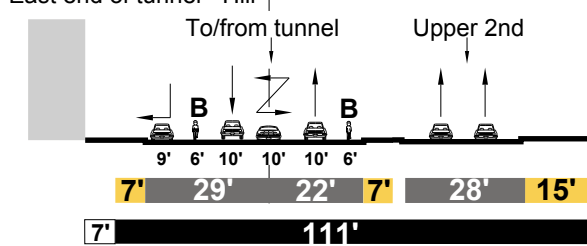

Hill - Broadway

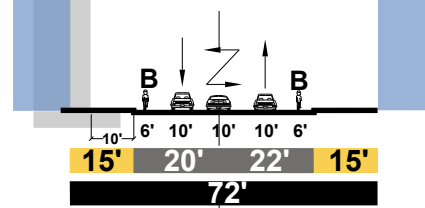

Broadway - Spring
West 1/2 blk:

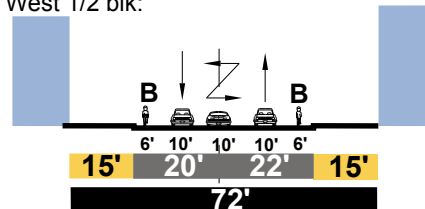

East 1/2 blk:

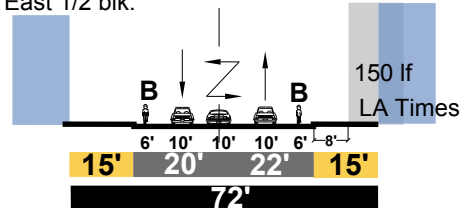

Spring - Main

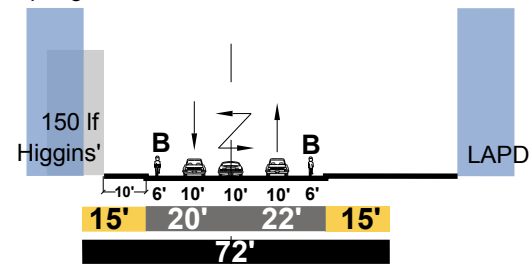

2ND STREET looking west (continued) EXISTING

PROPOSED WITH BICYCLE LANES

Designation: Secondary - Figueroa to Los Angeles

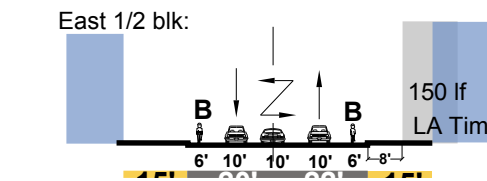
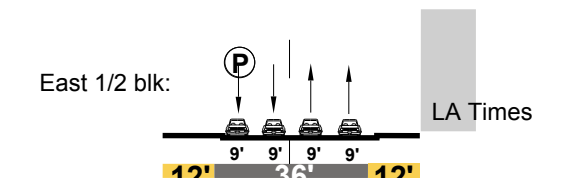
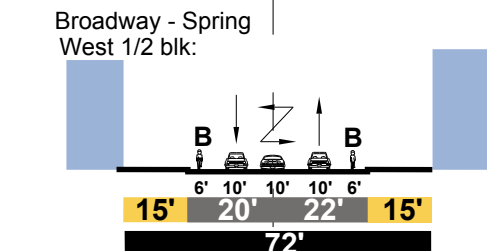
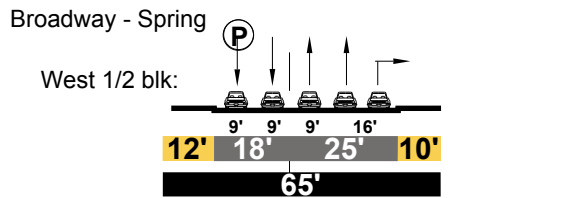
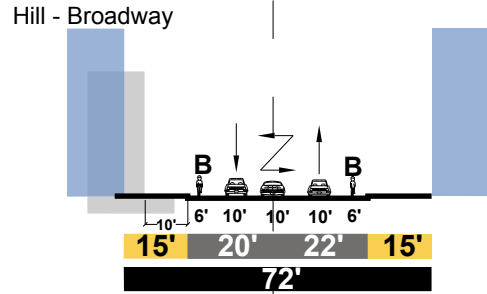
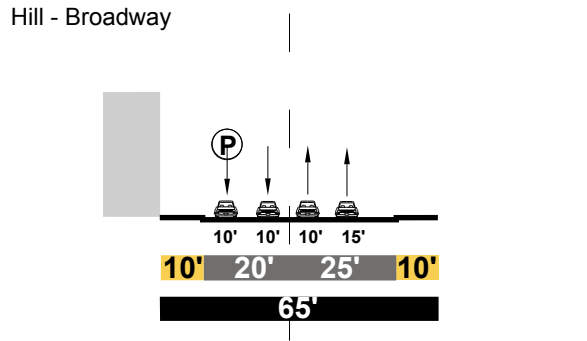
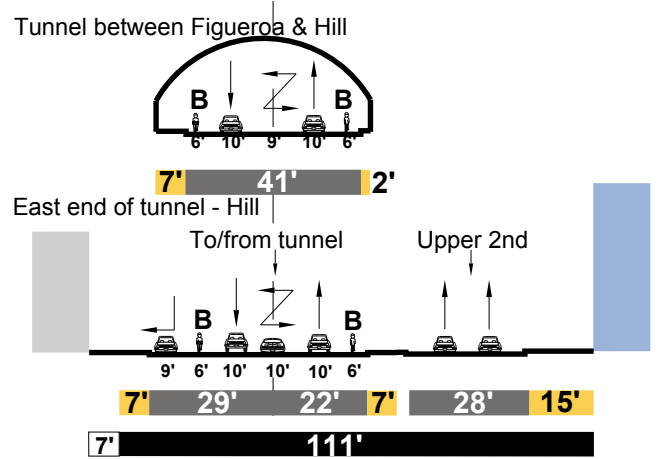
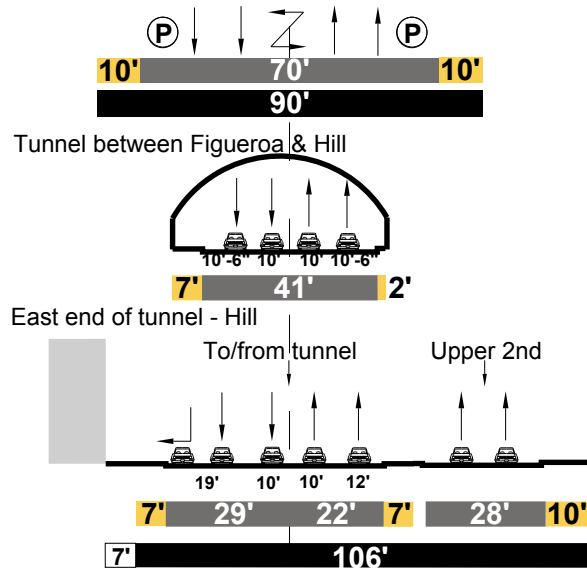

3RD STREET looking west
EXISTING
 Secondary

Designation: Secondary

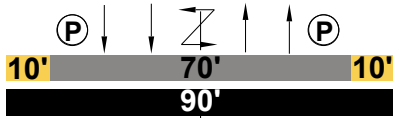

Figueroa - Flower

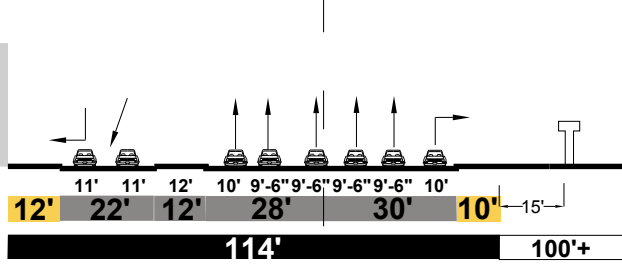

PROPOSED

Modified Boulevard II from Figueroa St to Flower St
 Modified Avenue II from Flower St to Hope St
 Modified Avenue III Hope St to Los Angeles St
 Avenue II from Los Angeles St to Alameda St

Figueroa - Flower

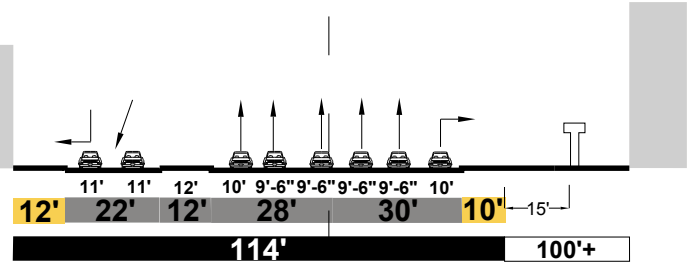

Flower - tunnel (Hope)

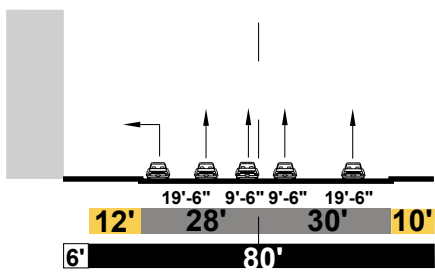

Flower - tunnel (Hope)

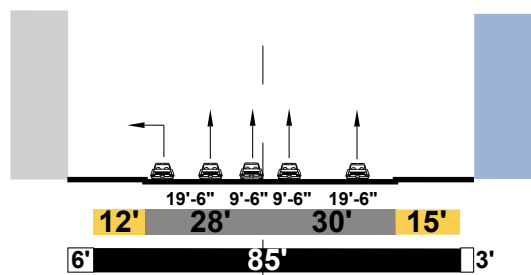

Hope - Hill

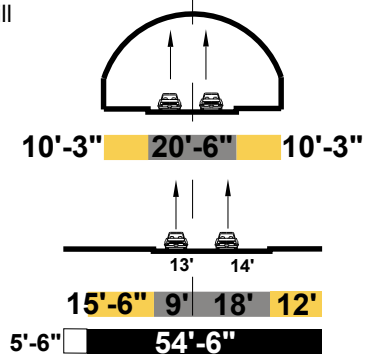

Hope - Hill

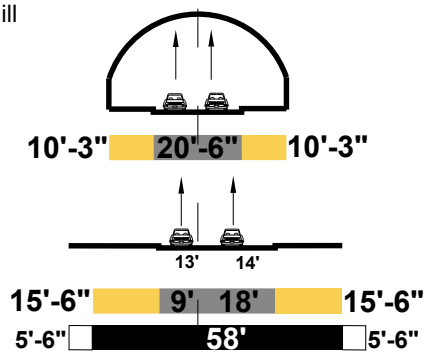

Hill - Spring

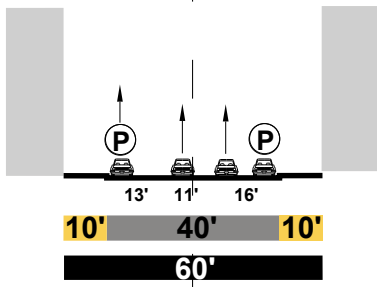

Hill - Spring

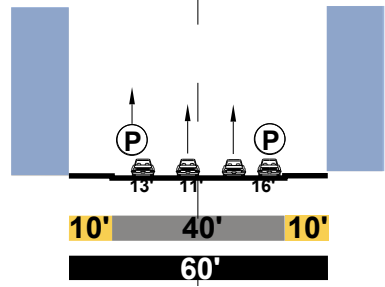

3RD STREET looking west (continued) EXISTING

Spring - Main

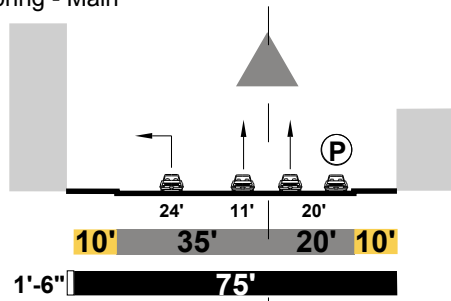

Main - Los Angeles

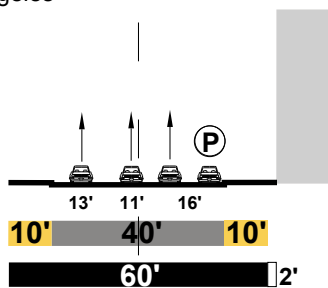

Los Angeles - San Pedro

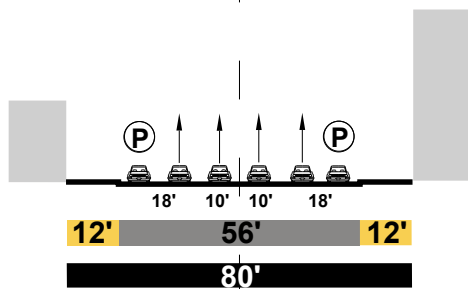

San Pedro - Central

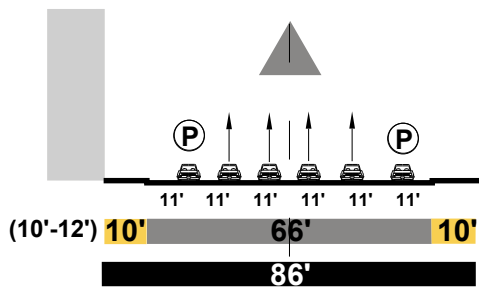

Central - Alameda

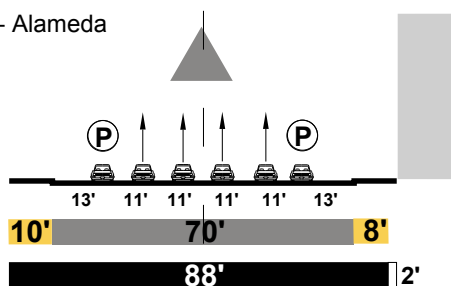

PROPOSED

Spring - Los Angeles

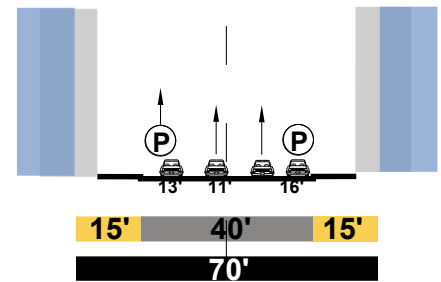

Los Angeles - Alameda

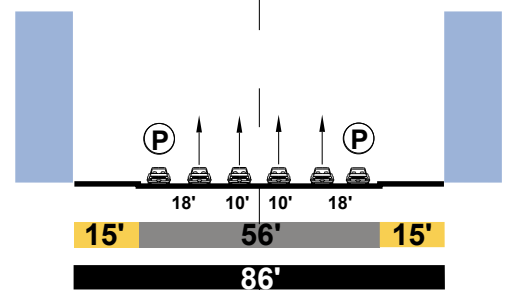

4TH STREET looking west
EXISTING
 Boulevard II
 Secondary

PROPOSED
 Modified Boulevard II from Hope St to Grand Ave
 Modified Avenue I from Figueroa St to Hope St; Grand Ave to Olive St
 Modified Avenue II from Olive St to Hill St
 Modified Avenue III from Hill St to Los Angeles St
 Avenue III from Los Angeles St to Judge John Aliso
 Avenue II from Judge John Aliso to Alameda

NO CHANGE FROM EXISTING

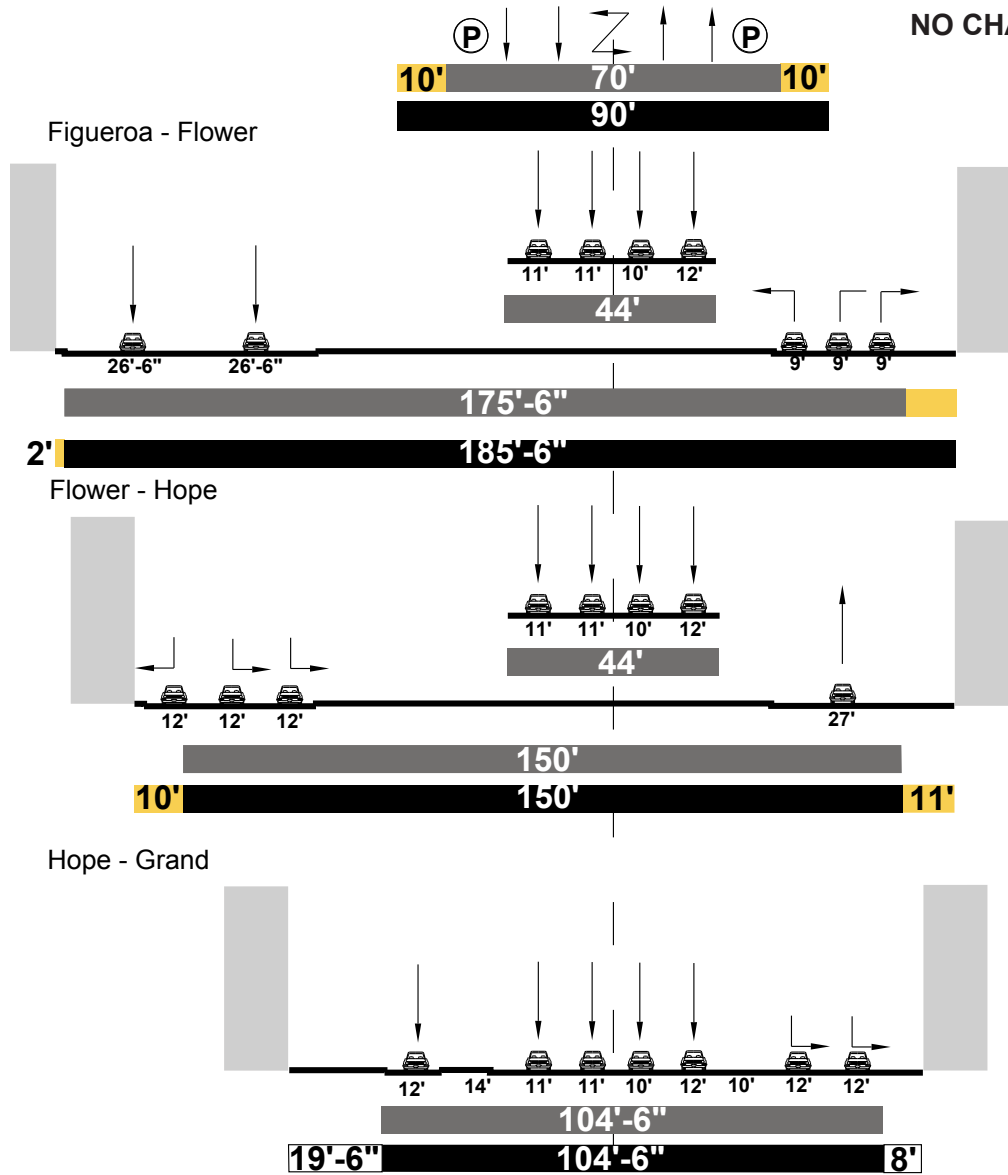

4TH STREET looking west (continued)

EXISTING
Grand - Olive

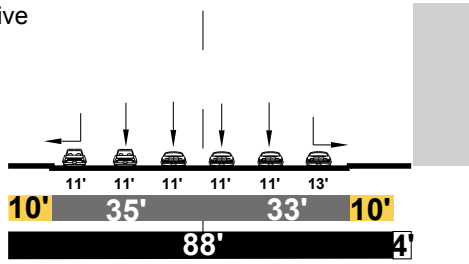

PROPOSED
Grand - Olive

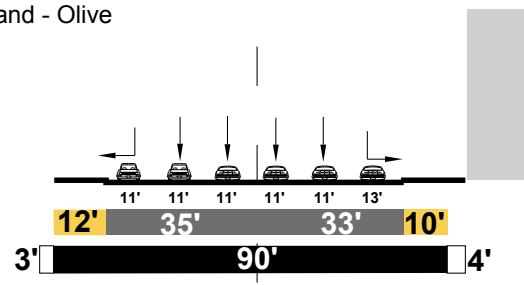

Olive - midblock Hill/Broadway

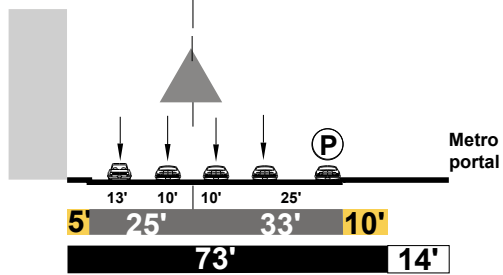

Olive - Hill

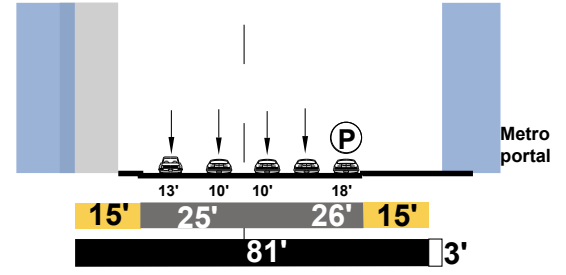

midblock Hill/Broadway - Main

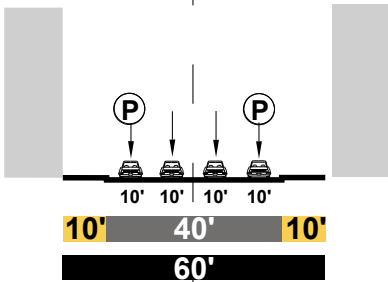

Hill - Main

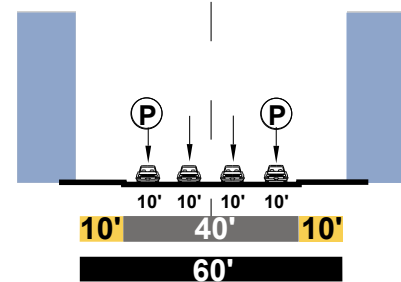

Main - Wall

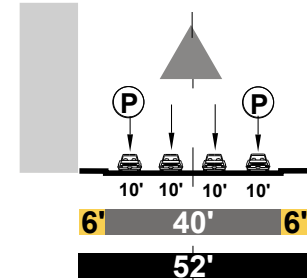

Main - Los Angeles

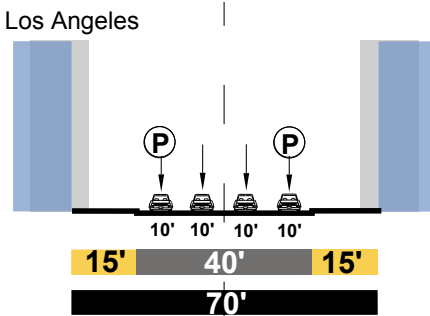

Wall - San Pedro

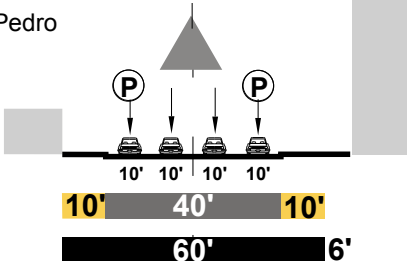

Los Angeles - Central

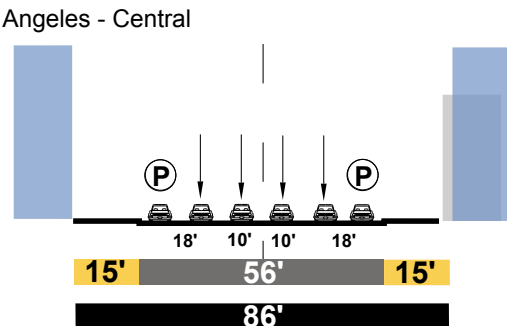

San Pedro - Central

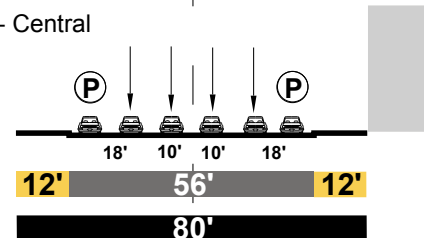

5TH STREET looking west
EXISTING

Secondary

5TH STREET looking west EXISTING

Designation: Secondary

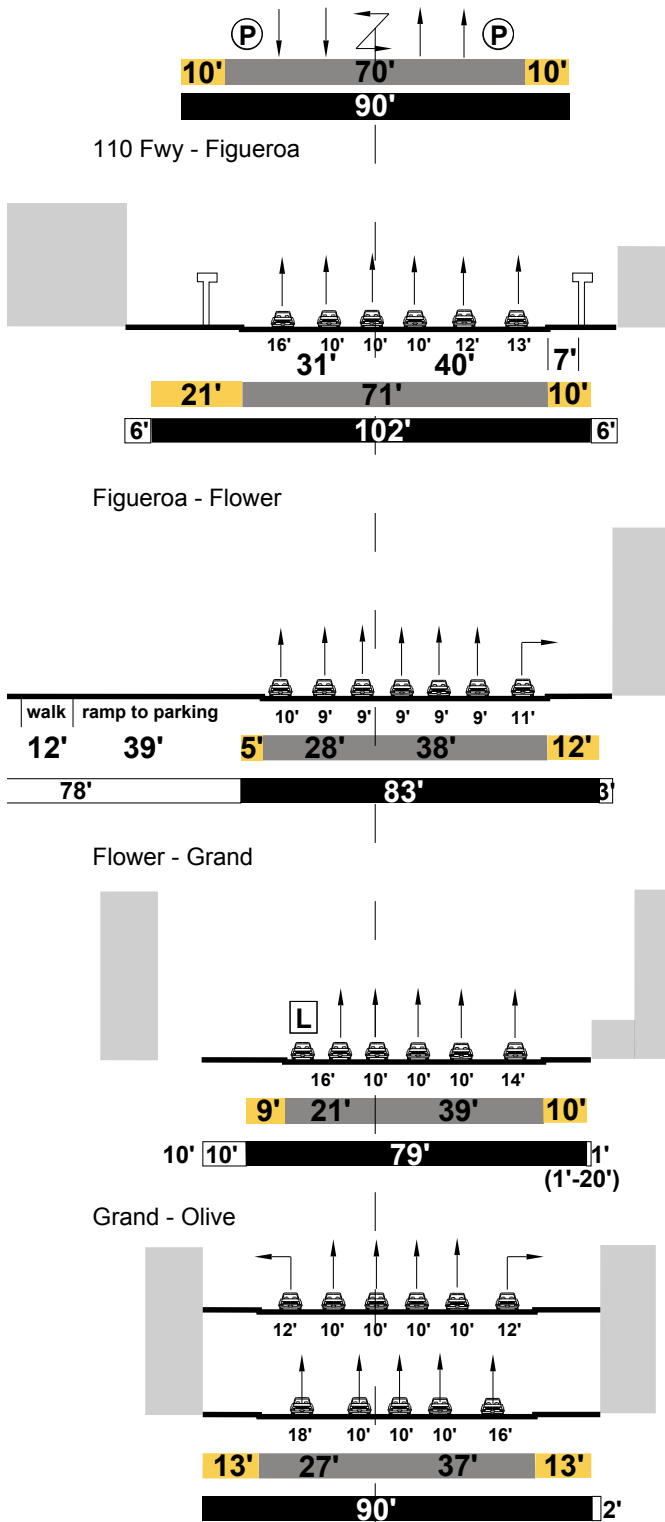

PROPOSED

Avenue I from Figueroa St to Flower St
Modified Avenue II from Flower St to Hill St
Modified Avenue III from Hill St to Los Angeles St
Avenue II from Los Angeles St to Central Ave

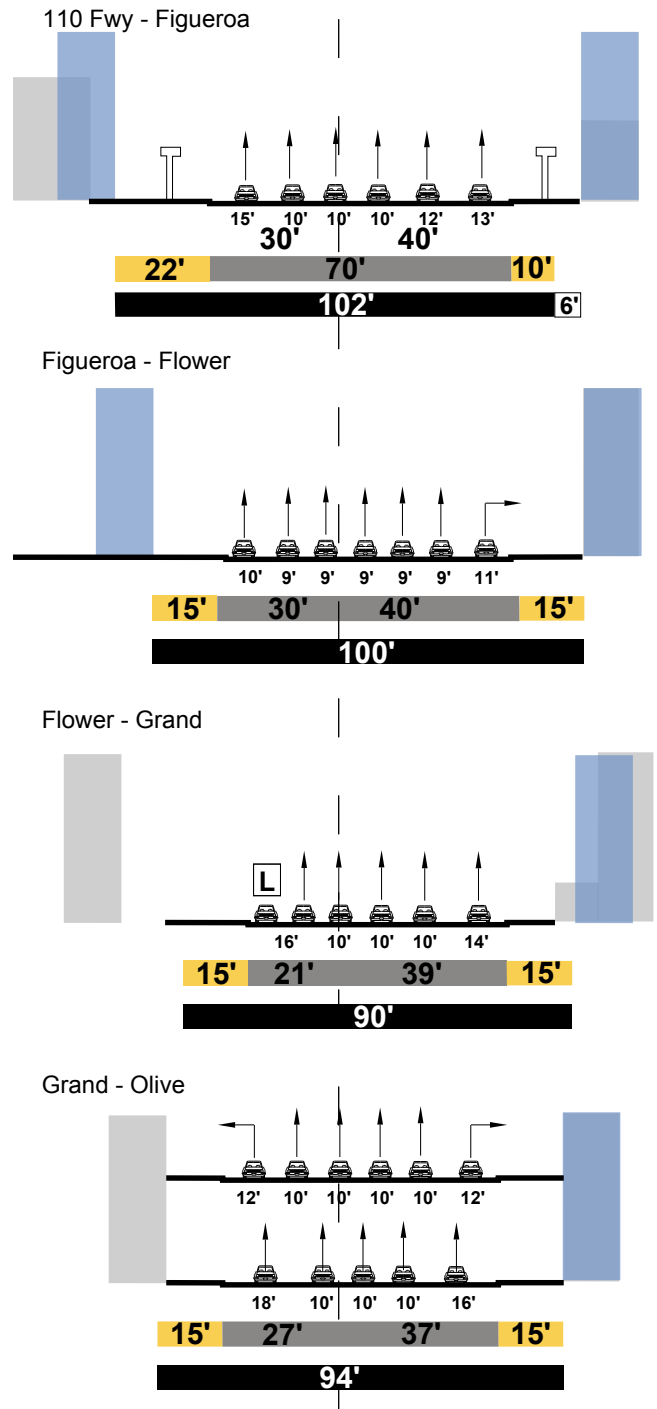

5TH STREET looking west (continued) EXISTING

PROPOSED

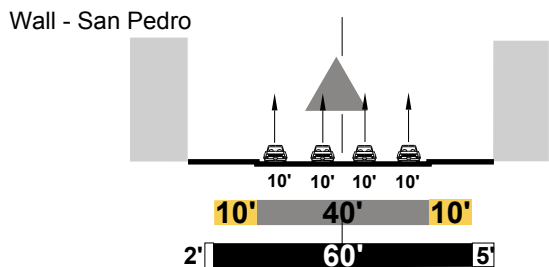
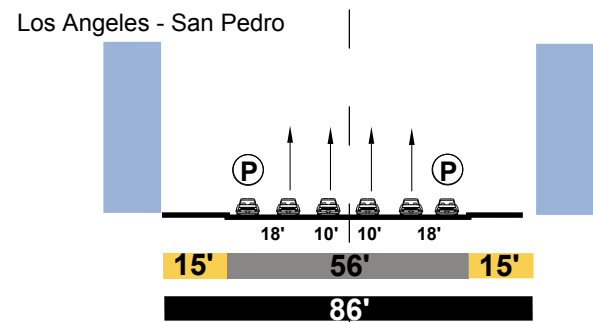
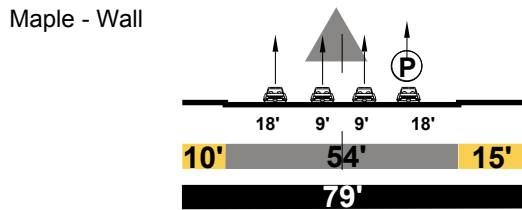
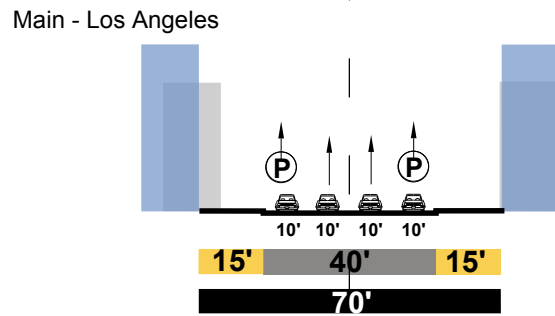
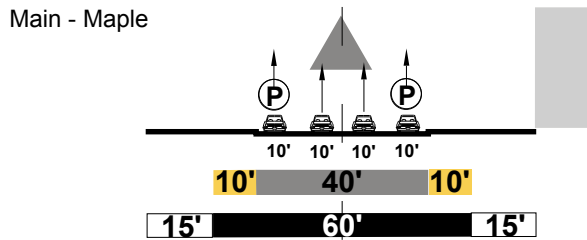
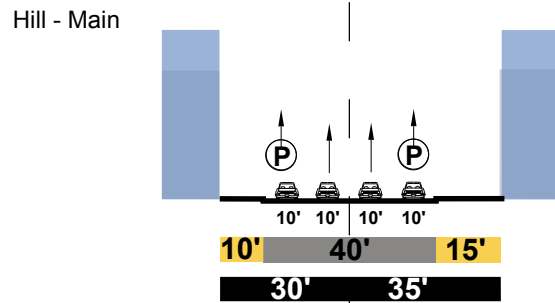
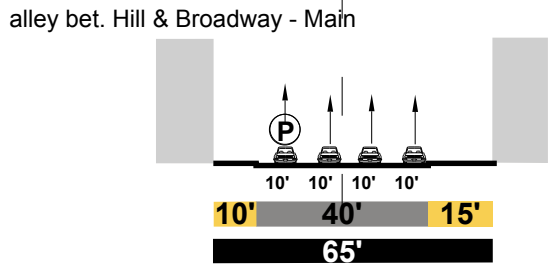
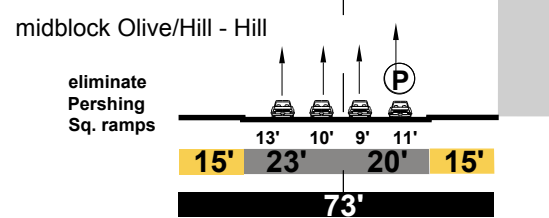
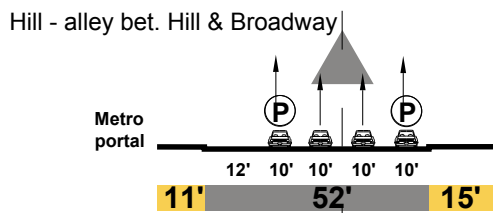
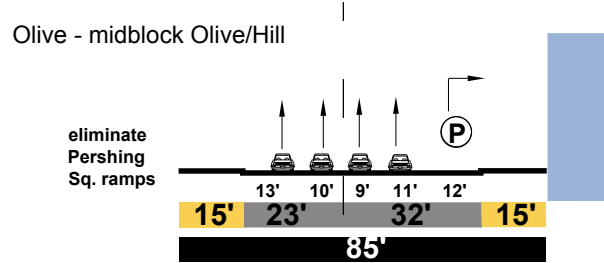
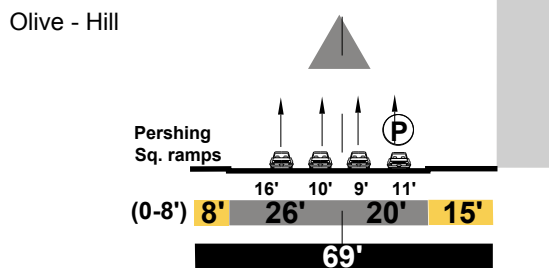

6TH STREET looking west
EXISTING
 Secondary

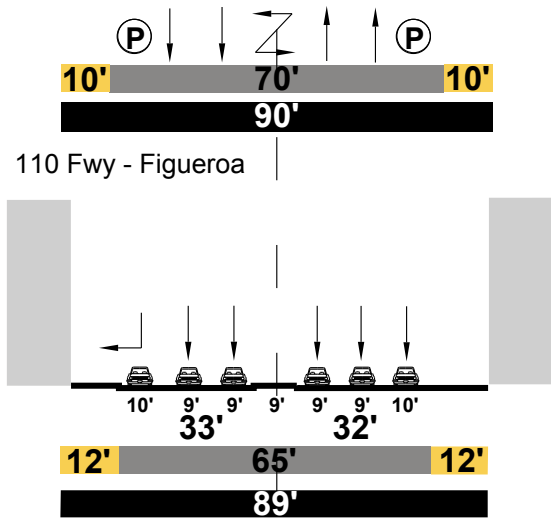

PROPOSED
 Modified Avenue I 110 FWY to Flower St
 Modified Avenue III Flower St to Los Angeles St
 Avenue II east of Los Angeles St

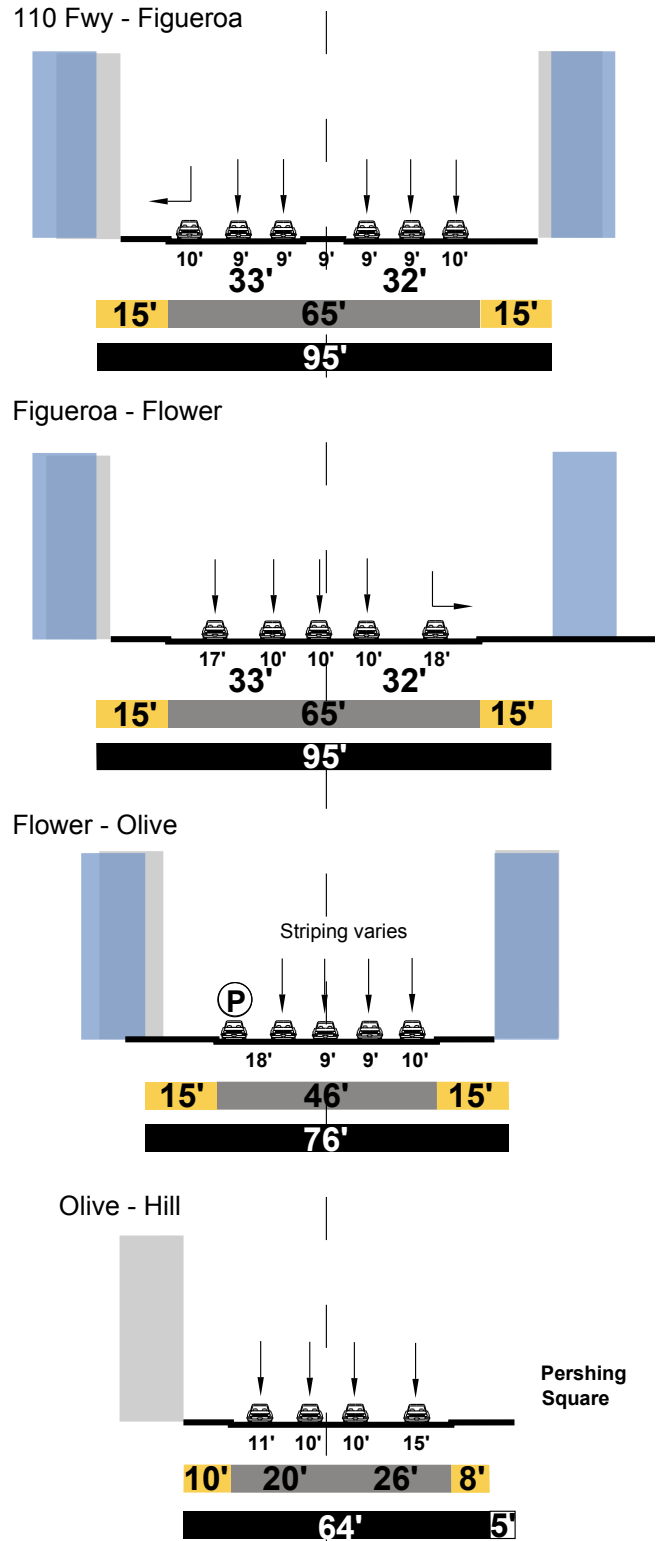

6TH STREET looking west (continued) EXISTING

Hill - alley bet. Hill/Broadway

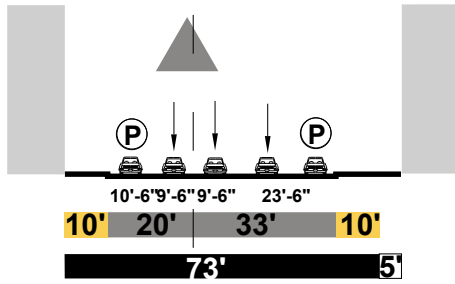

alley bet. Hill/Broadway - Los Angeles

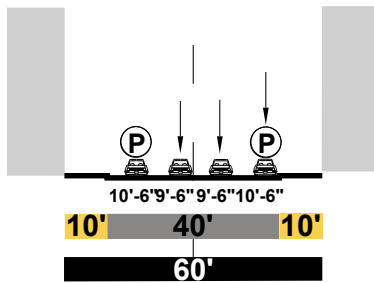

Los Angeles - Maple

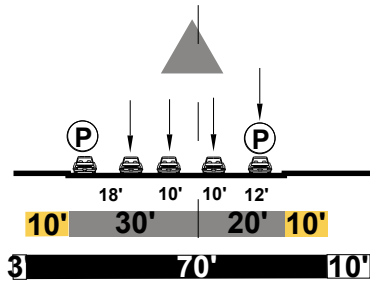

Maple - Wall

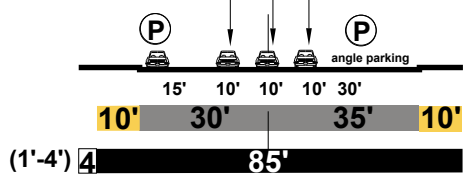

Wall - San Pedro

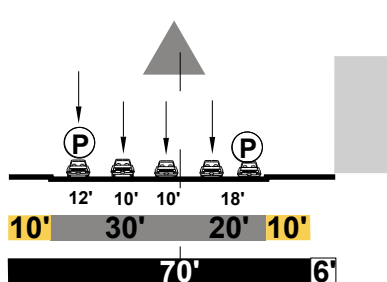

PROPOSED

Hill - alley bet. Hill/Broadway

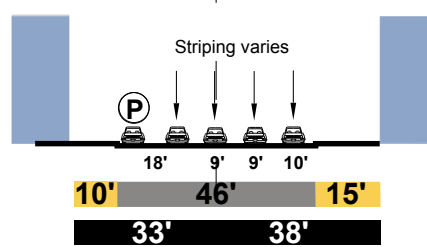

alley bet. Hill/Broadway - Main

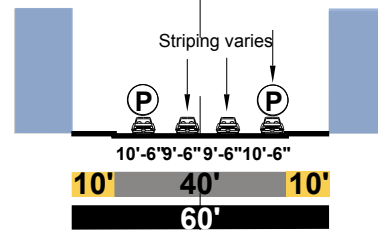

Main - Los Angeles

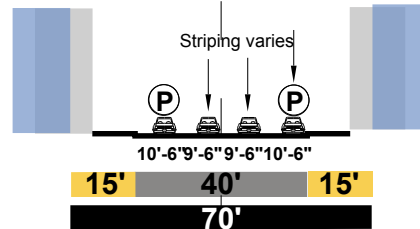

Los Angeles - San Pedro

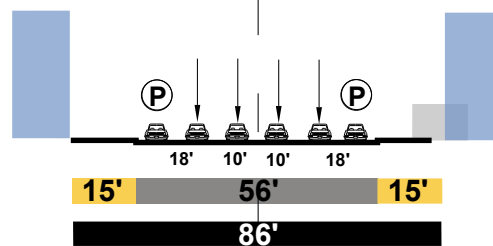

WILSHIRE BOULEVARD looking west
EXISTING
 Major Class II west of Figueroa
 Secondary east of Figueroa

PROPOSED
 Modified Avenue I east of Figueroa
 Modified Avenue II from Figueroa to Flower St
 Avenue II from Flower St to Grand Ave

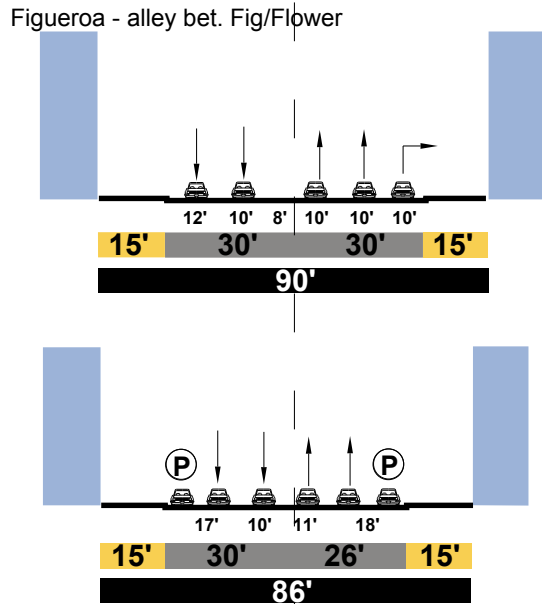
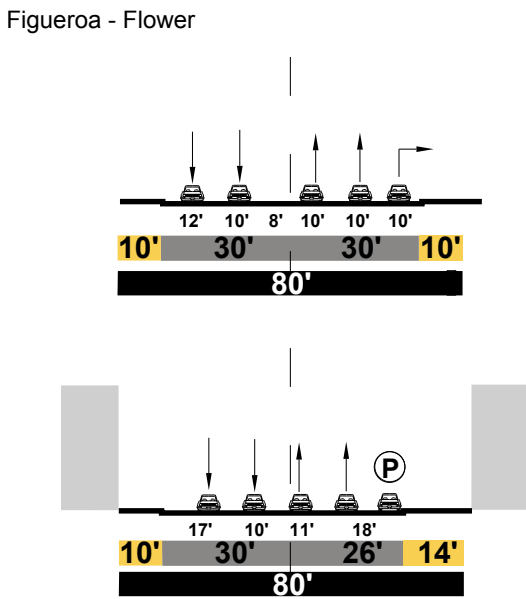
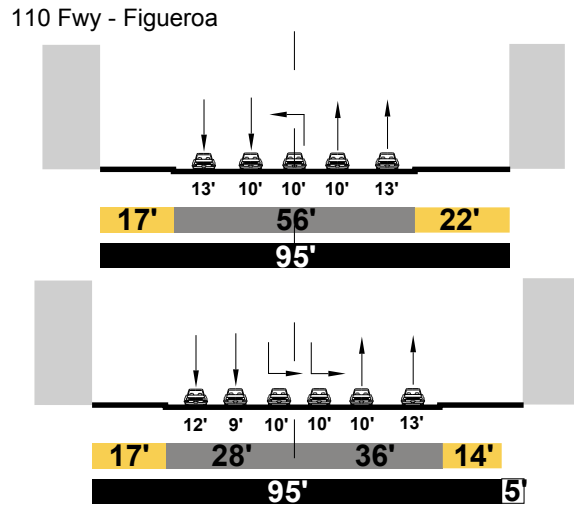
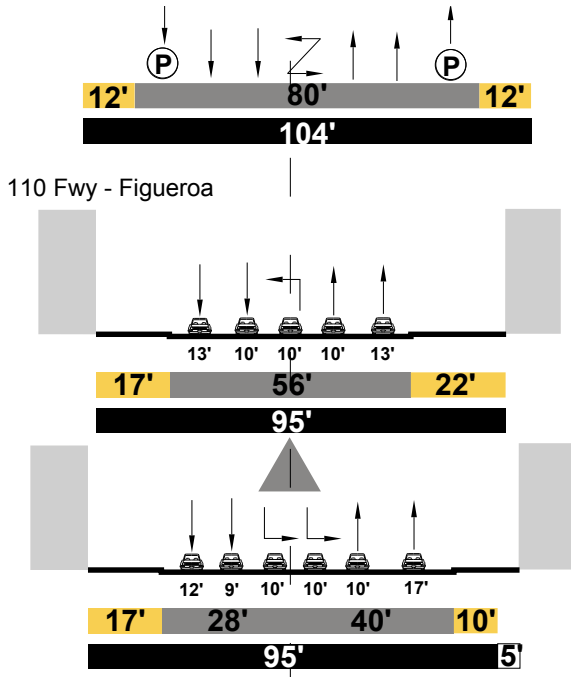

WILSHIRE BOULEVARD looking west (continued)
EXISTING

PROPOSED

Flower - Hope

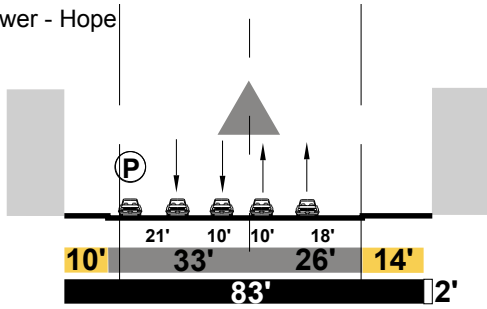

Flower - Hope

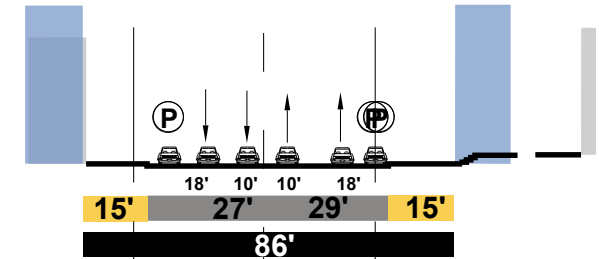
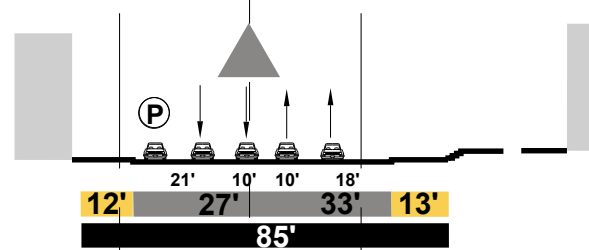
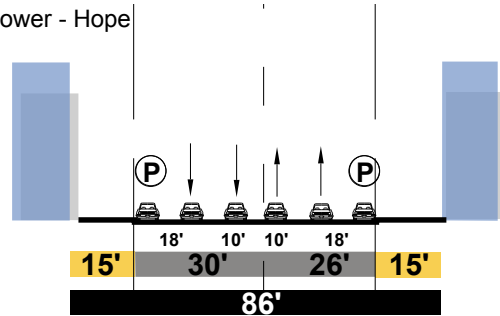

Hope - Grand

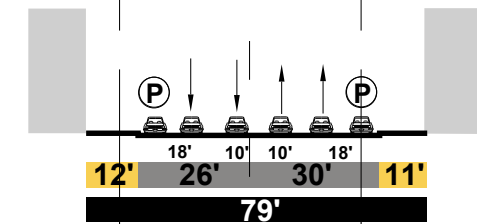

Hope - Grand

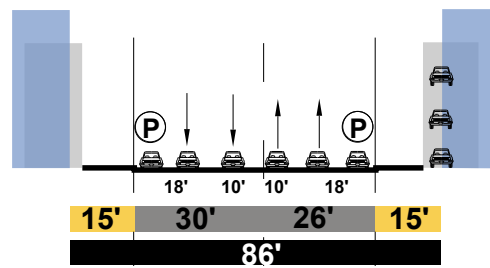
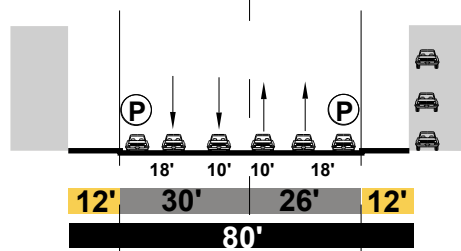
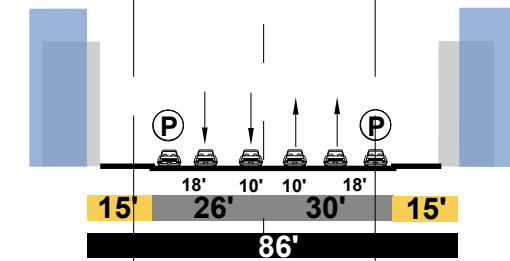

7TH STREET looking west
EXISTING
 Secondary

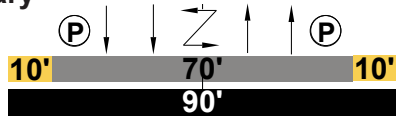

110 Fwy - Figueroa

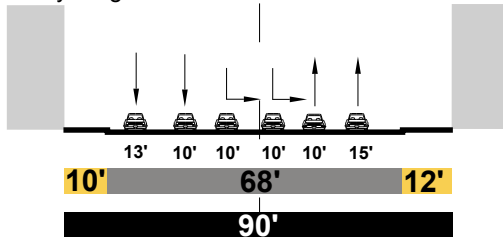

Figueroa - 100' east of Los Angeles

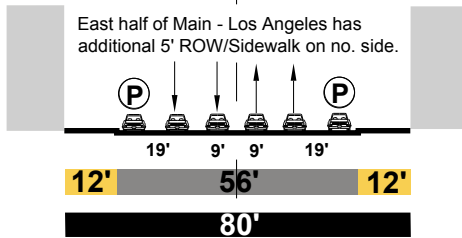

100' east of Los Angeles - Maple

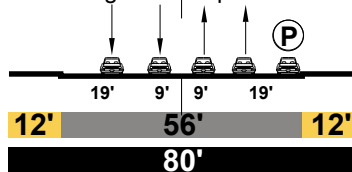

Maple - Wall

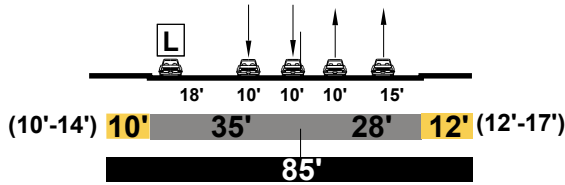

Wall - San Pedro

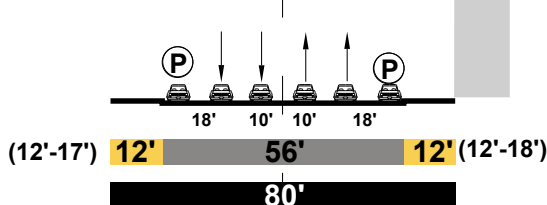

PROPOSED

Modified Avenue II west of Los Angeles St
Avenue II east of Los Angeles St

110 Fwy - Figueroa

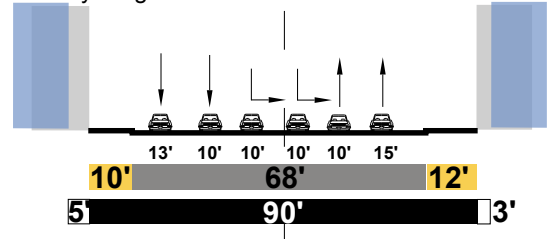

Figueroa - 100' east of Los Angeles

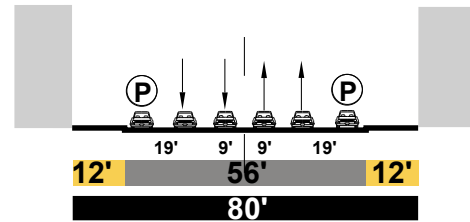

100' east of Los Angeles - San Pedro

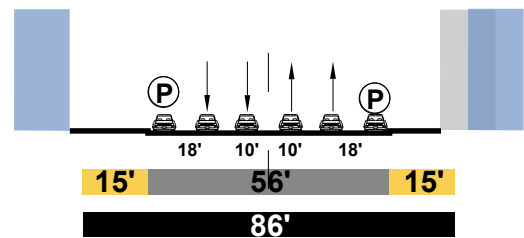

▲ **ALTERNATIVE with bicycle lanes**
 110 Fwy - Figueroa

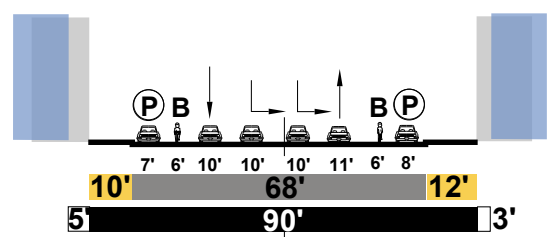

Figueroa - 100' east of Los Angeles

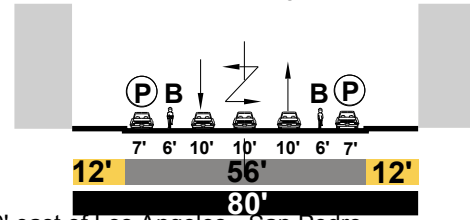

100' east of Los Angeles - San Pedro

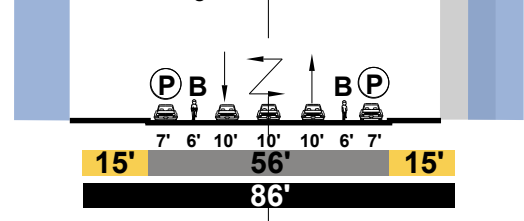

8TH STREET looking west
EXISTING
 Secondary

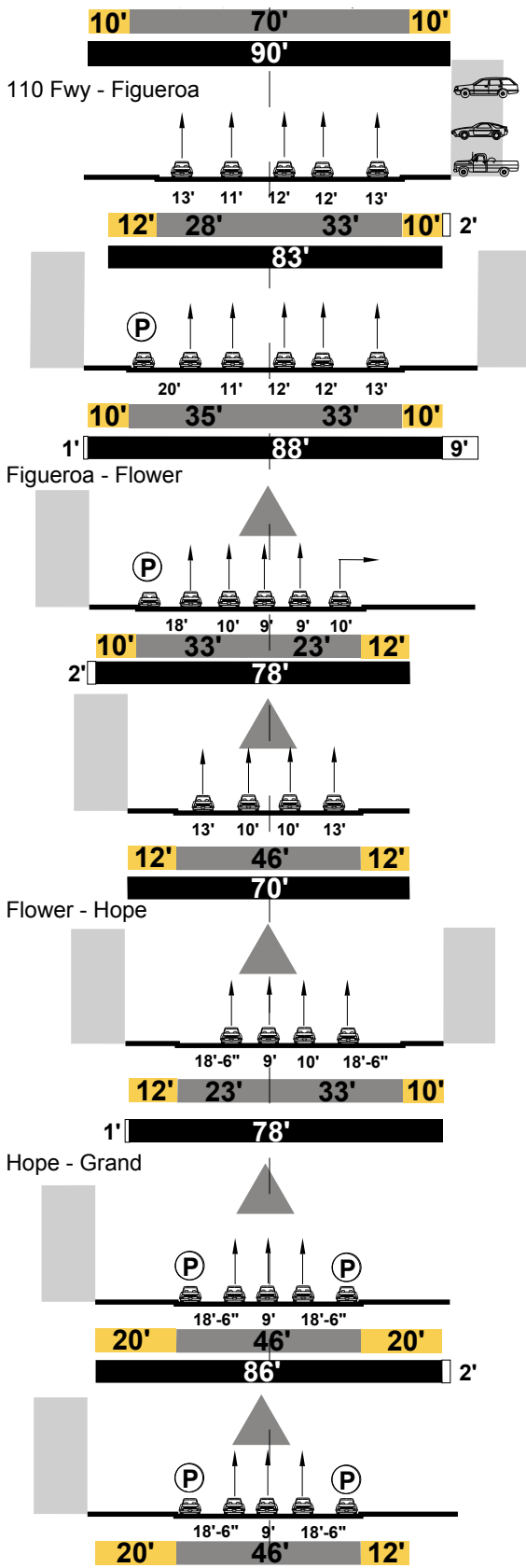

PROPOSED
 Modified Avenue II east of Olive St
 Modified Avenue III from Olive St to Main St
 Avenue II east of Main St

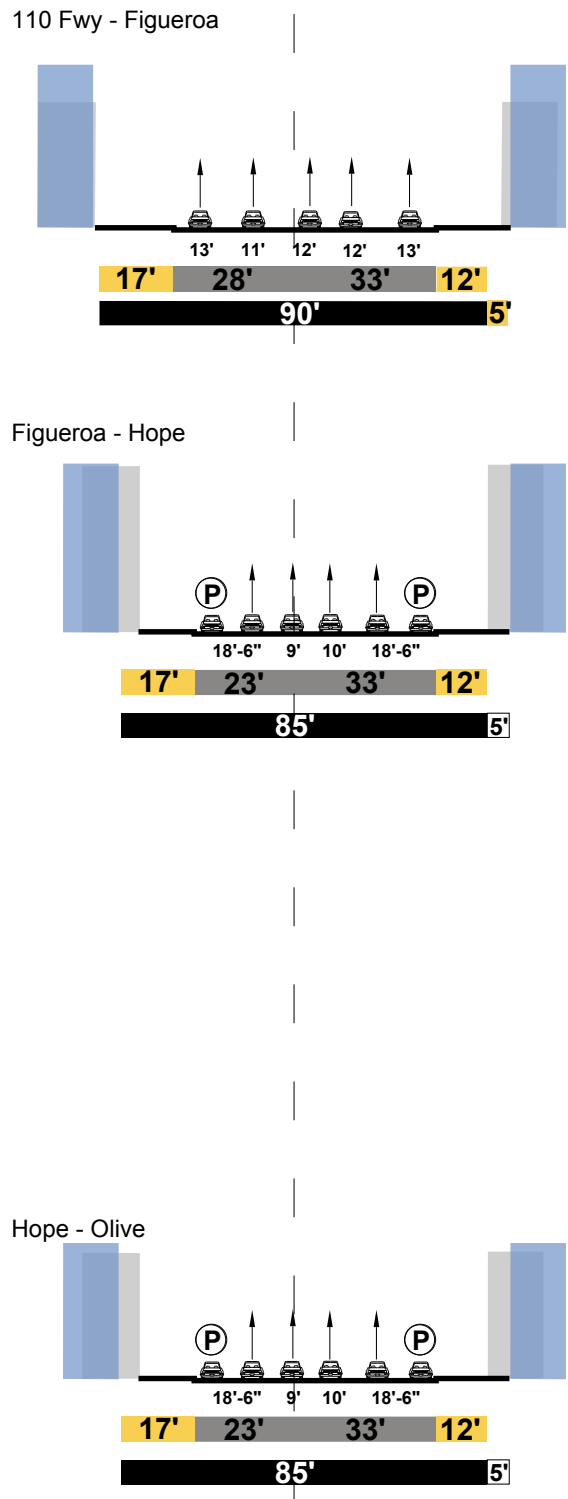

8TH STREET looking west (continued)
EXISTING

PROPOSED

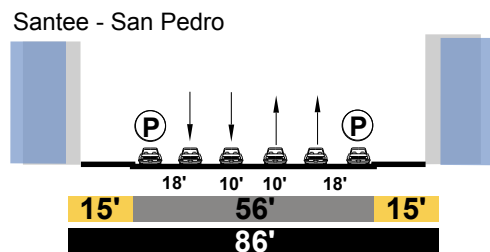
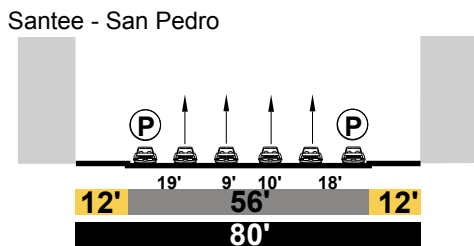
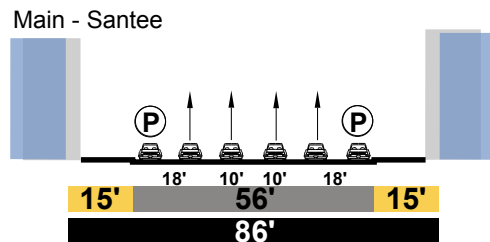
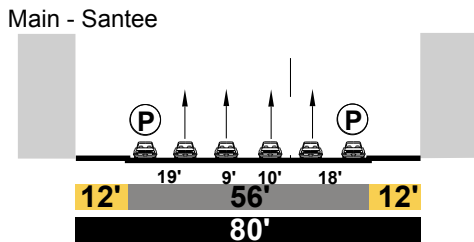
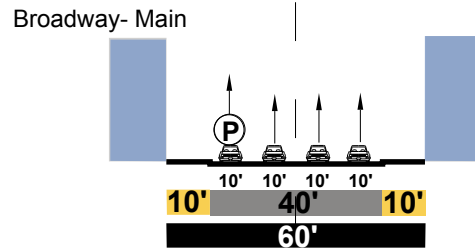
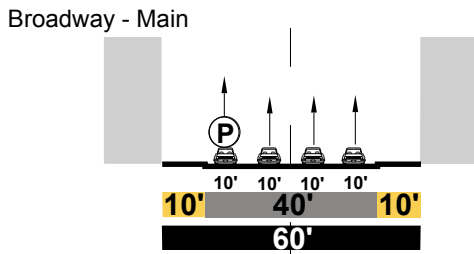
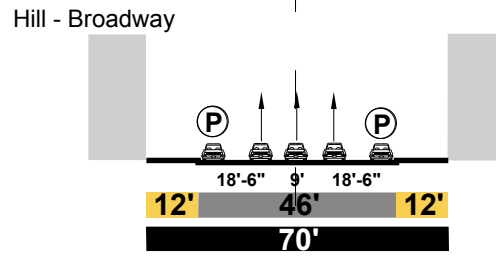
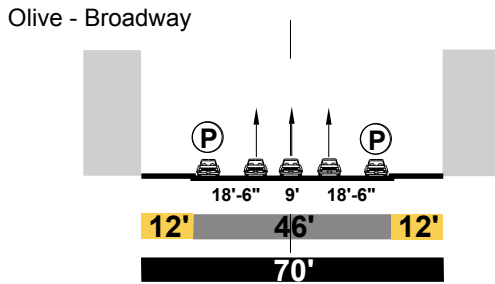
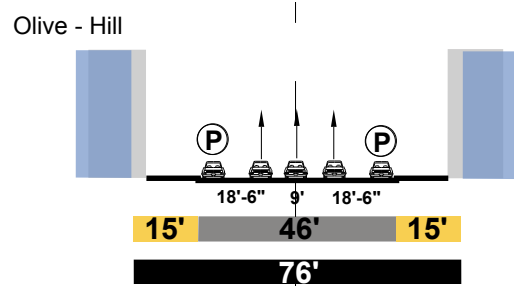
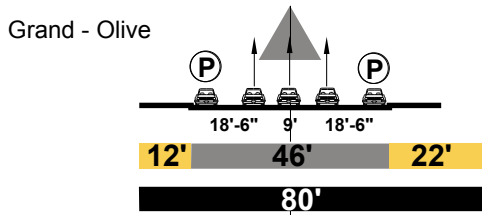

JAMES WOOD/9TH STREET looking west

EXISTING
Secondary

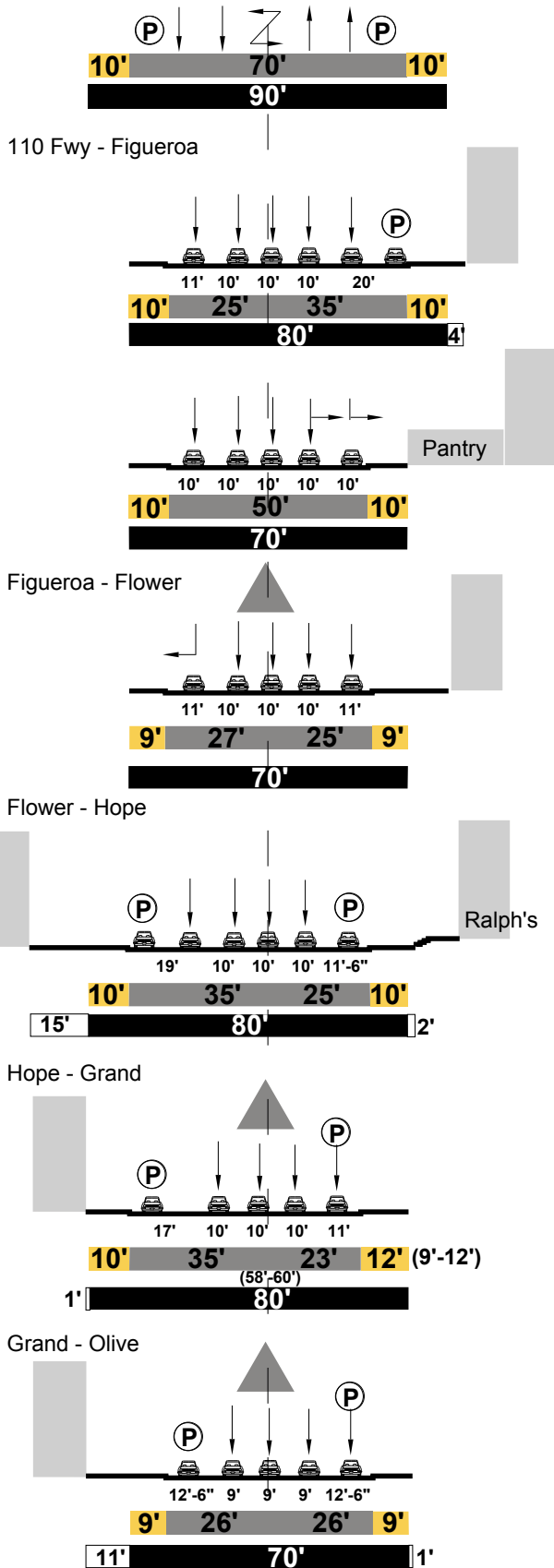

PROPOSED

Modified Avenue II from 110 FWY to Olive St
Modified Avenue III from Olive St to Spring St
Avenue II from Main St to Judge John Aliso
Avenue I east of Judge John Aliso

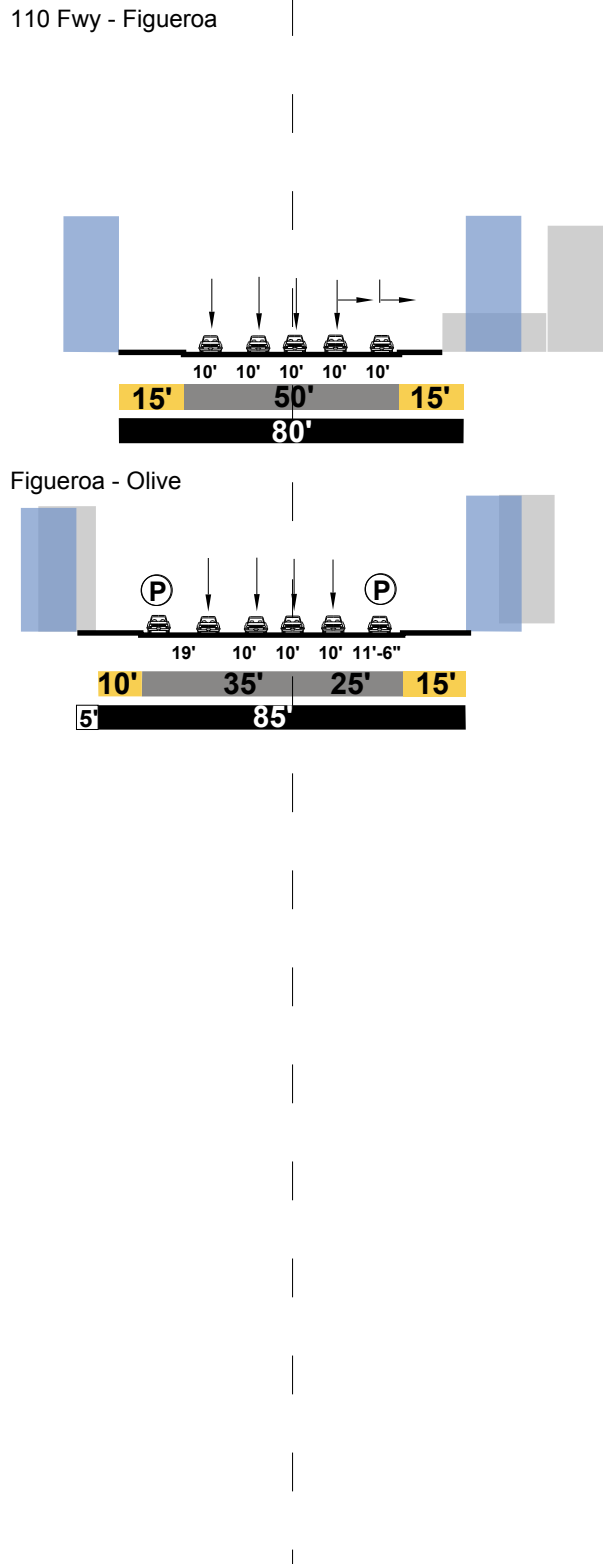

9TH STREET looking west (continued)
EXISTING

PROPOSED

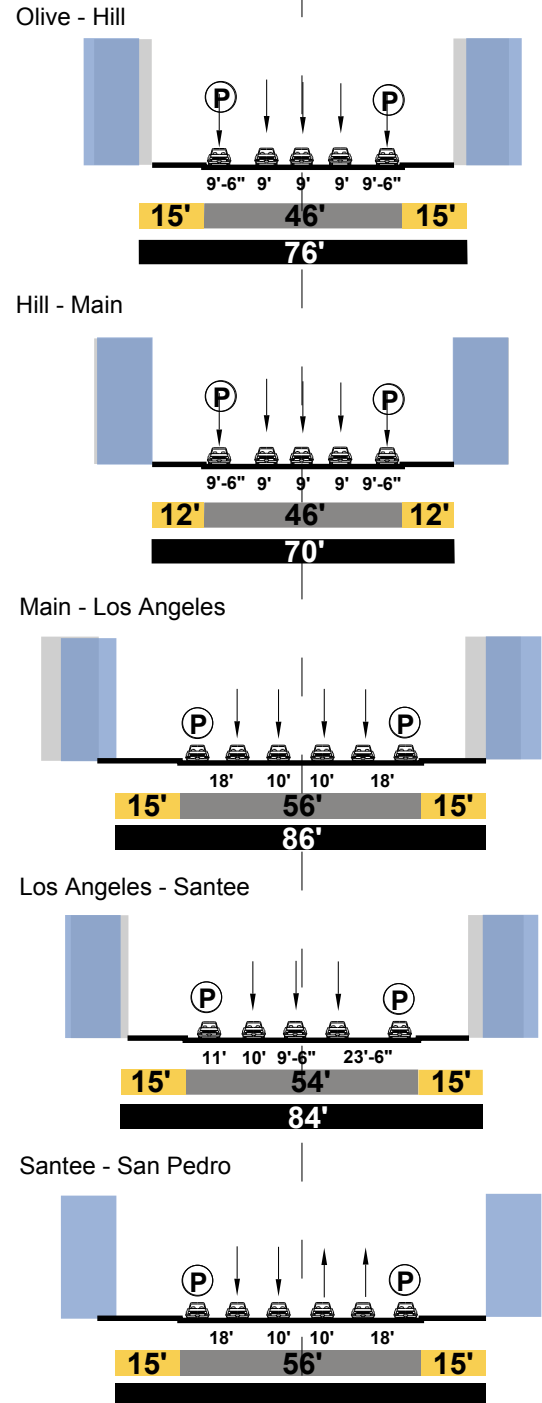
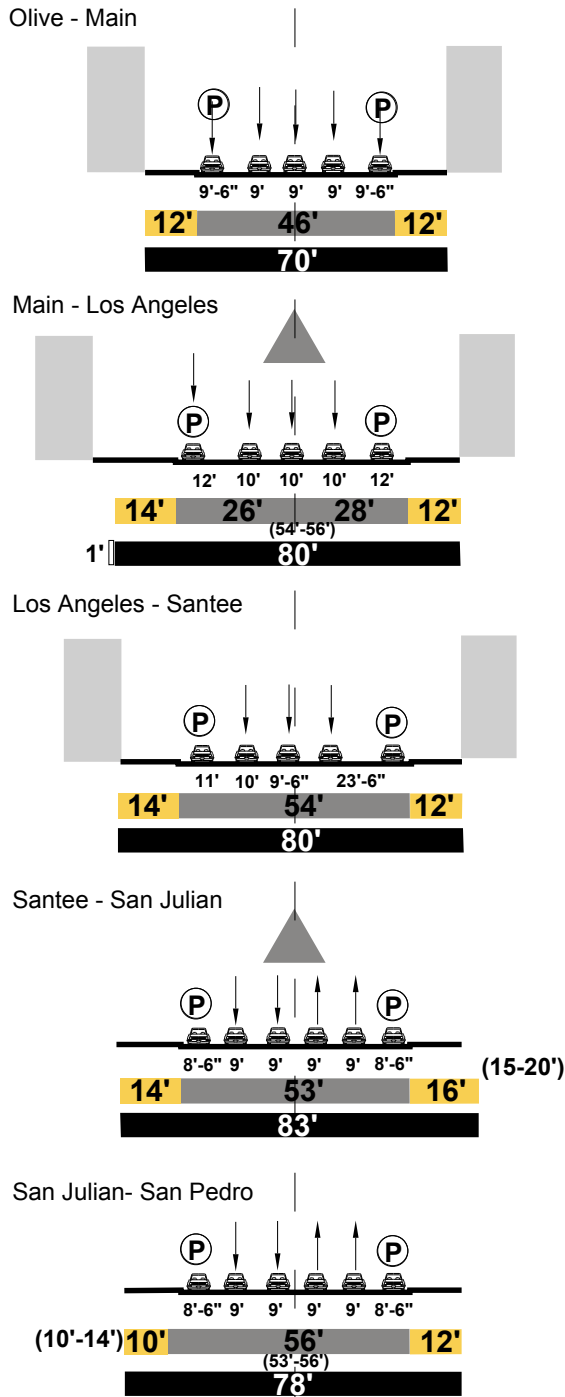

OLYMPIC BOULEVARD looking west
EXISTING

Major Class II

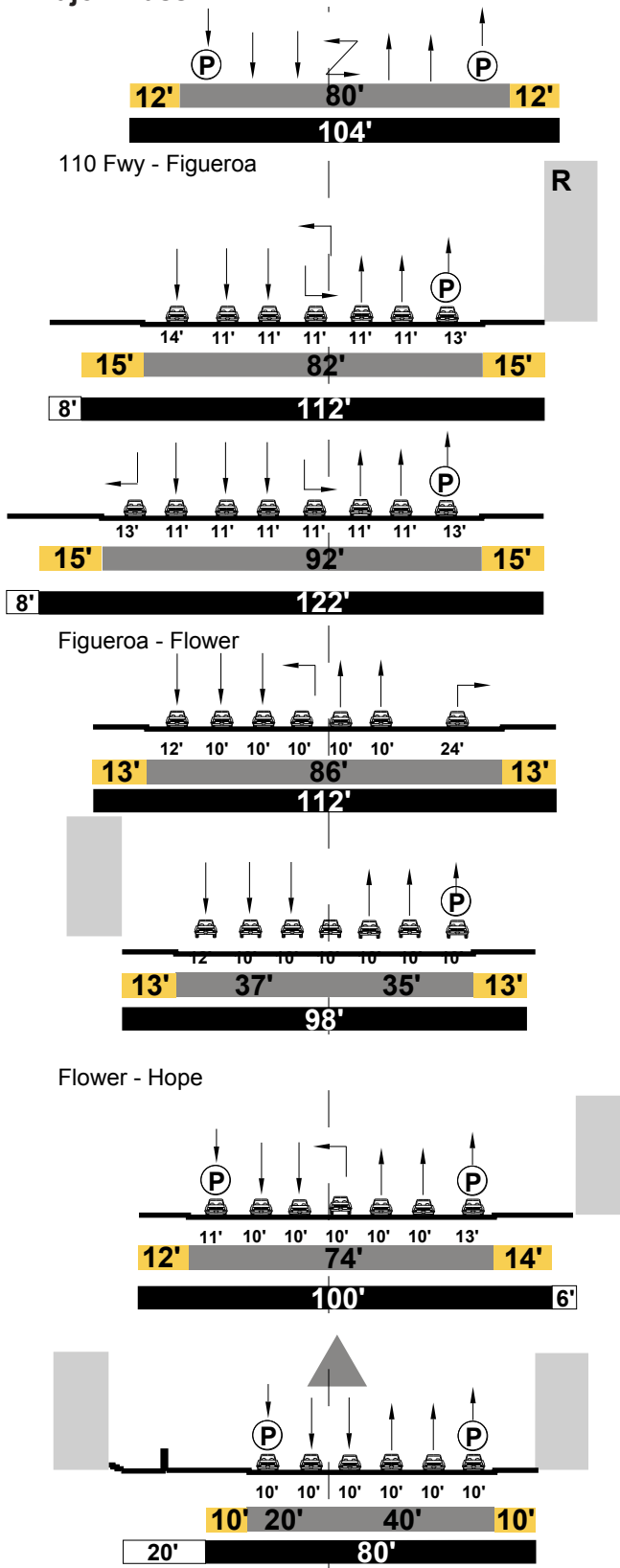

PROPOSED

Boulevard II east of Flower St; Broadway to Maple Ave
Modified Boulevard II from Flower St to Hope St
Modified Avenue I from Hope St to Broadway
Modified Avenue III from Maple Ave to San Julian St

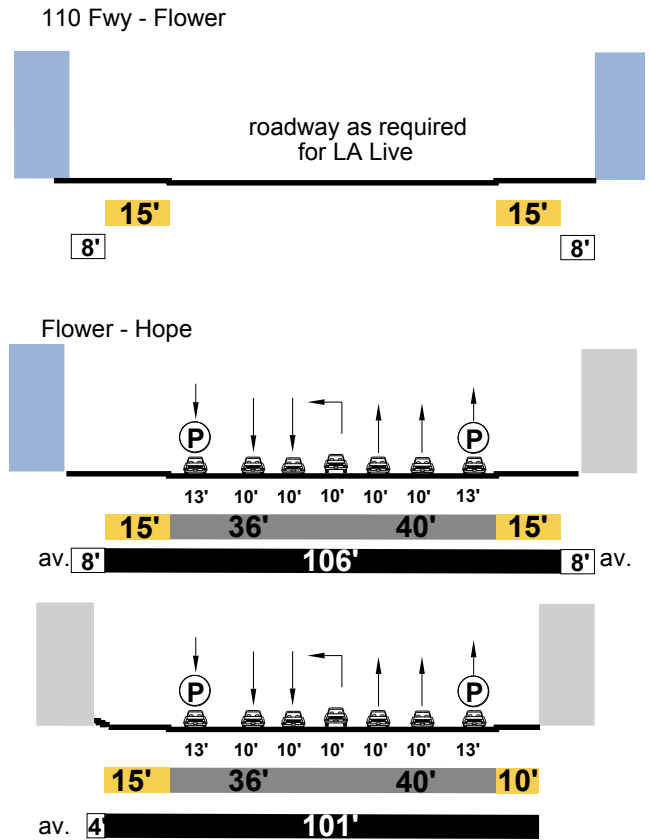

OLYMPIC BOULEVARD looking west (continued)
EXISTING

PROPOSED

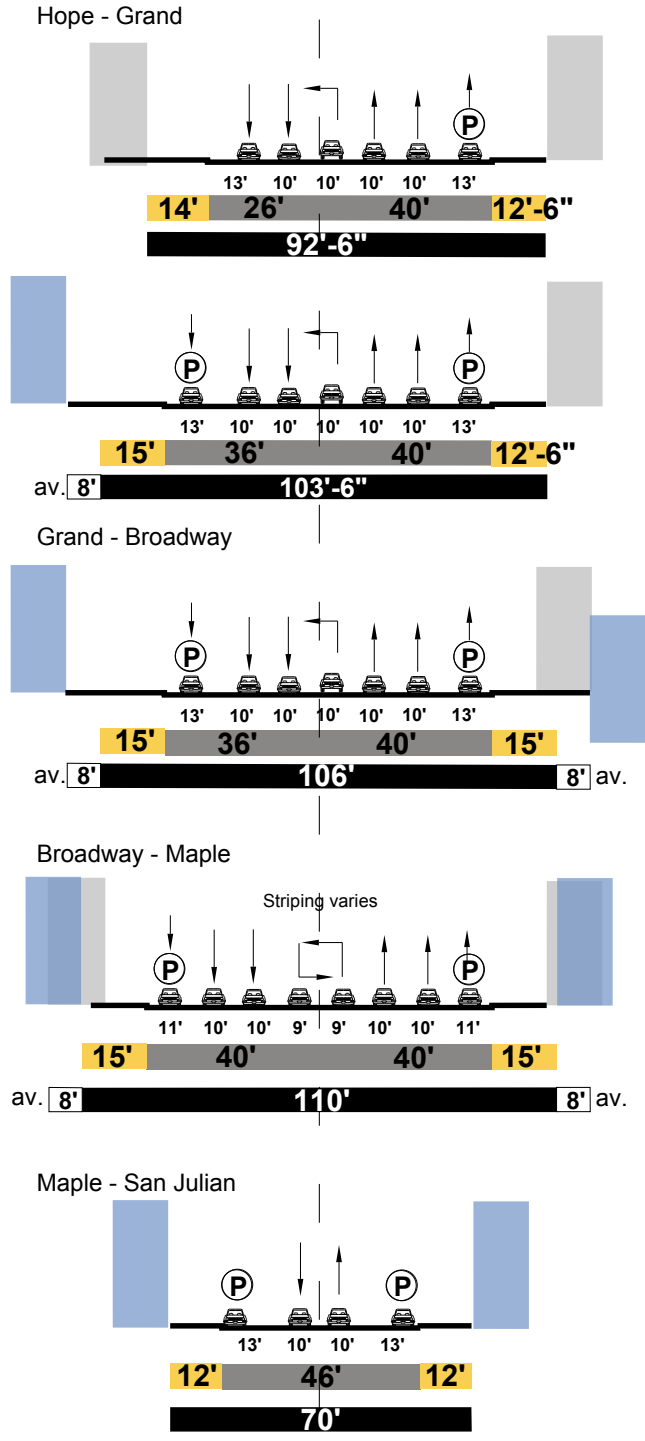
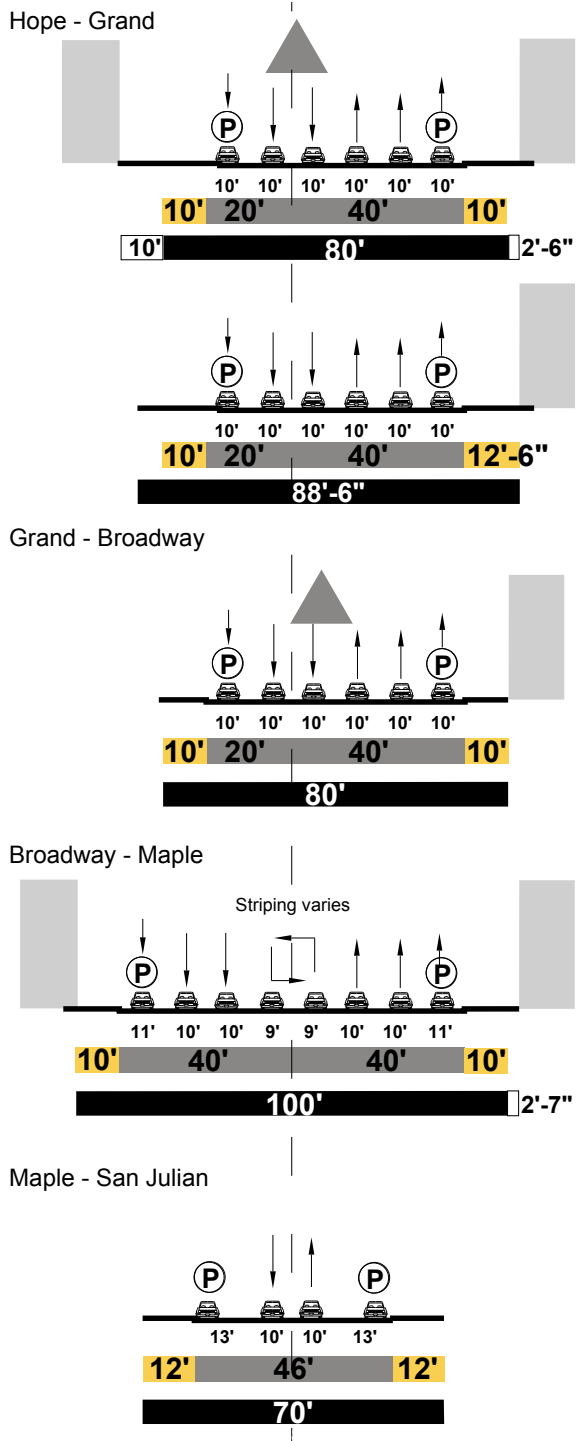

CHICK HERN COURT/11TH STREET looking west

**EXISTING
Collector**

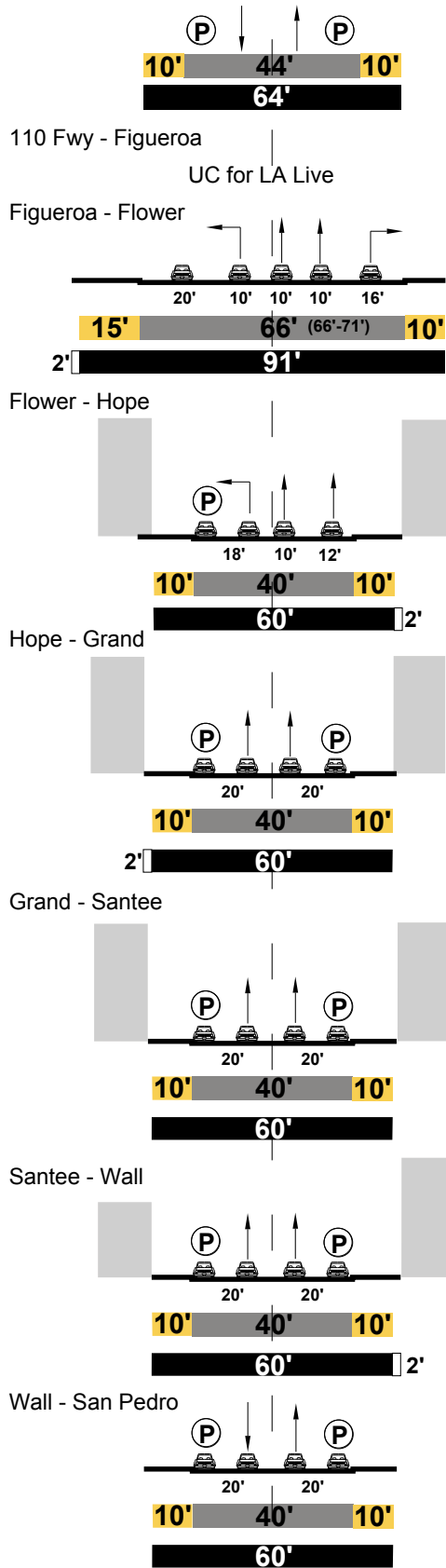

**PROPOSED
Modified Collector Street**

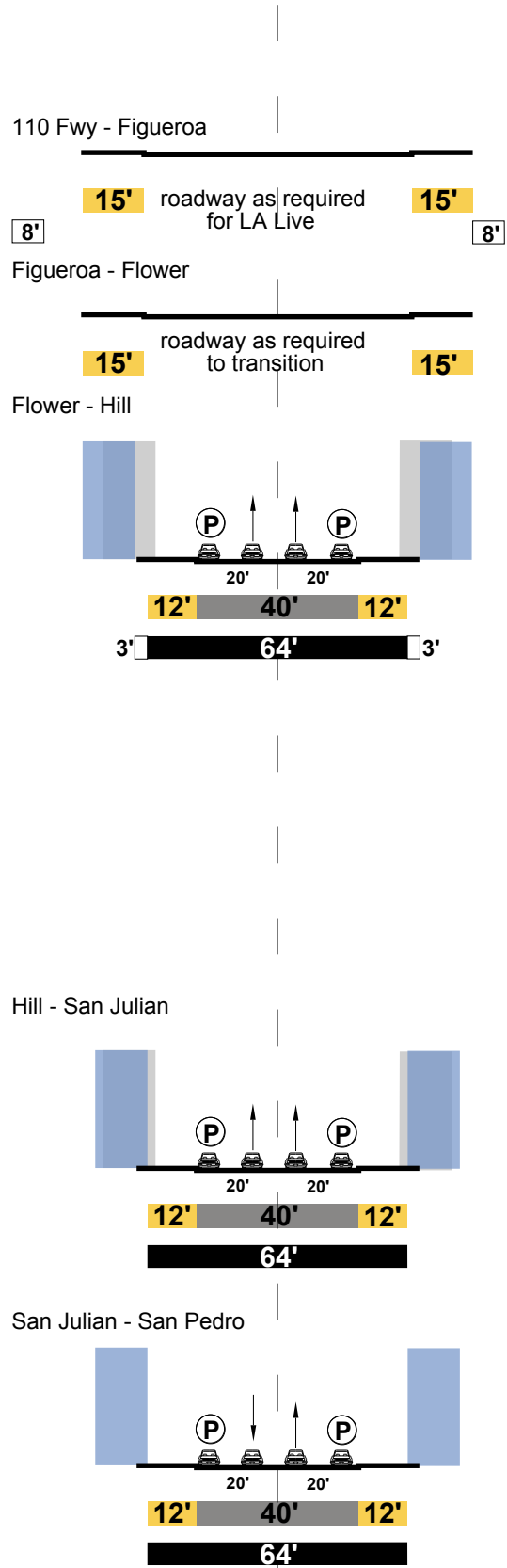

12TH STREET looking west
EXISTING
Collector

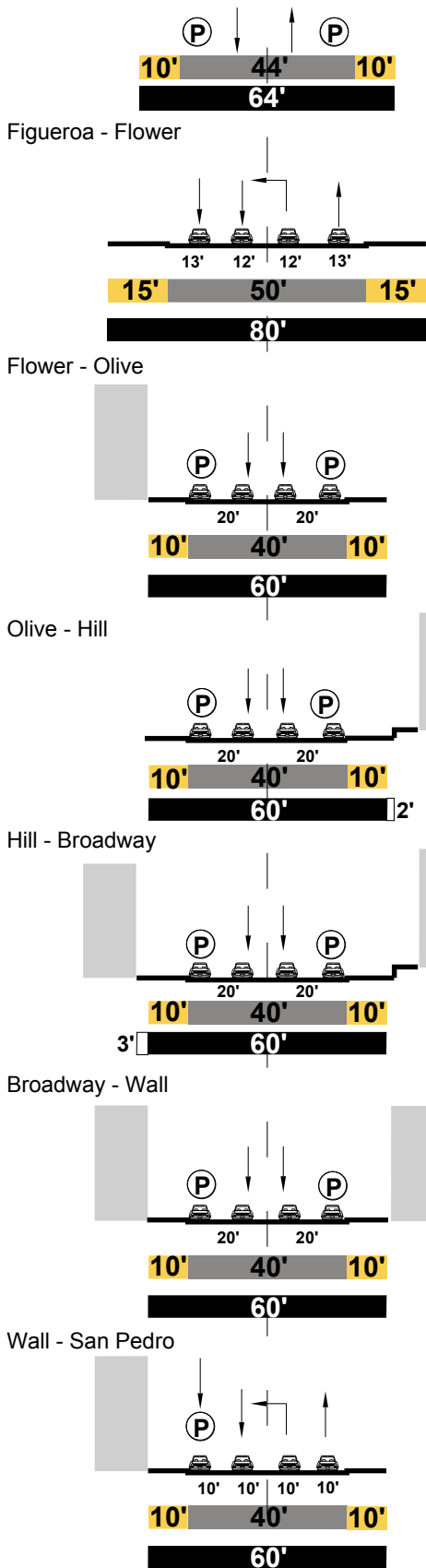

PROPOSED
Avenue II from Figueroa to Flower St
Modified Collector Street east of Flower St



PICO BOULEVARD looking west
EXISTING
 Secondary

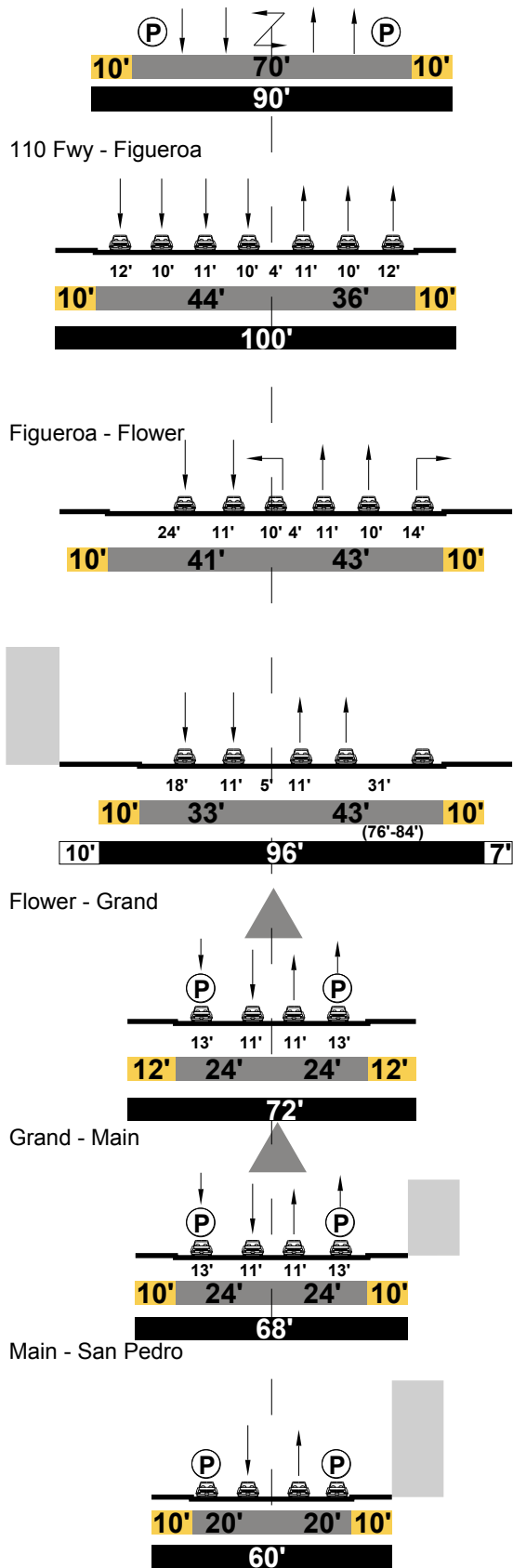

PROPOSED

Modified Avenue II from 110 Fwy to Figueroa
 Modified Boulevard II from Figueroa to Flower St
 Avenue I from Flower St to Broadway
 Modified Avenue III from Broadway St to Main St
 Modified Local Street - Standard from Main St to San Pedro St
 Local Street - Standard from San Pedro St to Stanford Ave
 Collector Street from Stanford Ave to Central Ave

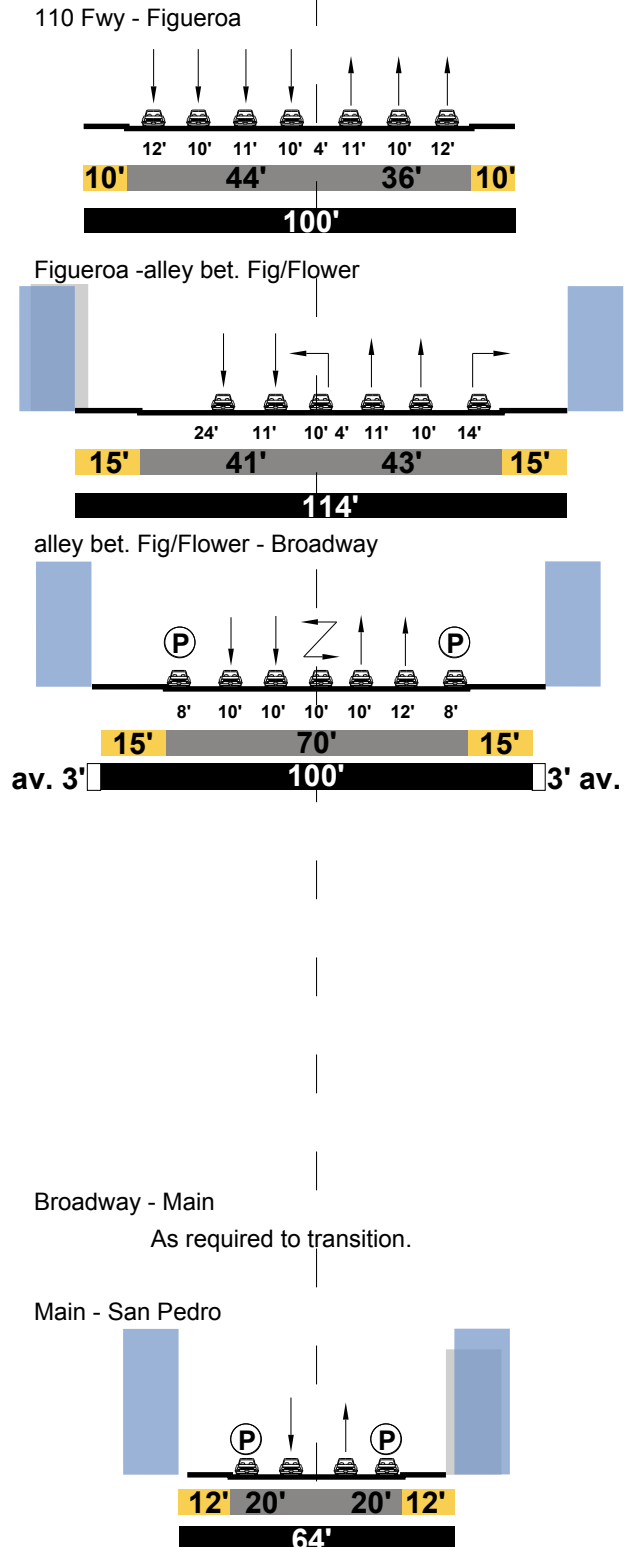

14TH STREET looking west
EXISTING
 Local

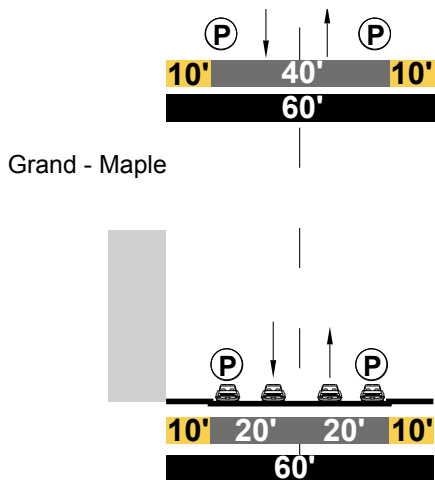

PROPOSED
 Modified Local Street - Standard from Grand Ave to Maple St
 Avenue III from San Pedro St to Central Ave

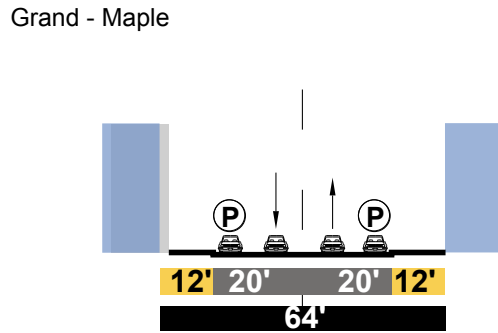

15TH STREET looking west
EXISTING
 Collector

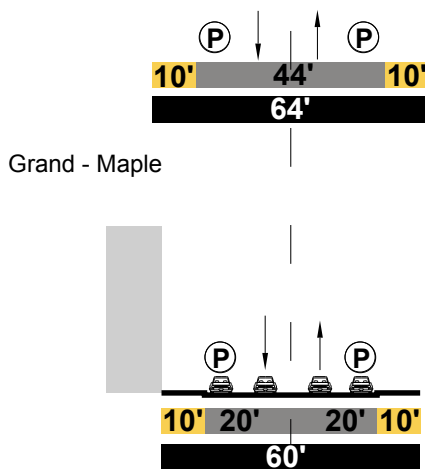

PROPOSED
 Modified Local Street from Grand Ave to Maple Ave
 Collector from Maple Ave to San Pedro St
 Local Street - Standard from San Pedro St to Hooper Ave
 Avenue II from Hooper Ave to Alameda St

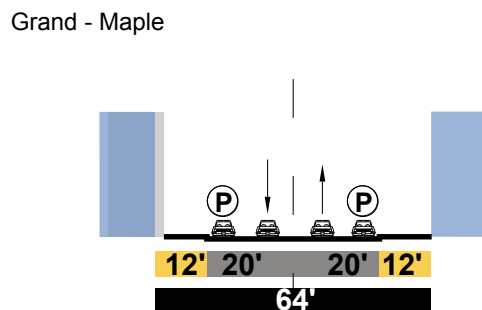

VENICE BOULEVARD looking west
EXISTING
 Secondary

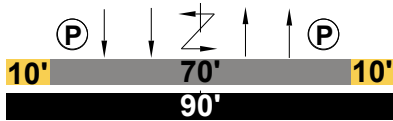

PROPOSED WITH BICYCLE LANES
 Modified Avenue II from 110 FWY to San Pedro
 Avenue II from San Pedro to Hooper Ave
 Local Street - Standard east of Hooper Ave

110 Fwy - Figueroa

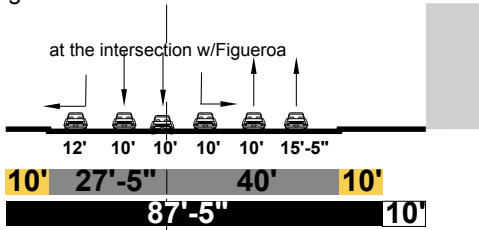

110 Fwy - Figueroa

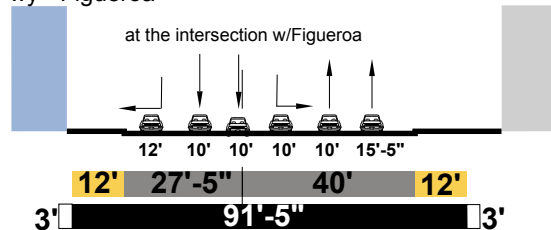

Figueroa - Hope

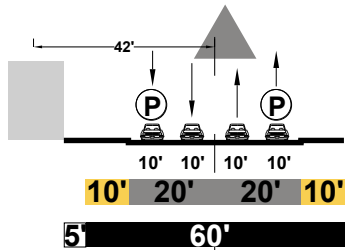

Figueroa - Hope

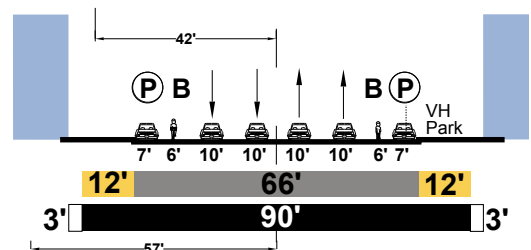

Hope - Grand

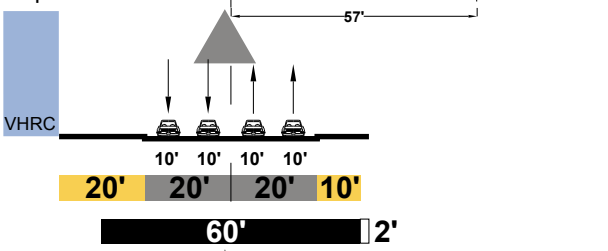

Hope - Grand

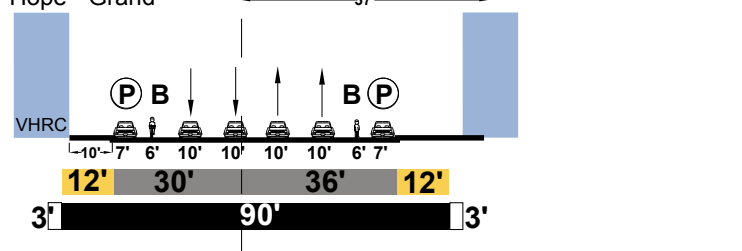

Grand - Olive

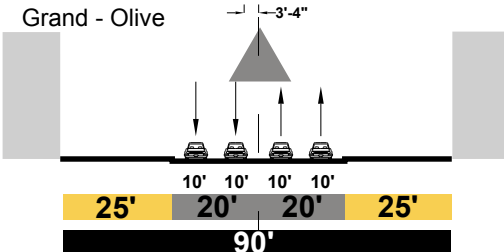

Grand - San Pedro

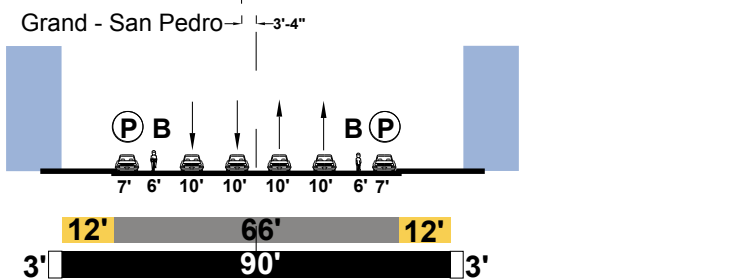

Olive - San Pedro

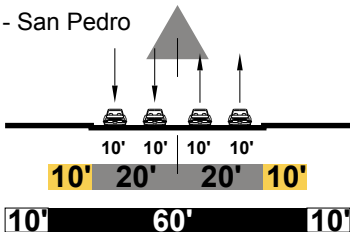

LOCAL STANDARD STREETS LIVING STREETS

The following streets, as shown in the table and the map below, have been re-designated from collectors to local standard streets. Improvements to these streets should conform to the standards for local streets or to the "Living Streets" design concept as illustrated on the following page. The living street option may be appropriate for these streets - whole block development or comprehensive street design project.

Street Name	From	To
Seaton St.	4th St.	Palmetto St.
Colyton St.	4th St.	Palmetto St.
Hewitt St.	4th St.	Palmetto St.
Molino St.	4th St.	Palmetto St.
4th Pl.	Molino St.	4th St.
Palmetto St.	Alameda St.	Santa Fe Ave.
Factory Pl.	Alameda St.	Mateo St.
Willow St.	Mateo St.	Santa Fe Ave.
Mill St.	6th St.	7th St.
Imperial St.	6th St.	7th St.
Mesquit St.	6th St.	7th St.
Industrial St.	Alameda St.	Mateo St.
Jesse St.	Mateo St.	Mesquit St.
Channing St.	7th St.	7th Pl.
Lawrence St.	7th St.	7th Pl.
Lawrence St.	Bay St.	8th St.
Decatur St.	7th St.	7th Pl.
Wilson St.	7th St.	Sacramento St.
Lemon St.	8th St.	E. Olympic Blvd
7th Pl.	Wilson St.	East of Santa Fe Ave.
Violet St.	Wilson St.	East of Santa Fe Ave.
Bay St.	Wilson St.	East of Santa Fe Ave.
Sacramento St.	Lawrence St.	East of Santa Fe Ave.
8th St.	Alameda St.	Lemon St.
8th St.	West of Mateo St.	East of Santa Fe Ave.
Damon St.	Lemon St.	Mateo St.
Enterprise St.	Lemon St.	Mateo St.

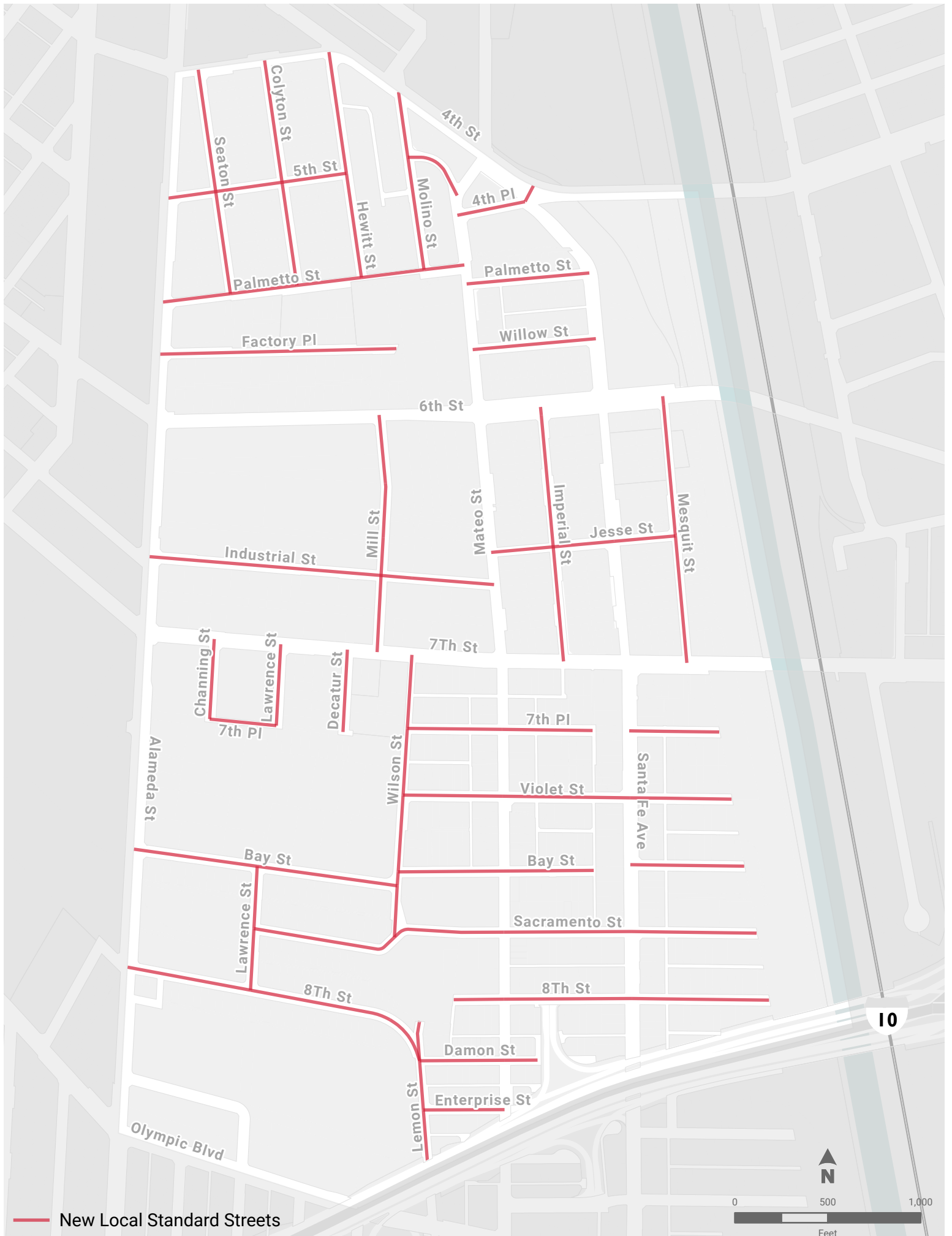

**LOCAL STANDARD STREETS:
RECOMMENDED DESIGN OPTIONS**

The following cross sections and design concepts represent recommended options for local standard streets shown in the table and map on the previous page. Living Street design may be appropriate for when whole block developments or comprehensive street design projects occur.

Living Streets offer a new street configuration that lays out suggested dimensions and design strategies that can be incorporated for streets that are approximately 60' wide and typically extend for only a short number of blocks. Projects that are interested in pursuing a similar design strategy should contact City Planning's Urban Design Studio for a consultation.

Proposed Local Standard Street

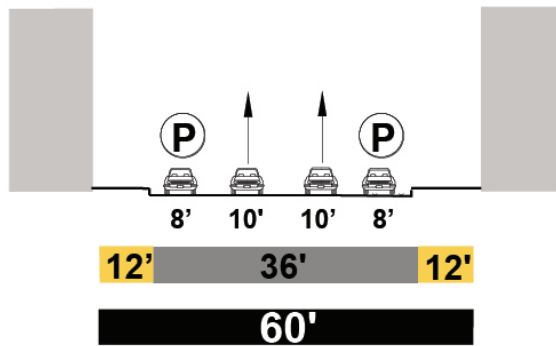

Proposed Local Standard Living Street

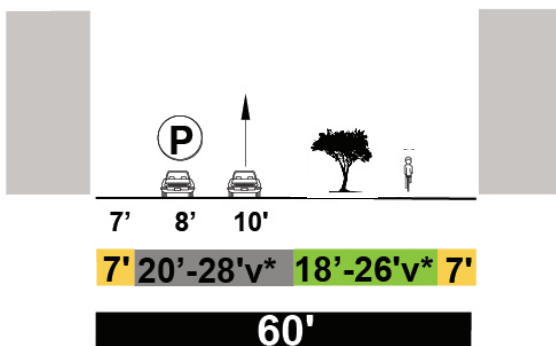

** travel lane and parkway width varies*

LIVING STREETS

Plan view and cross sections are illustrative, final design to be decided at the individual project level.

Roadway: Vehicular travel lanes are 10' wide to promote slower speeds and caution. Marked sharrows are the typical bicycle facility.

Accessibility: New concrete curbs have a 1/4" high vertical face to provide a detectable edge for the visually impaired and sidewalks are 7' min. wide.

Back-of-curb: Generous, 7'-25' wide spaces may be programmed for seating, cafe tables, etc. Plain concrete is typical, porous pavers optional.

Water management: 10' or wider raingardens provide the space needed for larger shade trees and capture run-off from downspouts and walks.

Living Street Conceptual Plan Vieww

